

Copyright

This document is Copyright © 2024 by the LibreOffice Documentation Team. Contributors are listed below. You may distribute it and/or modify it under the terms of either the GNU General Public License (<https://www.gnu.org/licenses/gpl.html>), version 3 or later, or the Creative Commons Attribution License (<https://creativecommons.org/licenses/by/4.0/>), version 4.0 or later.

All trademarks within this guide belong to their legitimate owners.

Contributors

To this edition

Jean Hollis Weber, Claire Wood, Luciana Motta, B. Antonio Fernández, Olivier Hallot, Timothy Brennan Jr., Vítor Ferreira, Rafael Lima, Rob Thornton, Edward Olson, Peter Schofield.

To previous editions

Skip Masonsmith, flywire, Nay Catina Dia-Schneebeli, Mitchell Camfield, Rafael Lima, Felipe Viggiano, Steve Fanning, Jean Hollis Weber, Andrew Jensen, Amanda Labby, Cathy Crumbley, Dan Lewis, Dave Barton, Pulkit Krishna, Jorge Rodriguez, Olivier Hallot, Paul Figueiredo, Peter Schofield, Kees Kriek, Martin Saffron, Steve Schwettman, Dave Barton, Hazel Russman, Ron Faile Jr., Kevin O'Brien, Magnus Adielsson, Iain Roberts, JiHui Choi, Regina Henschel, Laurent Balland-Poirier, Christian Kühn, Florian Reisinger, Gisbert Friege (Dmaths), Jochen Schiffers, Frédéric Parrenin, Bernard Siaud, Miklos Vajna, Valerii Goncharuk, Andrew Pitonyak, Claire Wood, John A Smith, Roman Kuznetsov, Vasudev Narayanan, Vlada Slavitskaya.

Feedback

Please direct any comments or suggestions about this document to the Documentation Team's forum at <https://community.documentfoundation.org/c/documentation/loguides/> (registration is required) or send an email to: loguides@community.documentfoundation.org.

Note

Everything you send to a mailing list or forum, including your email address and any other personal information that is written in the message, is publicly archived and cannot be deleted.

Publication date and software version

Published August 2024. Based on LibreOffice Community.
Other versions of LibreOffice may differ in appearance and functionality.

Contents

Copyright.....	2
Preface.....	9
Who is this user guide for?.....	10
What is in this user guide?.....	10
What is LibreOffice?.....	10
Advantages of LibreOffice.....	11
Minimum requirements for using LibreOffice.....	12
Java software.....	12
How to get LibreOffice.....	13
Installing LibreOffice.....	13
Setting up and customizing LibreOffice.....	13
Extensions.....	13
Where to get more help.....	13
What you see may be different.....	16
Using LibreOffice on macOS.....	17
What are all these things called?.....	18
Who wrote this user guide?.....	19
Frequently asked questions.....	19
What is new in LibreOffice 24.8?.....	20
Chapter 1, LibreOffice Basics.....	21
Getting Started.....	22
Main LibreOffice window.....	24
Working with documents.....	31
Printing.....	36
Using Safe Mode.....	47
Chapter 2, Getting Started with Writer.....	51
What is Writer?.....	52
The Writer interface.....	52
Changing document views.....	57
Working with documents.....	57
Working with text.....	60
Formatting text.....	71
Formatting pages.....	78
Adding comments to a document.....	83
Using built-in language tools.....	84
Creating a table of contents.....	86
Creating indexes and bibliographies.....	86
Using footnotes and endnotes.....	86
Inserting material from other documents.....	87
Working with images (graphics).....	87
Working with tables.....	87
Printing and exporting to PDF or EPUB.....	88
Using mail merge.....	88
Tracking changes to a document.....	88
Using fields.....	89
Linking and cross-referencing within a document.....	89
Using master documents.....	91
Creating fill-in forms.....	91
Using content controls.....	91
Determining document accessibility.....	92
Chapter 3, Getting Started with Calc.....	93

What is Calc?.....	94
Compatibility with other spreadsheet applications.....	94
Spreadsheets, sheets, and cells.....	95
Calc main window.....	95
Opening and importing a CSV file.....	100
Saving spreadsheets.....	101
Importing external data – Web Query.....	104
Navigating within spreadsheets.....	105
Selecting items in a spreadsheet.....	108
Working with columns and rows.....	111
Working with sheets.....	112
Viewing a spreadsheet.....	115
Entering data using the keyboard.....	117
Speeding up data entry.....	122
Sharing content between sheets.....	125
Validating cell contents.....	126
Editing data.....	126
Formatting data.....	128
Using AutoFormat on cells.....	134
Using themes.....	135
Using conditional formatting.....	137
Filtering data.....	137
Cell protection.....	137
Sorting records.....	138
Cell comments.....	139
Using formulas and functions.....	140
Analyzing data.....	141
Pivot tables and pivot charts.....	141
Printing.....	142
Chapter 4, Working with Styles, Templates, and Hyperlinks.....	147
Introduction.....	148
Styles.....	148
Templates.....	160
Hyperlinks.....	167
Chapter 5, Working with Images and Graphics.....	171
Introduction.....	172
Images and graphics.....	172
Editing images or graphics.....	176
LibreOffice Gallery.....	182
Creating image maps.....	186
LibreOffice drawing tools.....	188
Grouping objects.....	190
Fontwork.....	192
Barcodes and QR codes.....	194
Chapter 6, Getting Started with Impress.....	197
What is Impress?.....	198
Starting Impress.....	198
Main Impress window.....	199
Workspace views.....	205
Creating presentations.....	209
Adding and formatting text.....	214
Inserting images, tables, charts, or media.....	223
Working with master slides.....	228

Adding comments.....	235
Printing handouts.....	235
Creating a photo album.....	238
Presentations (slide shows).....	239
Chapter 7, Getting Started with Draw.....	247
Introduction.....	248
Main window.....	248
Drawing basic shapes.....	253
Gluepoints and connectors.....	261
Geometric shapes.....	262
Adding and formatting text.....	265
Selecting objects.....	268
Positioning and adjusting objects.....	269
Grouping and combining multiple objects.....	275
Inserting and exporting images.....	277
Working with 3D objects.....	278
Working with layers.....	278
Selecting colors.....	280
Adding comments to a drawing.....	282
Chapter 8, Getting Started with Base.....	283
Introduction.....	284
Planning a database.....	285
Using the Database Wizard to create a new database.....	287
Creating database tables.....	289
Creating a database form.....	299
Modifying a form.....	302
Entering data in a form.....	316
Creating queries.....	319
Creating reports.....	326
Accessing other data sources.....	329
Using data sources in LibreOffice.....	330
Chapter 9, Getting Started with Math.....	337
Introduction.....	338
Getting started.....	338
Creating formulas.....	340
Editing formulas.....	344
Formula layout.....	345
Changing formula appearance.....	351
Building a formula library.....	359
Formulas in Writer.....	360
Formulas in Calc, Draw, and Impress.....	365
Customization.....	367
Exporting and Importing.....	370
Chapter 10 Working with File Formats, Security, and Exporting.....	373
File formats.....	374
File formats for saving.....	376
Exporting files.....	377
EPUB format export (Writer only).....	388
Creating HTML files.....	391
HTML files using Writer/Web.....	394
Emailing documents.....	398
Files on remote servers.....	398
Digital signatures.....	399

Document properties.....	402
Document classification.....	406
User and personal data.....	408
Redaction.....	409
Password protection and OpenPGP encryption.....	413
Chapter 11, Getting Started with Macros.....	417
Introduction.....	418
Your first macros.....	418
Creating a macro.....	426
Limitations of the macro recorder.....	430
Macro organization.....	431
How to run a macro.....	435
Using extensions.....	437
Writing macros without the recorder.....	437
The ScriptForge library.....	439
UNO Object Inspector.....	440
Overview of Python, BeanShell, and JavaScript macros.....	442
Changing the color scheme of the Basic IDE.....	446
Finding more information.....	447
Chapter 12, Configuring LibreOffice.....	449
Introduction.....	450
LibreOffice options.....	450
Loading and saving documents.....	466
Languages and Locales.....	472
Chart color options.....	482
Internet options.....	483
AutoCorrect functions.....	483
Chapter 13, Customizing LibreOffice.....	485
Introduction.....	486
Menu customization.....	486
Toolbar customization.....	490
Keyboard shortcuts.....	493
Assigning macros.....	496
Adding extensions.....	496
Creating custom colors.....	498
Adding fonts.....	501
User interface variants.....	501
Appendix A, Keyboard Shortcuts.....	503
Introduction.....	504
LibreOffice assistive tools.....	505
macOS keyboard shortcuts.....	505
Keyboard shortcuts.....	506
Sidebar keyboard shortcuts.....	511
Database table keyboard shortcuts.....	512
Controlling macros.....	513
Entering Unicode numbers.....	513
Defining keyboard shortcuts.....	513
Further reading.....	513
Appendix B, Open Source, Open Standards, OpenDocument.....	515
Introduction.....	516
A short history of LibreOffice.....	516
The LibreOffice community.....	516

How is LibreOffice licensed?.....	517
What is open source?.....	517
What are open standards?.....	517
What is OpenDocument?.....	518



LibreOffice
Community



Preface

Who is this user guide for?

Anyone who wants to quickly acquire knowledge on LibreOffice and is new to office software, or may be familiar with another office suite, will find this Getting Started Guide very useful.

LibreOffice is an open-source office productivity software suite containing capabilities for word processing, spreadsheets, presentations, graphics, databases, and formula editing.

What is in this user guide?

This user guide introduces the main modules of LibreOffice.

- Writer (word processing)
- Calc (spreadsheets)
- Impress (presentations)
- Draw (vector graphics)
- Base (database)
- Math (equation editor)

It also covers some of the features common to all modules, including setup and customization, styles and templates, macro recording, and printing. For more detail, see the user guides for the individual modules.

What is LibreOffice?

LibreOffice is a freely available, fully-featured, open source office productivity suite that is compatible with other major office suites and is available on a variety of platforms. The native file format used is Open Document Format (ODF). However, LibreOffice can also open and save documents in many other formats, including those used by several versions of Microsoft Office. For more information, see Appendix B, Open Source, Open Standards, OpenDocument.

Writer (word processor)

Writer is a feature-rich tool for creating letters, books, reports, newsletters, brochures, and other documents. Graphics and objects from other LibreOffice modules can be inserted into Writer documents. Writer can export files to HTML, XHTML, XML, Portable Document Format (PDF), and EPUB. Also, Writer can save files in many other formats, including several versions of Microsoft Word files and connect to the email application being used.

Calc (spreadsheet)

Calc has all of the advanced analysis, charting, and decision making features expected from a high-end spreadsheet. It includes over 500 functions for financial, statistical, and mathematical operations, among others. The Scenario Manager provides “what if” analysis. Calc generates 2D and 3D charts, which can be integrated into other LibreOffice documents. Also, Microsoft Excel workbooks can be opened and worked on, then saved in Excel format. Calc can also export spreadsheets in several formats, including, for example, Comma Separated Value (CSV), Adobe PDF and HTML formats.

Impress (presentations)

Impress provides all the common multimedia presentation tools, such as special effects, animation, and drawing tools. It is integrated with the advanced graphics capabilities of

LibreOffice Draw and Math modules. Slideshows can be further enhanced using Fontwork special effects text, as well as sound and video clips. Impress can open, edit, and save Microsoft PowerPoint presentations and save presentations in numerous graphics formats.

Draw (vector graphics)

Draw is a vector drawing tool that can produce everything from simple diagrams, flowcharts, or 3D artwork. Its Smart Connectors feature allows definition connection points. Draw creates drawings for use in any of the LibreOffice modules, and clip art can be created and added to the Gallery. Draw can import graphics from many common formats and save them in many formats, including PNG, GIF, JPEG, BMP, TIFF, SVG, HTML, PDF and WebP.

Base (database)

Base provides tools for day-to-day database work within a simple interface. Base can create and edit forms, reports, queries, tables, views, and relations, so that managing a relational database is much the same as in other popular database applications. Base provides many new features, such as the ability to analyze and edit relationships from a diagram view. Base incorporates two relational database engines, HSQLDB and Firebird. It can also use PostgreSQL, dBASE, Microsoft Access, MySQL, Oracle, or any ODBC compliant or JDBC compliant database. Base also provides support for a subset of ANSI-92 SQL.

Math (formula editor)

Math is a formula, or equation editor. Math can create complex equations that include symbols or characters not available in standard font sets. While Math is most commonly used to create formulas in other documents, such as Writer and Impress files, Math can also work as a standalone tool. Formulas can be saved in the standard Mathematical Markup Language (MathML) format for inclusion in web pages and other documents not created with LibreOffice.

Advantages of LibreOffice

The following explains some of the advantages of LibreOffice has over other office suites:

No licensing fees

LibreOffice is free for anyone to use and distribute at no cost. Many features that are available as extra cost add-ins in other office suites (like PDF export) are free with LibreOffice. There are no hidden charges now or in the future.

Open source

Distribute, copy, and modify the software as required, in accordance with the LibreOffice Open Source licenses.

Cross-platform

LibreOffice runs on several hardware architectures and under multiple operating systems, such as Microsoft Windows, macOS, and Linux.

Extensive language support

The LibreOffice user interface, including spelling, hyphenation, and thesaurus dictionaries, is available in over 100 languages and dialects. LibreOffice also provides support for both Complex Text Layout (CTL) and Right to Left (RTL) layout languages (such as Urdu, Hebrew, and Arabic).

Consistent user interface

All the modules have a similar “look and feel”, making them easy to use and master.

Integration

The individual modules of LibreOffice are well integrated with the other LibreOffice modules.

All modules share a common spelling checker and other tools, which are used consistently across the suite. For example, the drawing tools available in Writer are also found in Calc with similar, but enhanced versions in Impress and Draw.

There is no need to know which application was used to create a particular file. For example, open a Draw file from Writer and this will open Draw automatically.

Granularity

Usually, if you change an option, it affects all modules. However, LibreOffice options can be set at a module level or even at document level.

File compatibility

In addition to its native Open Document Formats, LibreOffice includes support for opening and saving files in many common formats including Microsoft Office, HTML, XML, WordPerfect, Lotus 1-2-3, and PDF. See Appendix B for a list.

No vendor lock-in

LibreOffice uses OpenDocument, an XML (eXtensible Markup Language) file format developed as an industry standard by OASIS (Organization for the Advancement of Structured Information Standards). These files can easily be unzipped and read by any text editor, and their framework is open and published.

All LibreOffice users have a voice

Enhancements, software fixes, and release dates are community-driven. Join the community and affect the course of LibreOffice.

Read more about LibreOffice and The Document Foundation on their websites at <https://www.libreoffice.org/> and <https://www.documentfoundation.org/>.

Minimum requirements for using LibreOffice

LibreOffice requires one of the following operating systems:

- Linux x64 (deb) and Linux x64 (rpm). Snap, Flatpak, Appimage and other packages are available as well from your distribution channel.
- Mac OS X (Aarch64/Apple Silicon)
- macOS x86_64 (10.14 (Mojave or higher)
- Windows x86_64 (Windows 8 or newer required)

For a detailed list of requirements and operating systems supported, see the LibreOffice website, <https://www.libreoffice.org/get-help/system-requirements/>.

Java software

Some LibreOffice features (wizards and the HSQLDB database engine) require that the Java Runtime Environment (JRE) or, for macOS, the Java Development Kit (JDK) is installed on a computer. If Java is not going to be used, nearly all of the LibreOffice features can still be used.

Java is available at no cost. More information and download links to the appropriate edition for your operating system can be found at: <https://java.com/en/download/manual.jsp>.

For macOS, the Oracle Java Development Kit (JDK) has to be installed, not just the Java Runtime Environment (JRE). Download links can be found at: <https://www.oracle.com/java/technologies/downloads/>.

If LibreOffice features that require Java are to be used, it is important that the correct 32-bit or 64-bit edition matches the installed version of LibreOffice. See the Advanced Options in Chapter 12, Configuring LibreOffice.

How to get LibreOffice

Versions of LibreOffice for Windows, Linux, and macOS are freely available and can be downloaded from <https://www.libreoffice.org/download>. Linux users will also find LibreOffice included free in many of the latest distributions.

Other versions of LibreOffice are listed on the download page such as Portable, an app in the Microsoft Store and Apple Mac App Store at low and affordable prices. The profits from the sales of LibreOffice are invested in supporting the development of the LibreOffice project.

Installing LibreOffice

Information on installing LibreOffice on the various supported operating systems can be found at this web page: <https://www.libreoffice.org/get-help/install-howto/>. When LibreOffice is acquired through official app stores, follow the installation instructions provided by the store.

Setting up and customizing LibreOffice

After installation, to change the default settings (options) in LibreOffice to suit working requirements and preferences, go to **Tools > Options** on the Menu bar (**LibreOffice > Preferences** in macOS). For more information, see Chapter 12, Configuring LibreOffice.

Tip

Some settings are intended for power users and programmers. If it is difficult to understand what an option does, LibreOffice recommends leaving the option on its default setting unless instructions in this user guide recommend changing the setting.

Extensions

More functionalities can be added to LibreOffice by means of extensions. Several extensions have been integrated into the software, along with additional extensions obtained from the official extensions repository, <https://extensions.libreoffice.org/> or from other sources. See Chapter 13, Customizing LibreOffice, for more information on installing extensions.

Where to get more help

This user guide, the LibreOffice module user guides, Help system, and user support systems assume that users are familiar with computers and basic functions such as starting a program, opening and saving files.

Help system

LibreOffice comes with an extensive Help system and this can be used as the first line of support. Windows and Linux users can choose to download and install the offline Help for use when not connected to the Internet. Offline Help is installed with the MacOS version of LibreOffice by default.

To display LibreOffice Help, press *F1* or go to **Help > LibreOffice Help** on the Menu bar. If the offline help is not installed on a computer, but connected to the Internet, a dialog opens giving the option to **Read Help Online**. Select this option and the default web browser opens at the LibreOffice online help pages in the LibreOffice website.

The Help menu also includes links to other LibreOffice information and support resources. The options marked by a † sign in the list below are only accessible if the computer is connected to the Internet.

What's This?

For quick tips when a toolbar is visible, place the cursor over any of the tool icons to see a small tooltip box with a brief explanation of the tool function. For a more detailed explanation, select **Help > What's This?** Also **Extended Tips** can be activated by going to **Tools > Options > LibreOffice > General** (macOS **LibreOffice > Preferences > LibreOffice > General**) on the Menu bar. **Extended Tips** provide a brief description about tools and commands.

User Guides

Opens the default browser at the Documentation page of the LibreOffice website <https://documentation.libreoffice.org/en/english-documentation/>. You can also open the page <https://books.libreoffice.org> for the same contents. These pages give access to the LibreOffice User Guides and other useful information that can be opened in the default browser. Also, the User Guides are available in PDF format as a free download or to buy as printed copies.

Show Tip of the Day

Opens a small window with a random tip on how to use LibreOffice.

Search Commands

Opens a window where typing a few letters, or the name of a Menu bar command, for example, quickly finds where the command is located. Clicking on a command in the resulting list may open a relevant dialog or have other effects.

Get Help Online

Opens the default browser at the Ask LibreOffice forum of questions and answers from the LibreOffice community, <https://ask.libreoffice.org>. Before writing a new question on the Ask website, search for the same content as your question may have already been asked and answered.

Send Feedback

Opens the default browser at the Feedback page of the LibreOffice website <https://www.libreoffice.org/get-help/feedback/>. From this page, bugs can be reported, new features suggested and communicated with other users in the LibreOffice community.

Restart in Safe Mode

Opens a dialog window giving options to restart LibreOffice and performs several diagnostics in an eventual misbehavior of your installation. You can also reset the software to its default settings. Restarting in safe mode also provides an opportunity to restore LibreOffice from a backup.

Get Involved

Opens the default browser at the Get Involved page of the LibreOffice website, <https://www.libreoffice.org/community/get-involved/>. Choose a topic of interest to help improve the program.

Donate to LibreOffice

Opens the default browser at the Donation page of the LibreOffice website, <https://donate.libreoffice.org/> providing an opportunity to make a donation to support LibreOffice.

License Information

Outlines the licenses under which LibreOffice is made available.

Check for Updates

Opens a dialog and checks the LibreOffice website for updates to the software version. The dialog provides an opportunity to download and install any updates to LibreOffice.

About LibreOffice

Opens a dialog and displays information about the LibreOffice version and operating system being used. This information is often requested if the community is asked for help or assistance with the software (on macOS, this option is found under **LibreOffice** on the Menu bar).

Other free online support

The LibreOffice community not only develops software, but provides free, volunteer-based support. See Table 1 and the web page <https://www.libreoffice.org/get-help/>. For comprehensive online support from the community, look at mailing lists and the Ask LibreOffice website, <https://ask.libreoffice.org/en/questions/>. Other user websites also offer free tips and tutorials.

Table 1: Free support for LibreOffice users

FAQs	Answers to frequently asked questions https://wiki.documentfoundation.org/Faq
Mailing lists	Free community support is provided by a network of experienced users https://www.libreoffice.org/get-help/mailling-lists/
Community Forums	Free community discussions on general topics on LibreOffice and its community activities. https://community.documentfoundation.org/
Questions & Answers and Knowledge Base	Free community assistance is provided in a Question & Answer formatted web service. Search similar topics or open a new one in https://ask.libreoffice.org/ The service is available in several other languages; just select your language on the page.
Native language support	The LibreOffice website in various languages https://www.libreoffice.org/community/nlc/ Mailing lists for native languages https://wiki.documentfoundation.org/Local_Mailing_Lists Information about social networking https://wiki.documentfoundation.org/Website/Web_Sites_services
Accessibility options	Information about available accessibility options. https://www.libreoffice.org/get-help/accessibility/
OpenOffice Forum	Another forum that provides support for LibreOffice, among other open source office suites. https://forum.openoffice.org/en/forum/

Paid support and training

Support and training is available through service contracts from a vendor or consulting firm specializing in LibreOffice. For information about certified professional support, see The Document Foundation website: <https://www.documentfoundation.org/gethelp/support/>.

For schools, educational and research institutions, and large organizations, see <https://www.libreoffice.org/download/libreoffice-in-business/>.

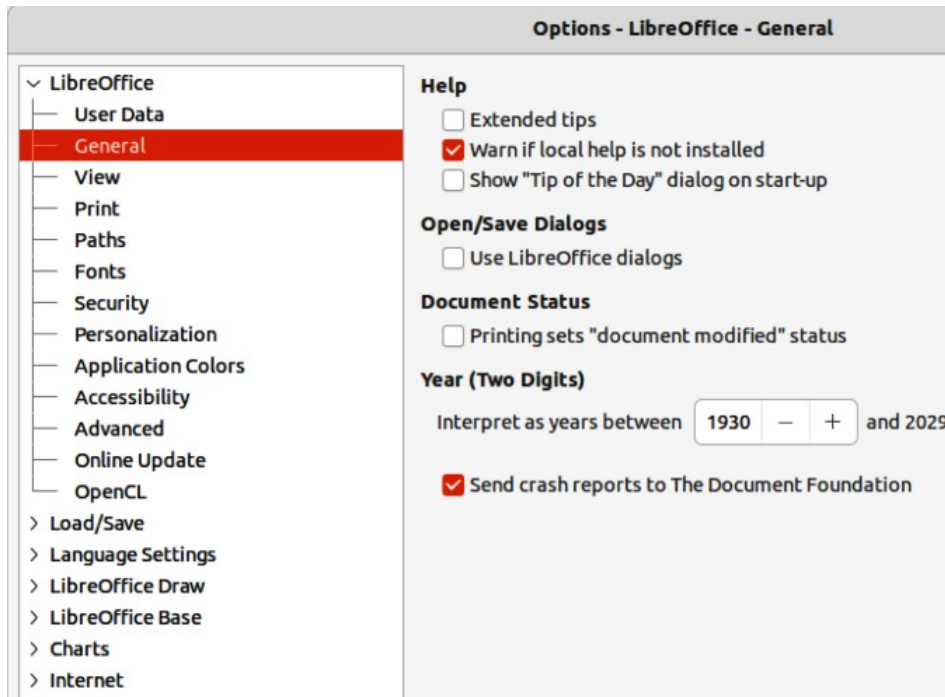

Figure 1: Options LibreOffice General dialog

What you see may be different

Illustrations

LibreOffice runs on the Windows, Linux, and macOS operating systems, each of which has several versions and can be customized by users (fonts, colors, themes, window managers). The illustrations in this guide were taken from a variety of computers and operating systems. Therefore, some illustrations will not look exactly like what is seen on a computer display.

Also, some of the dialogs may differ because of the settings selected in LibreOffice. Either use dialogs from the computer system (default), or dialogs provided by LibreOffice.

To change to using LibreOffice dialogs:

- 1) On Linux and Windows operating systems, go to **Tools > Options > LibreOffice > General** on the Menu bar to open the dialog for general options.
- 2) On a Mac operating system, go to **LibreOffice > Preferences > LibreOffice > General** on the Menu bar to open the dialog for general options.
- 3) Select *Use LibreOffice* dialogs in **Open/Save dialogs** to display the LibreOffice dialogs on a computer display, as shown in Figure 1.
- 4) Click **OK** to save the settings and close the dialog.

Icons

The LibreOffice community has created icons for several icon sets, including Breeze, Colibre, Elementary, and Sifr. Each user can also select a preferred set of fonts to use. The icons used to illustrate some of the many tools available in LibreOffice may differ from the ones used in this guide. The icons in this user guide have been taken from a LibreOffice installation that has been set to display the Colibre set of icons.

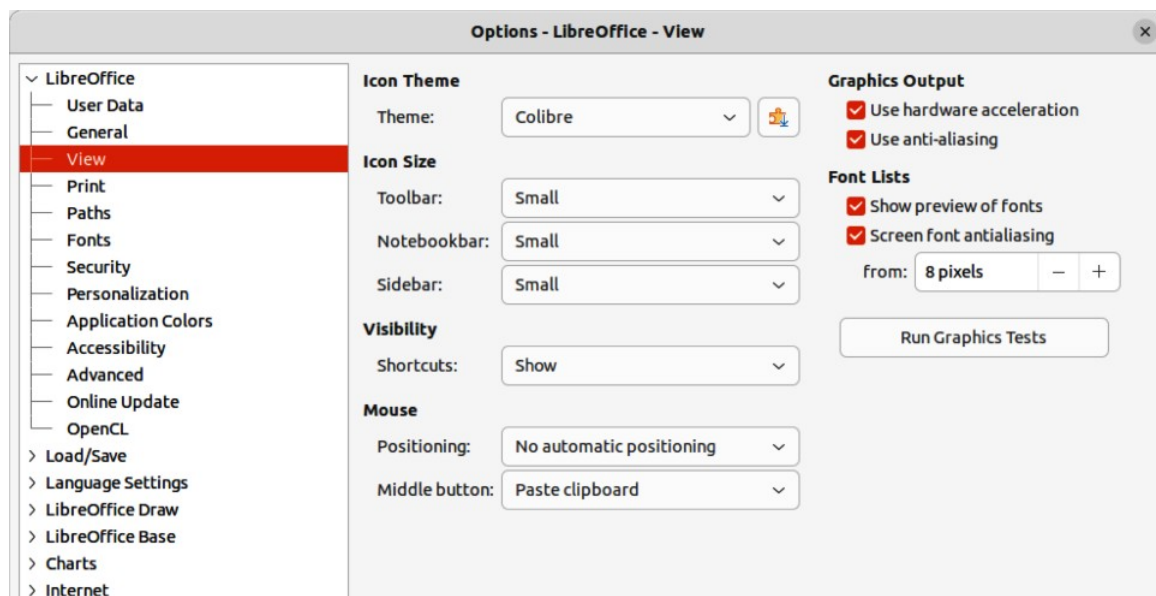

Figure 2: Options LibreOffice View dialog

Change the icon set used in a LibreOffice installation as follows:

- 1) On the Linux and Windows operating systems, go to **Tools > Options > LibreOffice > View** on the Menu bar to open the dialog for view options.
- 2) On a Mac operating system, go to **LibreOffice > Preferences > LibreOffice > View** on the Menu bar to open the dialog for view options.
- 3) In **Icon Style**, select a font from the options available in the drop-down list as shown in Figure 2.
- 4) In **Icon Size**, select the required size from the drop-down lists for *Toolbar*, *Notebookbar* and *Sidebar*, as shown in Figure 2.
- 5) Click **OK** to save the settings and close the dialog.

Notes

Some Linux operating systems, for example Ubuntu, include LibreOffice as part of the installation and may not include the required icon set. This icon set can be downloaded from the software repository for the Linux operating system being used.



Some of the previously included icon sets are now available only as extensions; see <https://extensions.libreoffice.org/?Tags%5B%5D=49> or search for specific ones. For example, the People Gallery is available from <https://extensions.libreoffice.org/en/extensions/show/people-gallery>

Using LibreOffice on macOS

LibreOffice requires macOS 10.15 or newer to run.

Some keystrokes and menu items are different on macOS from those used in Windows and Linux. Table 2 below gives some common substitutions for the instructions in this user guide. For a more detailed list, see the application help.

Table 2: Example of macOS keyboard shortcuts

Windows or Linux	macOS equivalent	Effect
Tools > Options on Menu bar	LibreOffice > Preferences on Menu bar	Access to setup options
Right-click	<i>Ctrl</i> +click and/or right-click depending on computer setup	Opens a context menu
<i>Ctrl</i> or <i>Control</i>	 and/or <i>Cmd</i> or <i>Command</i> , depending on keyboard	Used with other keys
<i>Alt</i>	 and/or <i>Alt</i> or <i>Option</i> depending on keyboard	Used with other keys

What are all these things called?

The terms used in LibreOffice for most parts of the user interface (the parts of the program seen and used, in contrast to the behind-the-scenes code that actually makes it work) are the same as for most other programs.

A dialog is a special type of window. Its purpose is to inform, or request input, or both. The technical names for common controls are shown in Figure 3. In most cases, these technical terms are not used in this user guide, but are useful to know because the Help and other sources of information often use these terms.

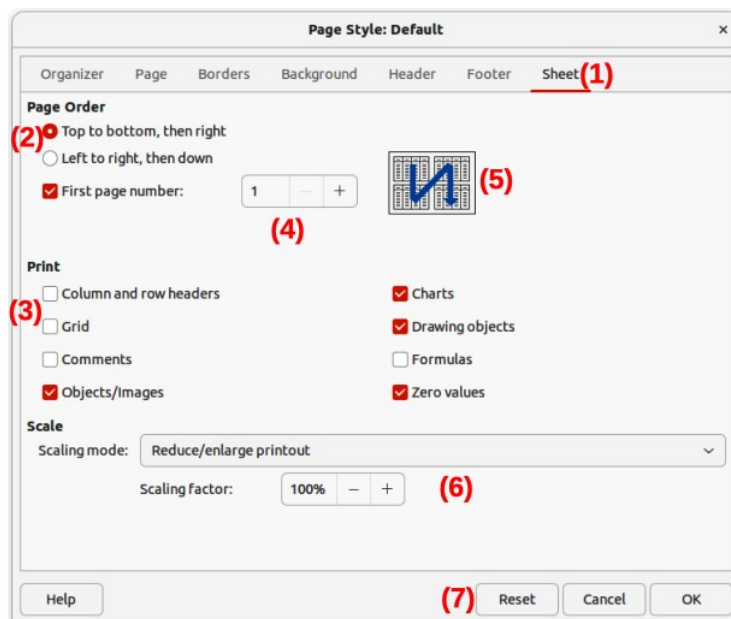

Figure 3: Dialog showing an example of common controls

- (1) Tabbed page (not strictly speaking a control).
- (2) Radio buttons (only one can be selected at a time)
- (3) Checkbox (more than one can be selected at a time)
- (4) Spin box (click the up and down arrows to change the number shown in the adjacent text box, or type in the text box).
- (5) Thumbnail or preview.
- (6) Drop-down list from which to select an item.
- (7) Push buttons.

In most cases, you can interact only with the dialog (not the document itself) as long as the dialog remains open. When you close the dialog after use (usually, clicking OK or another button saves your changes and closes the dialog), then you can again work with the document.

Some dialogs can be left open as you work, so you can switch back and forth between the dialog and the document. An example of this type is the Find & Replace dialog.

Who wrote this user guide?

This user guide was written by volunteers from the LibreOffice community. Profits from sales of the printed edition will be used to benefit the community.

Frequently asked questions

How is LibreOffice licensed?

LibreOffice is distributed under the Open Source Initiative (OSI) approved Mozilla Public License (MPL). See <https://www.libreoffice.org/about-us/licenses/>.

It is based on code from Apache OpenOffice made available under the Apache License 2.0 but also includes software that differs from version to version under a variety of other Open Source licenses. New code is available under LGPL 3.0 and MPL 2.0.

Can LibreOffice be distributed to anyone?

Yes.

Can LibreOffice be sold?

Yes.

Can LibreOffice be used in a business?

Yes.

How many computers can LibreOffice be installed on?

As many as you like.

Is LibreOffice available in different languages?

LibreOffice has been translated (localized for more than 80%, both UI and Help) into over 46 languages, so the language required is probably supported. Localization is well under way for another 30+ languages (50-80%) and for another 50+ languages help is more than welcome. In addition, over 70 spelling, hyphenation, and thesaurus dictionaries are available for languages and dialects that do not have a localized program interface. The dictionaries are available from the LibreOffice extensions website at: <https://extensions.libreoffice.org/>.

Are there templates for presentations, spreadsheets, text documents and drawings?

In addition to the bundled templates that comes with your installation, many templates are available for download in the LibreOffice templates website at <https://templates.libreoffice.org/>.

How can LibreOffice be freely available?

LibreOffice is developed and maintained by volunteers and has the backing of several organizations. LibreOffice also relies upon donations from its users. To make a donation, go to the following web page: <https://www.libreoffice.org/donate/>.

Can the programming code from LibreOffice be used when developing a software application?

Yes, but follow the parameters set in the MPL and/or LGPL. Read the licenses: <https://www.mozilla.org/MPL/2.0/>.

Why is Java required to run LibreOffice? Is it written in Java?

LibreOffice is not written in Java; it is written in the C++ language. Java is one of several languages that can be used to extend the software. The Java JDK/JRE is only required for some features. The most notable one is the HSQLDB relational database engine.

Java is available at no cost. More information and download links to the appropriate edition for an operating system can be found at:

<https://java.com/en/download/manual.jsp>



Note

If the LibreOffice features that require Java are to be used, it is important that the correct 32-bit or 64-bit edition matches the installed version of LibreOffice. If Java is not to be used, nearly all of the LibreOffice features can still be used.

How can users contribute to LibreOffice?

Users can help with the development and user support of LibreOffice in many ways, and there is no need to be a programmer. To start, check out this web page:

<https://www.libreoffice.org/community/get-involved/>. An interactive web page that guides users in contributing with their best skills available at <https://whatcanidoforlibreoffice.org>.

Can the PDF copy of this user guide be distributed, or printed and copies sold?

Yes, as long as requirements are met for one of the licenses in the copyright statement at the beginning of this user guide. There is no need to request special permission.

LibreOffice requests that users share with the LibreOffice project some of the profits made from sales of user guides, in consideration of all the work that LibreOffice volunteers have put into producing user guides.

What is new in LibreOffice ?

The LibreOffice Release Notes are available at these links <https://wiki.documentfoundation.org/ReleaseNotes/24.2> and <https://wiki.documentfoundation.org/ReleaseNotes/24.8>

Also at this link, the release notes for earlier versions of LibreOffice are located giving more information on the features that are included in LibreOffice.

Noticeable improvements or enhancements to this version include the following:

- New "Quick find" deck in the Sidebar
- Impress: Notes pane under the slide
- Draw: hover a layer's tab to show its objects
- New chart types: "Pie-of-pie" and "Bar-of-pie"
- New spreadsheet functions: XLOOKUP, XMATCH, FILTER, RANDARRAY, SEQUENCE, SORT, SORTBY, UNIQUE, LET
- Disable hyphenation for selected words
- Search for objects in Gallery Sidebar deck
- New Color Scheme dialog in Basic IDE



LibreOffice
Community



Chapter 1, LibreOffice Basics

Getting Started

Installation

The process for installing LibreOffice varies by operating system. Table shows the effect of installation on each supported operating system.

Table 3: Results after installation in supported systems

Operating System	Installation Effect
Windows	A desktop icon is created
Linux	Entries for LibreOffice and each of the LibreOffice modules appear in Applications.
macOS	An entry for LibreOffice is added to Applications.

Start-Up

Using the desktop icon or clicking on **LibreOffice** in your Applications folder launches the LibreOffice Start Center where recent files are shown along with the available modules.

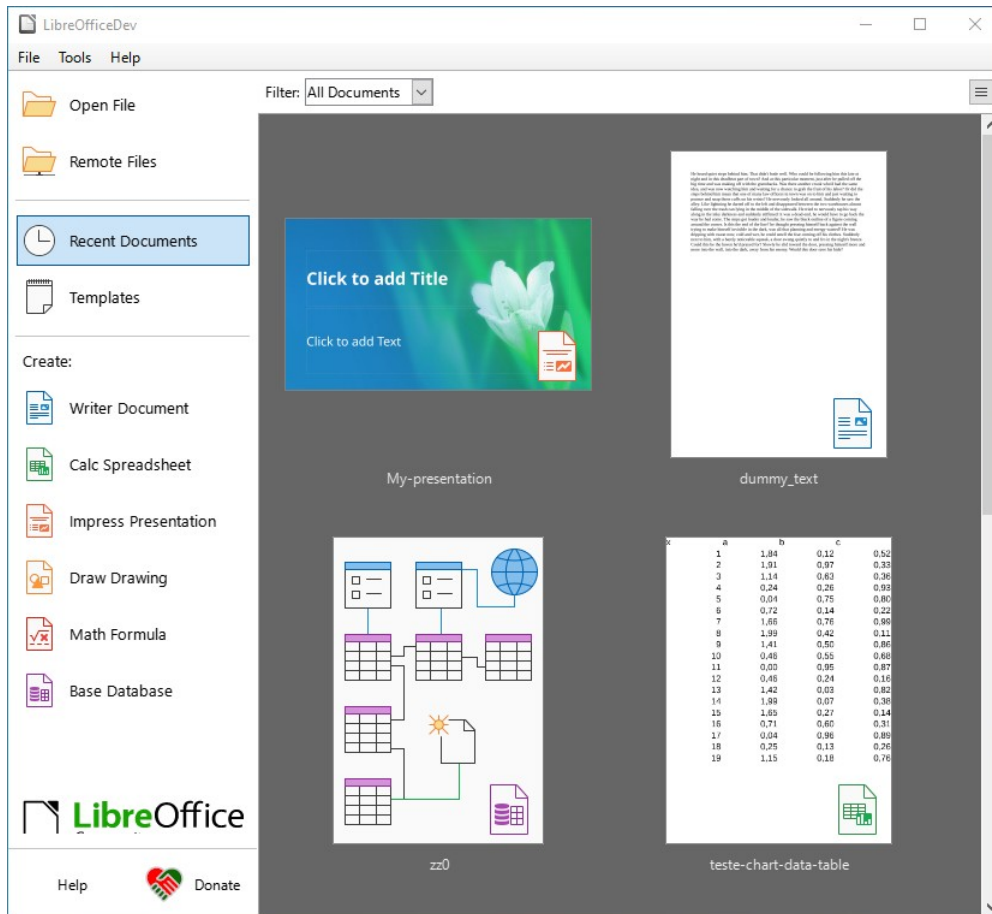

Figure 4: LibreOffice Start Center

To reduce the number of files displayed in the Start Center, select a LibreOffice module from the **Filter** drop-down list. Only files that can be opened by the selected LibreOffice module are displayed in the Start Center.

 **TIP**

To pin a document in the Start Center so it can be always visible, hover over the corresponding document and click on the pin icon in the top left corner. The selected document will then be shown in a separate line at the beginning of the list, along with other pinned documents.

Module Use

LibreOffice modules can be opened by:

- Clicking on the name of a LibreOffice module.
- Clicking on a file that is displayed in the Start Center, which will activate the module associated with that file.
- Selecting **Templates** in the Start Center and choosing a template for a new file, which will open the LibreOffice module associated with that template.
- Selecting **Open File**, which will allow you to navigate to the chosen file's location, select it, then click on the **Open button** to open the file and the applicable LibreOffice module.
- Selecting **Remote File**, which will open the Remote Files file browser. Here, you can navigate to the file location, select it, then click on the **Open button** to launch the applicable LibreOffice module.

 **Note**

A LibreOffice module will become active if you double-click the filename of an ODF document in a folder, or file browser. The document opens in the appropriate LibreOffice module. For more information on opening files, see “Opening existing documents” on page 35.

Closing LibreOffice

There are multiple methods for closing LibreOffice:

Windows and Linux

- Go to **File > Exit LibreOffice** on the Menu bar.
- Use the keyboard shortcut *Ctrl+Q*.
- If only one LibreOffice document is open, click on the X on the right of the title bar to close the entire application.

macOS

- Go to **LibreOffice > Quit LibreOffice** on the Menu bar.
- Use the keyboard shortcut **⌘+Q**

 **Note**

If any documents have not been saved since the last change, a warning message is displayed. Select whether to save or discard the changes.

Main LibreOffice window

Each LibreOffice module's user interface is based on the main LibreOffice window. Each module has various details depending on the module's functions.

Every module has the Title bar, Menu bar, and Standard toolbar at the top of the window and the Status bar at the bottom of the window, while the tools and information vary between each LibreOffice module.

Note

By default, LibreOffice commands are grouped in the Standard Toolbar user interface. Other user interface variants are available. Go to **View > User Interface** on the Menu bar to change the user interface. For more information, see Chapter 13, Customizing LibreOffice.

Title bar

The Title bar is located at the top of the LibreOffice window and it shows the file name of the current document. When a document is created the document name will be Untitled X, where X is a number. New documents are numbered in the order in which they are created.

Menu bar

The Menu bar is located above the Standard toolbar in Windows and Linux operating systems and at the top of the desktop in macOS. When selecting one of the menus in the Menu bar, a specific submenu will appear. They feature commands that can do one of these commands:

- Directly cause an action, for example **File > Close** or **Save**.
- Open a dialog. Any command that opens a dialog has three dots following that command, for example: the command **Edit > Find and Replace...** on the Menu bar will open a dialog.
- Open another submenu. Any command that opens yet another submenu has a right-pointing chevron > that follows the command's name. Moving the mouse's arrow over one of these commands opens another submenu that contains additional commands, for example **View > Rulers > Rulers**, or **Vertical Ruler**.
- Contains keyboard shortcuts for some commands.
- May contain the icon for the command.
- May contain a selection box or radio button box indicating a selection.

For example, the default Menu bar for the LibreOffice Writer module includes the controls described in Table 4.

Table 4: Menu bar entries

Control	Description
File	Lists commands that apply to the entire document, for example Open , Save , and Print .
Edit	Has commands for editing a document, including Undo , Find and Replace , Cut , Copy , Paste , and Track Changes .
View	Lists commands that control how a document is displayed, such as User Interface , Toolbars , Text Boundaries , Rulers , and Zoom .
Insert	Has commands that insert elements into a document, for example Image , Comment , Header and Footer , and Table of Contents and Index .
Format	Lists commands that are used to format a document's layout.

Control	Description
Styles	Has commands that handle type styles. It includes commands that apply common styles and manage styles as well as commands for editing, loading, and creating styles.
Table	Lists commands that allow you to insert and edit tables with text.
Form	Has commands that create fill-in forms.
Tools	Lists Writer functions that handle specific tasks, including Spelling , AutoCorrect , Customize , and Options .
Window	Has commands that affect the display window.
Help	Links to the LibreOffice Help, What's This?, and information about LibreOffice.

Note

Table 4 shows the default Menu bar controls for the Writer module. The default controls for other modules may vary.

Toolbars

LibreOffice's toolbars can be in one of two states: docked and floating. A docked toolbar is attached to the document's main window, while floating toolbars are independent of the main window and can be moved anywhere on your screen.

In the default LibreOffice installation, the Standard toolbar is docked at the top of the window across all of the LibreOffice modules and the second toolbar is in a docked to the top of the window. The second toolbar changes depending on which LibreOffice module is open. For example, if Writer or Calc are opened, the second docked toolbar is the Formatting toolbar.

Usually, the module's second toolbar is context-sensitive and usually its set of tools change depending on which object is selected. So when a graphic object is selected in Writer, the Drawing Object Properties toolbar, which provides tools for formatting graphics, replaces the Formatting toolbar. When you deselect the graphic object, the Drawing Object Properties toolbar closes and the Formatting toolbar reopens.

Note

When it is necessary to reduce the number of toolbars displayed and provide more space for a document, the user interface can be changed to a single-toolbar as an alternative to the default double-toolbar user interface.

This single-toolbar user interface contains the most-used commands. To activate a single toolbar user interface, go to **View > User Interface** and select **Single Toolbar** from the Select Your Preferred User Interface dialog. For more information, see Chapter 13, Customizing LibreOffice.

Displaying or closing toolbars

To display a toolbar, go to **View > Toolbars** on the Menu bar, and select the name of a toolbar from the submenu. All active toolbars have a check-mark next to their name.

To close a toolbar, you can either:

- Go to **View > Toolbars** on the Menu bar and deselect the toolbar, or
- Right-click in an empty space between the icons on a toolbar and select **Close Toolbar** from the context menu.

Note

The View menu does not include floating toolbars that were created from tool palettes, but they are displayed in the LibreOffice window.

Submenus and tool palettes

If a toolbar item has submenus, there will be a small triangle ▼ to the right of the tool's icon. Clicking on the triangle will display submenus containing further commands, tool palettes, or alternative methods of selecting items.

A tool palette is a pop-up collection of tools attached to a single tool on a toolbar. Tool palettes can be made into floating sub-toolbars using the following example:

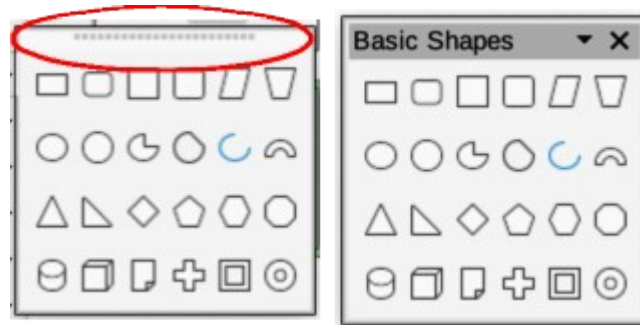

Figure 5: Example of creating floating sub-toolbar from a tool palette

- 1) Click on **Basic Shapes** on the Drawing toolbar to open the tool palette.
- 2) Click on the toolbar handle (highlighted in Figure 5) and drag the tool palette onto the open document.
- 3) Release the toolbar handle and the tool palette becomes a floating toolbar.

Note

If the toolbar handle is not visible, the tool palette, or toolbar, is locked into its docked position and has to be unlocked. See “Locking and unlocking toolbars” below for more information.

Locking and unlocking toolbars

If you want to lock all toolbars into place, which will prevent all toolbars from being moved, select **View > Toolbars** on the Menu bar and select **Lock Toolbars** on the submenu. LibreOffice has to be restarted to lock all toolbars. If the command **Lock Toolbars** has a check mark next to it, all toolbars will be locked.

To unlock all toolbars and allow all toolbars to be repositioned, or turned into floating toolbars, go to **View > Toolbars** on the Menu bar and select **Lock Toolbars** on the submenu. To finish unlocking all toolbars, LibreOffice has to be restarted to complete this task. Once you have finished unlocking the toolbars, the check mark will be removed from the command **Lock Toolbars**.

However, if you single toolbar to prevent it from being repositioned, or turned into a floating toolbar, right-click in an empty space on the toolbar and select **Lock Toolbar Position** from the submenu that opens. A check mark appears against **Lock Toolbar Position**.

To unlock a single toolbar so that it can be repositioned, or used as a floating toolbar, right-click in an empty space on the toolbar and select **Lock Toolbar Position** from the submenu that opens. The check mark next to **Lock Toolbar Position** is removed.

Moving, docking and floating toolbars

If a toolbar is docked and not locked, it will have a toolbar handle at the left end of the toolbar. This dotted toolbar handle is highlighted in Figure 6. This handle is used to control the location of the toolbar.

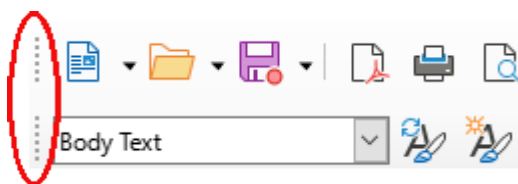

Figure 6: Example of toolbar handles

- 1) Move the cursor over the toolbar handle (the small vertical bar of dots to the left of a docked toolbar). The cursor will change shape to the moving shape used by the computer system.
- 2) Click on the toolbar handle and drag the toolbar to a new docked position, or create a floating toolbar, then release the toolbar. When the toolbar becomes a floating toolbar, the toolbar handle disappears.

To move a floating toolbar, use one of the following methods:

- Click in the toolbar title bar and drag the toolbar to a new floating position in the main window, then drop the toolbar.
- Select the toolbar title bar and drag the toolbar into a location in which it can be docked. You can dock a toolbar at the top, the left side, and the bottom of the main window.
- Select the downward triangle ▼ on the toolbar title bar, then select **Dock Toolbar** from the available options. The toolbar is docked in its default position. For example, the docked position for the Bullets and Numbering toolbar is at the bottom of the main window.

Note

When you are moving a toolbar into a docked location, LibreOffice will indicate that the toolbar is in a docked position when you see a hashed border around the toolbar. Once the hashed border appears, release the toolbar and the toolbar is docked.

Context sensitive toolbars

Some toolbars in LibreOffice are context sensitive and only open when an object is selected, or the cursor has been positioned in text. For example:

- The cursor is positioned in a table and the Table toolbar opens.
- The cursor is positioned in an ordered or unordered list, and the Bullets and Numbering toolbar opens.
- An image is selected and the Image toolbar opens.

Customizing toolbars

To customize a toolbar, you can add tools listed in **Visible Buttons**, or add new tools to a toolbar. Also, you can access the customization options for a toolbar by right-clicking in an empty space on a docked toolbar or clicking on the downward triangle ▼ on the title bar of a floating toolbar to open a context menu:

- To open the Customize dialog and add more tools to the toolbar, select **Customize Toolbar**. If you need more information on customization, see Chapter 13, Customizing LibreOffice.

- To dock the selected floating toolbar in its default position, select **Dock Toolbar**. The toolbar can be moved to a different docked position.
- To dock all floating toolbars in their default positions, select **Dock All Toolbars**. The toolbars can be moved to different docked positions.
- To lock a docked toolbar into its docked position, select **Lock Toolbar Position**.
- To close the selected toolbar, click on the X on the right of the toolbar title bar or select **Close Toolbar**.
- Finally, you can select **Visible Buttons** and select the required tool from the options in the context menu. Tools already installed on a toolbar are indicated by a check mark next to the tool icon. The tools are added to the toolbar in the same order as the tools appear in the context menu. That is, the top tool in the **Visible Buttons** list is positioned at the left end of the toolbar. The remaining tools are positioned on the toolbar in a position that matches its list position.

Context menus

Context menus, which provide quick access to many menu functions, can be opened by right-clicking on a paragraph, graphic, or other object. When a context menu is opened, the available functions or options depend on the object that has been selected. A context menu is the easiest way to use a function or option, especially if its location in the menus or toolbars is not known.

Context menus can also display applicable keyboard shortcuts if one has been created, or tool icons if available. To use these options, go to **Tools > Options > LibreOffice > View** (macOS **LibreOffice > Preferences LibreOffice > View**) and select the options available in **Visibility**.

Status bar

The Status bar is located at the bottom of the workspace. It provides information about the document and also include convenient ways to change some features quickly. It is similar in Writer, Calc, Impress, and Draw, but each LibreOffice module includes some module-specific items. To hide the Status bar, go to **View** on the Menu bar and deselect **Status Bar**.

The Impress Status bar is shown in Figure 7 and it has the following components:

Slide number

The slide number currently displayed in the Impress Workspace and the total number of slides in the presentation.

Information area

Changes depending on the object selected on the current Impress slide. Examples shown in Table 5.

Table 5: Examples of information

Example selection	Examples of information shown
Text area	Text Edit: Paragraph x, Row y, Column z
Charts, spreadsheets	Embedded object (OLE) "ObjectName" selected

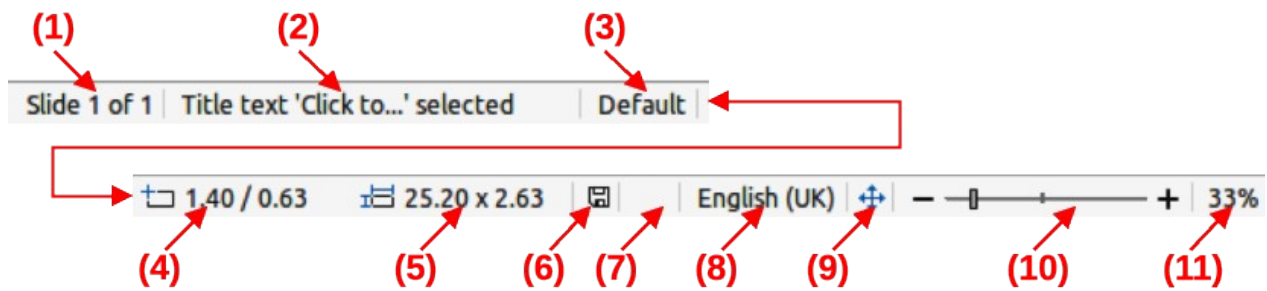

Figure 7: The Impress Status bar

- | | | |
|---------------------|----------------------|---------------------|
| 1) Slide number | 5) Object size | 9) Fit slide |
| 2) Information area | 6) Unsaved changes | 10) Zoom slide |
| 3) Master slide | 7) Digital signature | 11) Zoom percentage |
| 4) Cursor position | 8) Text language | |

Master slide

The master slide associated with the slide or notes pages in the Workspace. You can right-click this area to view a list of available master slides in Impress. If necessary you can select a master slide and apply it to the current slide. Double-click to open the Available Master Slides dialog.

Cursor position/Object size

Shows different information depending on which Impress objects are selected or not:

- When no object is selected, Impress displays the current position (X and Y coordinates) of the cursor.
- When an object is selected and being resized, this area of the Impress Status bar shows the size of the object (width and height).
- If an object is currently selected in Impress, the position numbers shows X and Y coordinates of the upper-left corner and the object size number pair displays the size of the object. These numbers do not relate to the object itself, but to the selection outline, which is the smallest possible rectangle that can contain the visible parts of the object.
- When an object is selected, clicking in these areas opens the Position and Size dialog.

Unsaved changes

Indicates if there are any unsaved changes in the Impress presentation. Clicking on this icon saves the document. If the presentation has not been saved before, the Save As dialog opens giving the opportunity to save the presentation.

Digital signatures

Indicates if the Impress presentation has a digital signature.

Text language

Indicates the language used for any text in an Impress presentation.

Fit slide

When this icon is selected, the displayed slide in the Impress Workspace zooms to fit in the Workspace.

Zoom slider

When this slider is moved, the slide displayed in the Impress Workspace will adjust how the document is viewed (by percentage) in the Workspace.

Zoom percentage

Indicates the zoom level of the slide displayed in the Impress Workspace. Clicking on zoom percentage opens the Zoom & View Layout dialog where the settings for zoom factor and view layout are adjusted.

Sidebar

By default, the Sidebar is on the right side of a LibreOffice module's Workspace. An example of the Writer Sidebar is shown in Figure 8. Go to **View > Sidebar** on the Menu bar to display or hide the Sidebar.

The Sidebar contains several decks and each deck contains tools and options for formatting a document. The number and type of decks used in the Sidebar depend on the type of document and the current LibreOffice module. Decks are organized into panels and an icon bar on the right side of the Sidebar allows switching between the different decks.

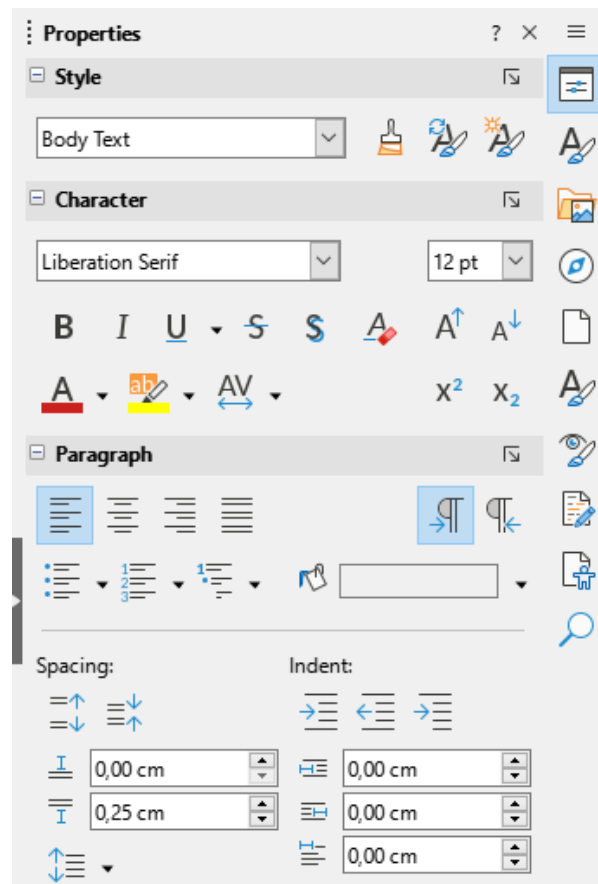

Figure 8: Example of Properties deck in Writer Sidebar

For all LibreOffice modules, each Sidebar contains Properties, Styles, Gallery, and Navigator decks. Some LibreOffice modules also have additional decks:

- Page Style, Design themes, Style Inspector , Manage Track Changes, Accessibility check and, Search Text for Writer
- Master Slides, Animation, Shapes, and Slide Transition for ImpressShapes for Draw
- Functions for Calc

In LibreOffice, menus, toolbars, and Sidebar panels share many functions across modules. For example, text can be made bold or italic with the Format menu, the Formatting toolbar, or the Properties deck. Some Sidebar panels also have a More Options button, which opens a dialog

with additional editing controls. For more detail on options available on the Sidebar, see the guides for each LibreOffice module.

To hide the Sidebar, click on **Hide/Show** button on the left of the Sidebar (highlighted in Figure 8). To show the Sidebar, click on the **Hide/Show** button again.

To undock the Sidebar and make it floating, do the following:

- 1) Click on **Sidebar Settings** at the top right, do the Sidebar.
- 2) Select **Undock** from the options available, or use the keyboard shortcut *Ctrl+Shift+F10* (macOS +*Shift+F10*).

To dock the Sidebar into its usual position on the main window, do the following:

- 1) Click on **Sidebar Settings** at the top right of the Sidebar.
- 2) Select **Dock** from the options available, or use the keyboard shortcut *Ctrl+Shift+F10* (macOS +*Shift+F10*).

Working with documents

New documents

LibreOffice has multiple methods for creating a new document:

- Open the LibreOffice Start Center then click on the name of a LibreOffice module. For example, click on **Impress Presentation** and a new presentation is created.
- Click on **Templates** in the Start Center and the available LibreOffice templates are displayed. Click on the required template to create a new file and the LibreOffice module opens with a new document.
- Go to **File > New** on the Menu bar and select the type of document from the submenu that opens. The applicable LibreOffice module also opens.
- Click on the downward triangle ▼ next to **New** on the Standard toolbar and select the type of document from that context menu. For example, click on **Drawing** and a new drawing is created. The applicable LibreOffice module also opens.
- Click on **New** on the Standard toolbar and a new document is created by the LibreOffice module. For example, if Writer is open and active, this icon will create a new Writer document.
- Use the keyboard shortcut *Ctrl+N* (macOS +*N*) to create a new document. The type of document created depends on which LibreOffice module is open and active. For example, if Calc is open and active, a new spreadsheet is created.
- Go to **File > Wizards** on the Menu bar and select the type of document from the options available in the submenu.

Opening existing documents

To open an existing LibreOffice document in the appropriate module, use one of the following methods.

- Click **Open File** in the Start Center and select the file.
- Go to **File > Open** on the Menu bar and select the file.
- Click on **Open** on the Standard toolbar and select the file.
- Use the keyboard shortcut *Ctrl+O* (macOS +*O*) and select the file.

- Click **Recent Documents** in the Start Center and select a recent file from the Center.
- Go to **File > Recent Documents** on the Menu bar and select the file from the files displayed in the context menu.
- Go to **File > Open Remote** on the menu bar and select the file from the list of files made available by the remote server service. You may be asked to insert the right server credentials to open the file.

Notes

Note that the previous names or locations of files that have been renamed or relocated may still be in the Start Center, and clicking on those types of filenames will generate an error. To remove the file from the Start Center, hover the cursor over the thumbnail until an X appears in the upper right corner, and then click on the X.



When you are selecting a LibreOffice file from the Start Center, Open dialog, or file browser you can limit the files seen by file type. For example, you select **Text Documents** as the file type, only documents that Writer can open are displayed.

If you need to work with files on remote servers, see Chapter 10, Working with File Formats, Security, and Exporting.

Also, LibreOffice can open files compatible with the Open Document Format (ODF), which includes many formats from Microsoft. For example, LibreOffice can open MS Word files (*.doc or *.docx) in Writer, MS Excel files (*.xls or *.xlsx) can be opened in Calc; MS PowerPoint files (*.ppt or *.pptx) can be opened in Impress, and so on. See Chapter 10, Working with File Formats, Security and Exporting for more information about working with different file types.

Saving documents

LibreOffice documents can be saved with one of the following methods:

- **Save** — can save all changes made, keeping the current filename and location of the file.
 - Go to **File > Save** on the Menu bar.
 - Use the keyboard shortcut *Ctrl+S* (macOS +S).
 - Click on **Save** on the Standard toolbar.
 - Click on the **Save** icon in the Status bar.
- **Save As** — can create a new document, change the filename or file format, or save the file in a different location on a computer system.
 - Go to **File > Save As** on the Menu bar.
 - Use the keyboard shortcut *Ctrl+Shift+S* (macOS +Shift+S).
 - Click on the downward triangle ▼ next to **Save** on the Standard toolbar and select **Save As** from the context menu.
- **Save a Copy** — can save a copy of the current document, for example, in a different location on the computer system. The current document remains open for more editing.
 - Go to **File > Save a Copy** on the Menu bar.
 - Click on the downward triangle ▼ next to **Save** on the Standard toolbar and select **Save a Copy** from the context menu.

- **Save All** — can save all the files that are open in LibreOffice. Go to **File > Save All** on the Menu bar. This option is only available when more than one LibreOffice document is open.
- **Save Remote** – save the file in a remote server. The remote server settings must exist prior to the **Save Remote** command. If not, you can define the remote server settings and protocols in the Remote Files dialog. Some servers requires the correct credentials to allow the files to saved.

Saving documents automatically

If you need LibreOffice to save files automatically, you can use the AutoRecovery function. When files are saved automatically, LibreOffice will overwrite the last saved state of the file. To set up automatic file saving, do the following:

- 1) Go to **Tools > Options > Load/Save > General** (macOS **LibreOffice > Preferences > Load/Save > General**) on the Menu bar.
- 2) In **Save**, select the option *AutoRecovery information every* and set the time interval in the box, for example 10 minutes.
- 3) Optionally, you can save the whole file instead by checking the *Automatically save the document too* checkbox. The time interval is the same as the *AutoRecovery information every* time interval.
- 4) Click **OK** to save the selection and close the dialog.

Reloading documents

If you reload a document in LibreOffice, all the changes made in an editing session after the last save are discarded. To reload a document, go to **File > Reload** on the Menu bar.

Note

If you reload a document, a confirmation dialog will open and warn the user that reloading will discards the last unsaved changes.

Closing documents

Close a LibreOffice document with one of the following methods:

- Go to **File > Close** on the Menu bar.
- In Windows or Linux — click on the **X** at the right end of the Menu bar.
- In macOS — click on the red button at the left end of the title bar.

If the document to be closed is the only document that is open, the following happens:

- In Windows or Linux — the document closes and the LibreOffice Start Center opens.
- In macOS — the document closes and the Menu bar remains at the top of the screen.

Note

If the document has not been saved since the last change, a confirmation dialog opens with a warning message. Select whether to save, or discard, the changes before closing.

Using the Navigator

The Navigator is available as a dialog or Sidebar deck, and it lists all objects contained in a document in categories. Examples can be seen in examples from Impress and Writer (Figure 9 and Figure 10). The Navigator can be opened with one of the following methods:

- Navigator dialog: go to **View > Navigator** on the Menu bar, or use the keyboard shortcut *F5* for Windows and macOS, or *Ctrl+Shift+F5* for Linux.
- Navigator deck on the Sidebar: click on the Navigator icon on the right of the Sidebar, or use the keyboard shortcut *Alt+Ctrl+4* for Windows and Linux, or *⌘+⌥+4* for macOS.
- To close the Navigator, click on the **X** on the right of the title bar, or use the keyboard shortcut. The categories are specific to each LibreOffice module. Click on the right chevron **>** next to each category name to open the list of objects contained in each category. Also, the Navigator provides some functions that are specific to each LibreOffice module.

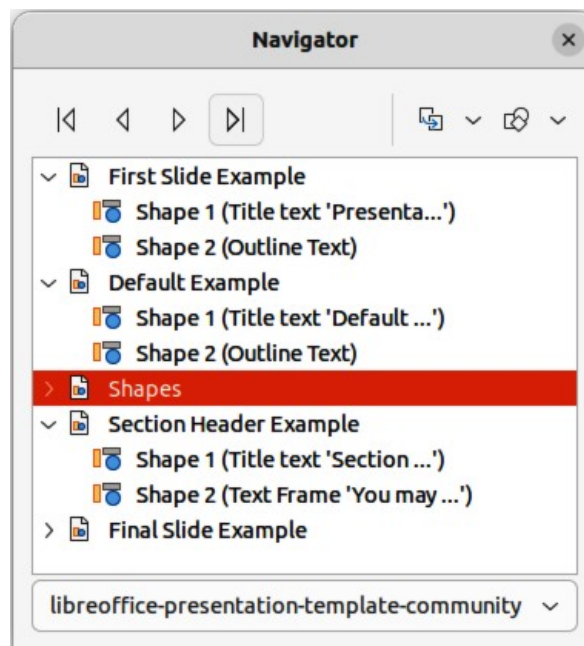

Figure 9: Example of Impress Navigator dialog

The Navigator provides an easy method of locating and selecting objects in a document. If possible you should give each object an easily identified name so you can easily locate an object, instead of using default names such as Sheet1, Table1, or Image2, and so on. Right-click on an object in the Navigator dialog, or Sidebar deck and select **Rename** from the context menu.

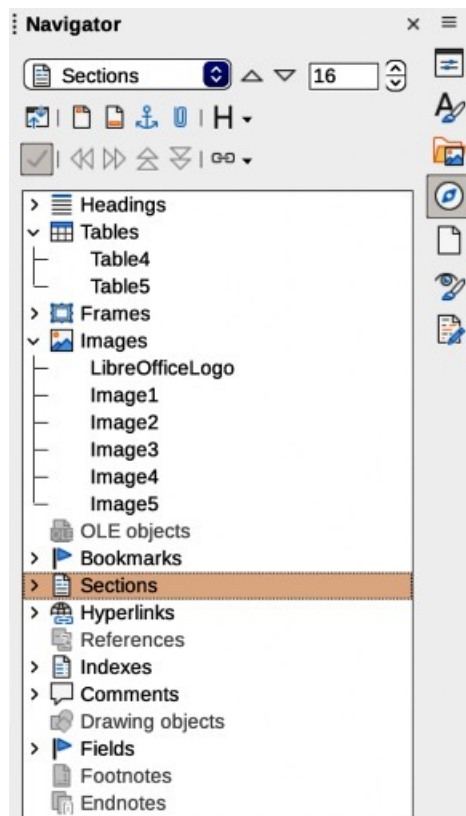

Figure 10: Example of Navigator deck in Writer Sidebar

Displaying multiple views of a document

Users can open multiple views of the same document in LibreOffice. Each view can be displayed in its own window and LibreOffice can show different pages, use different zoom levels, or use other settings. When a user makes a change to the document in one window, it will be reflected in the other windows. For example, when using Writer, separate views of a document can be used for copying or moving information from one page to another.

To open a new document window, go to **Window > New Window** on the Menu bar. In each open window, the filename of the document will be displayed in the title bar. Figure 11 shows how separate views of one document can be open at the same time. If other LibreOffice documents are open at the same time, the LibreOffice windows list also includes these other documents and the active window has a check mark by its filename. You can switch between windows by clicking on a name in the list or by clicking on the window itself if it is visible on the display.

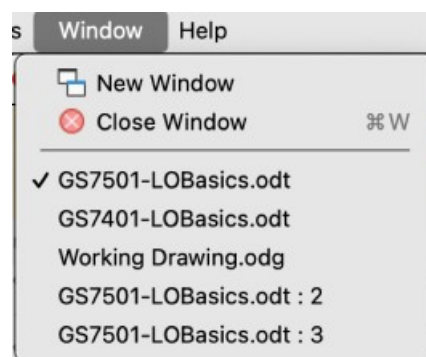



Figure 11: Example of separate windows list

To close a window, go to **Window > Close Window** on the Menu bar, use the keyboard shortcut *Ctrl+W* (macOS *⌘+W*).

Undoing and redoing changes

Undoing

To undo the most recent change in a document, use one of these methods:

- Use the keyboard shortcut *Ctrl+Z* (macOS +Z).
- Click on **Undo** in the Standard toolbar.
- Go to **Edit > Undo** on the Menu bar.
- Click the small triangle ▼ to the right of **Undo** on the Standard toolbar to open a list of changes that can be undone. Multiple consecutive changes can be selected and deleted at the same time.

Redoing

After changes have been undone, changes can be redone using one of the following methods:

- Use the keyboard shortcut *Ctrl+Y* (macOS +Y).
- Click on **Redo** in the Standard toolbar.
- Go to **Edit > Redo** on the Menu bar.
- Click the small triangle ▼ to the right of **Redo** on the Standard toolbar to open a list of undo commands that can be redone. LibreOffice can select multiple consecutive undo commands and redo them at the same time.

Repeating undo and redo commands

Repeating undo and redo commands can save several repetitive menu navigation clicks, or keyboard shortcuts, especially when a command is taken from a context menu or submenu. To repeat the last undo or redo command applied to a document, use one of the following methods:

- Use the keyboard shortcut *Ctrl+Shift+Y* (macOS +Shift+Y).
- Go to **Edit > Repeat** on the Menu bar.

Printing

Default printer

Here are examples of how to setup a default printer on a computer in LibreOffice. The method will vary depending on the computer and its operating system.

Notes

When printing, the name of the default printer installed on a computer appears in the **Print** tool name, **Print Directly** tool name, Print dialog, and Printer Settings dialog.

For more information about printing the different types of documents that LibreOffice can create, see the user guides for each LibreOffice module.

Printing options are not available when viewing a LibreOffice Base table or query.

Windows

- 1) Open **Settings**, then go to **Devices > Printers & scanners**.
- 2) Select a printer from the displayed list.
- 3) Select **Manage > Set as default** and then close **Settings**.

Linux

- 1) Open **Settings**, then go to **Printers**.
- 2) Select a printer from the displayed list.
- 3) Click on the settings icon on the right of the printer name.
- 4) Select **Use Printer by Default** from the drop-down list and close **Settings**.

macOS

- 1) Open **System Settings**, then open **Printers & Scanners**.
- 2) In **Default printer** select the printer to use as default printer from the drop-down list, then close **Settings**.



Figure 12: Draw Standard toolbar with Print Directly installed

Quick printing

LibreOffice can print an entire open document using the computer's default printer. To quick print, click on **Print Directly** on the Standard toolbar.

If **Print Directly** is not visible on the Standard toolbar, it can be installed as follows:

- 1) Right-click in a blank area on the Standard toolbar to open a context menu.
- 2) Select **Visible Buttons** from the context menu.
- 3) Select **Print Directly** from the list of available tools to install it on the Standard toolbar, as shown by the highlighted example in Figure 12.

Printer setup

Table 6 lists the options that are available in the Printer Setup dialog:

Table 6: Options for printer setup

Option	Description
Printer	Lists information that applies to the selected printer. If the list is empty, install a default printer for the computer. Refer to the printer and computer user guides for more information on connecting printers.
Name	Lists the installed printers on the computer. To change the default printer, select a printer name from the drop-down list.
Status	Describes the current status of the selected printer.
Type	Displays the type of printer that is selected.
Location	Displays the computer connection for the selected printer.
Comments	Displays additional information for the printer.
Properties	Changes the printer settings of the computer operating system for the current document. Make sure that the layout orientation (Landscape or Portrait) matches the page format set in Format > Page on the Menu bar.
Options	Opens the Printer Options dialog box allowing the global printer options set in Tools > Options > LibreOffice Writer or LibreOffice Calc > Print (macOS LibreOffice > Preferences > LibreOffice Writer or LibreOffice Calc > Print) to be overridden when printing the current document.

 **Note**

Options in the Printer Settings dialog is only available in LibreOffice Writer and Calc.

Here is an example of setting up a printer on a computer for LibreOffice:

- 1) Connect the printer to the computer. Refer to the printer and computer user guides for more information on connecting printers.
- 2) Go to **File > Printer Settings** on the Menu bar to open a Printer Setup dialog. Figure 13 shows an example of a Printer Setup dialog.

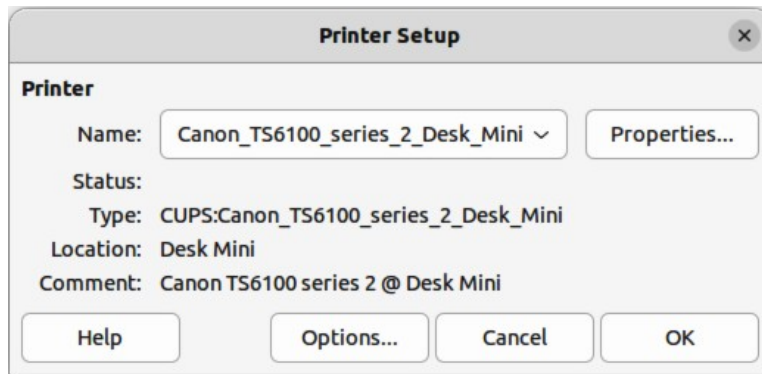

Figure 13: Example of a Printer Setup dialog

- 3) Click on **Options** in Printer Setup dialog to open the Printer Options dialog. Figure 14 shows an example of a Printer Options dialog.
- 4) Select the required printer options, then click on **OK** to save the selection and close the Printer Options dialog.

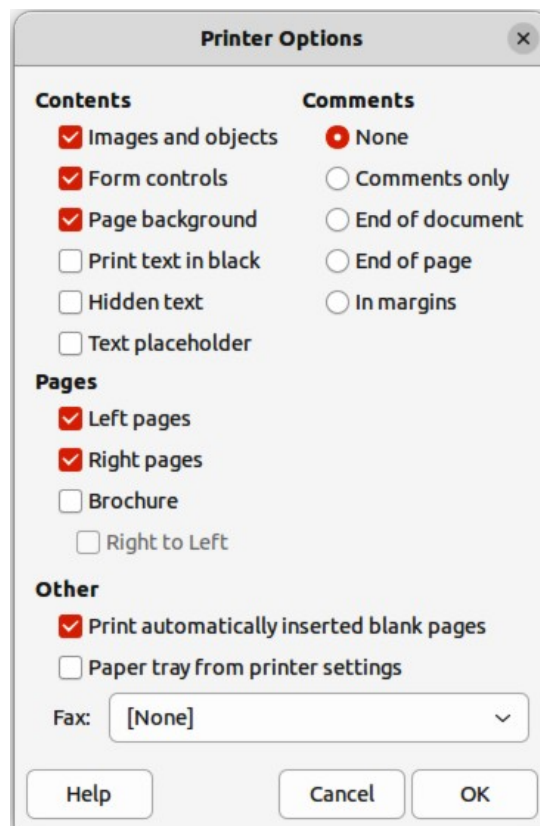

Figure 14: Example of Printer Options dialog

- 5) If necessary, click on **Properties** in the Printer Setup dialog to open a properties dialog for the default printer.
- 6) Select the required properties, then click on **OK** to save the selection and close the properties dialog.
- 7) Click **OK** to save the printer setup and close the Printer Setup Dialog.

LibreOffice printing options

General printing options

After you install a printer on a computer, the general printing options for LibreOffice can be customized. Go to **Tools > Options > LibreOffice > Print** (macOS **LibreOffice > Preferences > LibreOffice > Print**) to open the Options LibreOffice Print dialog (Figure 15). The general print options for LibreOffice are as follows:

Settings for

Specifies whether the print settings apply to direct printing or to printing to a file.

Defaults

Convert colors to grayscale

Specifies that all colors in a document are printed only as greyscale.

Include transparent objects

If selected, the reduction in print quality for bitmaps also applies to the transparent areas of objects.

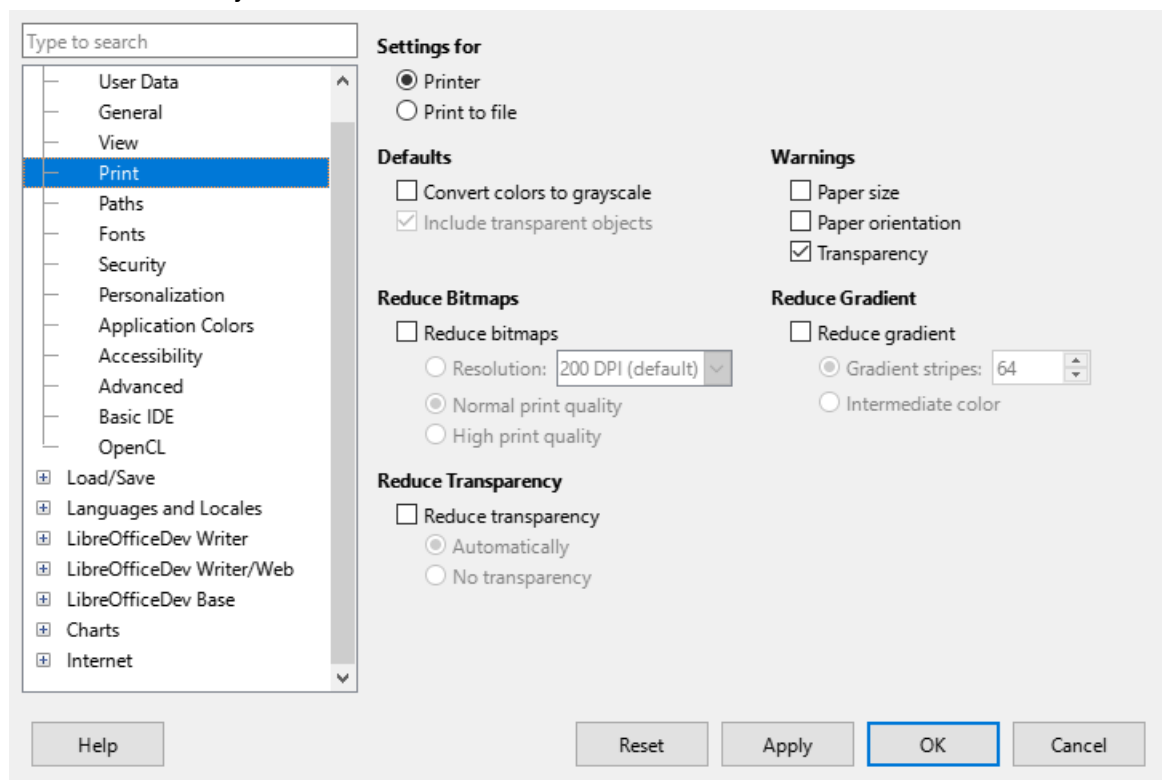

Figure 15: Options LibreOffice Print dialog

Reduce bitmaps

Specifies that bitmaps are printed with reduced quality. The resolution can only be reduced and not increased.

Resolution

Specifies the maximum print quality in DPI. The resolution can only be reduced and not increased.

High print quality

High print quality corresponds to a resolution of 300dpi.

Normal print quality

Normal print quality corresponds to a resolution of 200dpi.

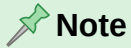

Note

Reducing the amount of data sent by LibreOffice to the printer increases the print speed because the print files are smaller. This makes it easier for printers with a smaller memory when printing large files. However, reducing print data can result in slightly lower print quality.

Reduce transparency

If selected, transparent objects are printed like normal, non-transparent objects, depending on your selection in the following two option buttons.

Automatically

Specifies that the transparency is only printed if the transparent area covers less than a quarter of the entire page.

No transparency

When selected, a transparency does not print.



Note

Transparencies cannot be sent directly to a printer. Transparencies must be visible to be calculated by LibreOffice as bitmaps and sent to the printer. Depending on bitmap size and the print resolution, a large amount of data may be generated.

Warnings

Defines which warnings appear before printing begins.

Paper size

Select this option if a certain paper size is required for printing the current document. If the paper size used in the document is not provided by the current printer, an error message opens.

Paper orientation

Select this option if a certain paper orientation is required for printing the current document. If the format used by the current document is not available from the printer, an error message opens.

Transparency

Select this option if a warning is required if transparent objects are contained in the document. When printing a document with transparencies, a dialogue box opens to enable selection if the transparency is to be printed.

Reduce gradient

If selected, gradients are printed with reduced quality.

Gradient stripes

Specifies the maximum number of gradient stripes for printing.

Intermediate color

Specifies that gradients are only printed in a single intermediate color.

LibreOffice modules printing options

To open the printing options dialog for each LibreOffice module, go to **Tools > Options > LibreOffice module name > Print** (macOS **LibreOffice > Preferences > LibreOffice module name > Print**). The different print settings for each LibreOffice module are summarized in Table 7. For more information, refer to the specific user guide for each module.

Table 7: Print options in LibreOffice modules

Feature	Writer	Calc	Impress	Draw	Math
Select pages, sheets, or slides to print	Yes	Yes	Yes	Yes	Yes
Print multiple pages, sheets, or slides on one page	Yes	Yes	Yes	Yes	No
Print a brochure	Yes	No	Yes	Yes	No
Print envelopes	Yes	No	No	No	No
Print labels or business cards	Yes	No	No	No	No
Preview pages or sheets before printing	Yes	Yes	No	No	No

Controlling printing

For more control over printing, open the Print dialog with one of the following methods:

- Go to **File > Print** on the Menu bar.
- Use the keyboard shortcut *Ctrl+P* (macOS $\text{⌘}+P$).
- Click on **Print** on the Standard toolbar.

General printing options — Windows or Linux

These printing options are available in the Impress Print dialog's General page for Windows or Linux (Figure 16).

Printer

Select the printer to use from the printers available in the drop-down list.

Properties

Click on **Properties** to open the properties dialog for the printer being used. The options available in this dialog depends on the type of printer connected to the computer and the computer operating system being used.

Range and Copies

All Slides

Prints all the slides in the presentation.

Selection

Prints the slides selected in LibreOffice Impress.

Slides

Select the page number(s) to print. For multiple pages, use the format 1, 3, 7 or 1 – 5, 7, 9 for page number selection.

Include

Select from the drop-down list *Odd and Even Pages*, *Odd Pages*, or *Even Pages*.

More > Paper sides

Select from the drop-down list *Print on one side (simplex)*, *Print on both sides (duplex long edge)*, or *Print on both sides (duplex short edge)*.

More > Number of copies

Enter number of printed copies required for the document.

More > Collate

Collates multiple printed copies into separate documents.

More > Order

Select from *Create separate print jobs for collated output* (only available when more than one copy is being printed) or *Print in reverse order*.

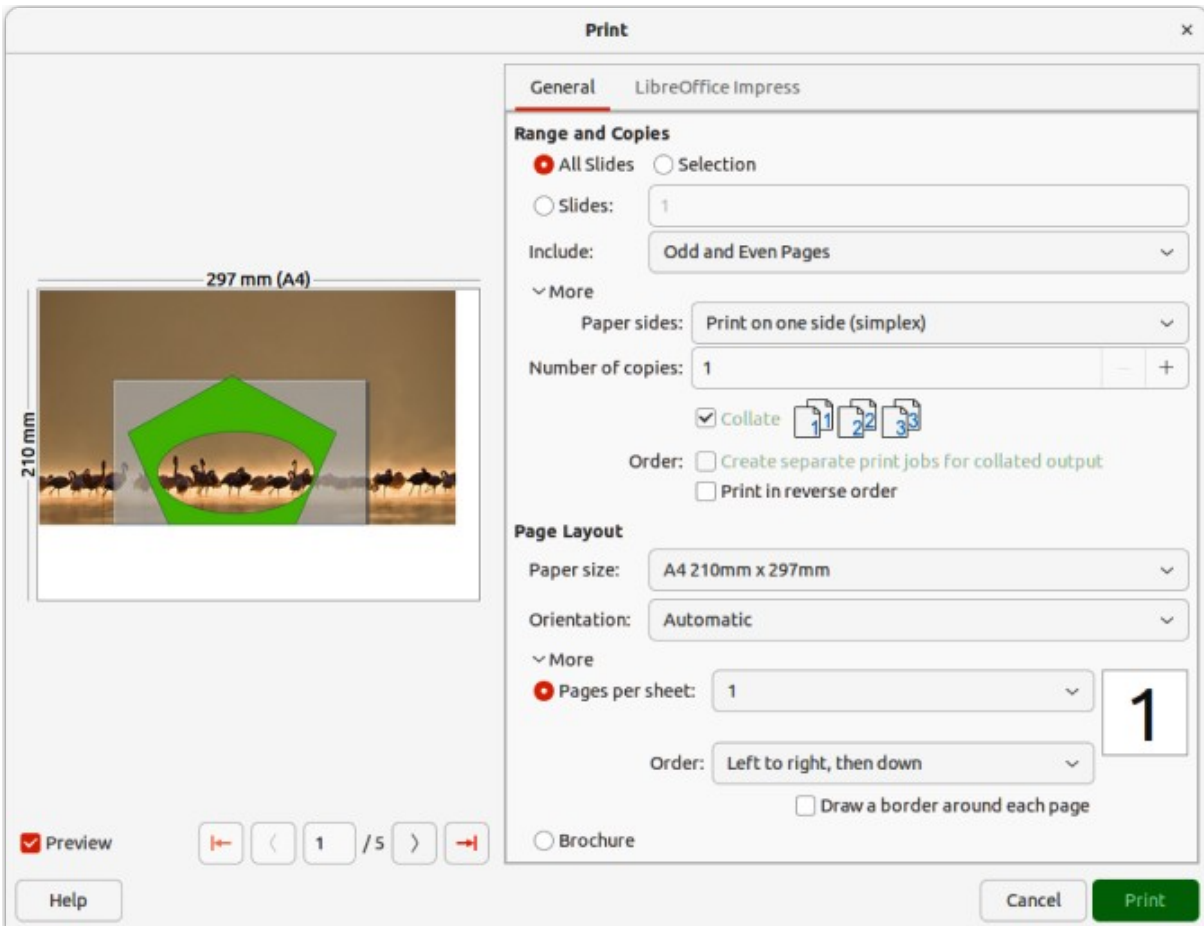

Figure 16: Impress Print dialog — Impress General page — Windows or Linux

Page Layout

Paper size

Select the paper size to use from the drop-down list.

Orientation

Select from the drop-down list *Automatic*, *Portrait*, or *Landscape*.

More > Pages per sheet

Select from the drop-down list how many pages are printed on one sheet of paper.

More > Order

Select from the drop-down list the printing order of multiple pages on one sheet of paper.

More > Draw a border around each page

When multiple slides are printed on one sheet of paper, a border is drawn around each slide.

More > Brochure

Prints the document so the pages can be folded into a brochure or booklet.

General printing options — macOS

The following general options are an example of the options available on the General page of the Impress Print dialog in macOS (Figure 17).

Printer

Select the printer to be used from the drop-down list. If the default printer is being used, then this printer will already be selected.

Presets

Select from the drop-down list a printing preset. The presets available depend on the type of printer connected to the computer. This also includes any custom presets that have been created.

Copies

Enter the number of copies to be printed.

Pages

All

Prints all the pages in the document.

From: to:

Select the page number(s) to print. For multiple pages, use the format 1, 3, 7 or 1–5, 7, 9 for page number selection.

Print in Color

If the printer selected is capable of color printing, this selection can be switched off to print the presentation in monochrome.

Double-Sided

Select this option to print the presentation double sided if the printer selected is capable of double sided printing.

Media & Quality

Feed from

Allows you to select which paper tray to use from a drop-down list (if the printer has more than one paper tray).

Media Type

Select the paper type that has been loaded into the paper tray from the drop-down list, (for example Envelope, Photo, Plain Paper).

Quality

Select the required level of printing quality.

Layout

Pages per sheet

Select how many slides are printed on one sheet of paper from the drop-down list.

Layout Direction

Select the printing order of multiple slides on one sheet of paper.

Border

When multiple slides are printed on one sheet of paper, a border is drawn around each slide.

Two-Sided

Determine how a multi-page document will be bound from a drop-down list: *Off*; *Long-Edge binding*; *Short-Edge binding*, *Booklet*.

Reverse page orientation

If LibreOffice prints the slides in the wrong order, select this option and print the document again.

Flip horizontally

If LibreOffice prints the pages in the wrong orientation, select this option and print the document again.

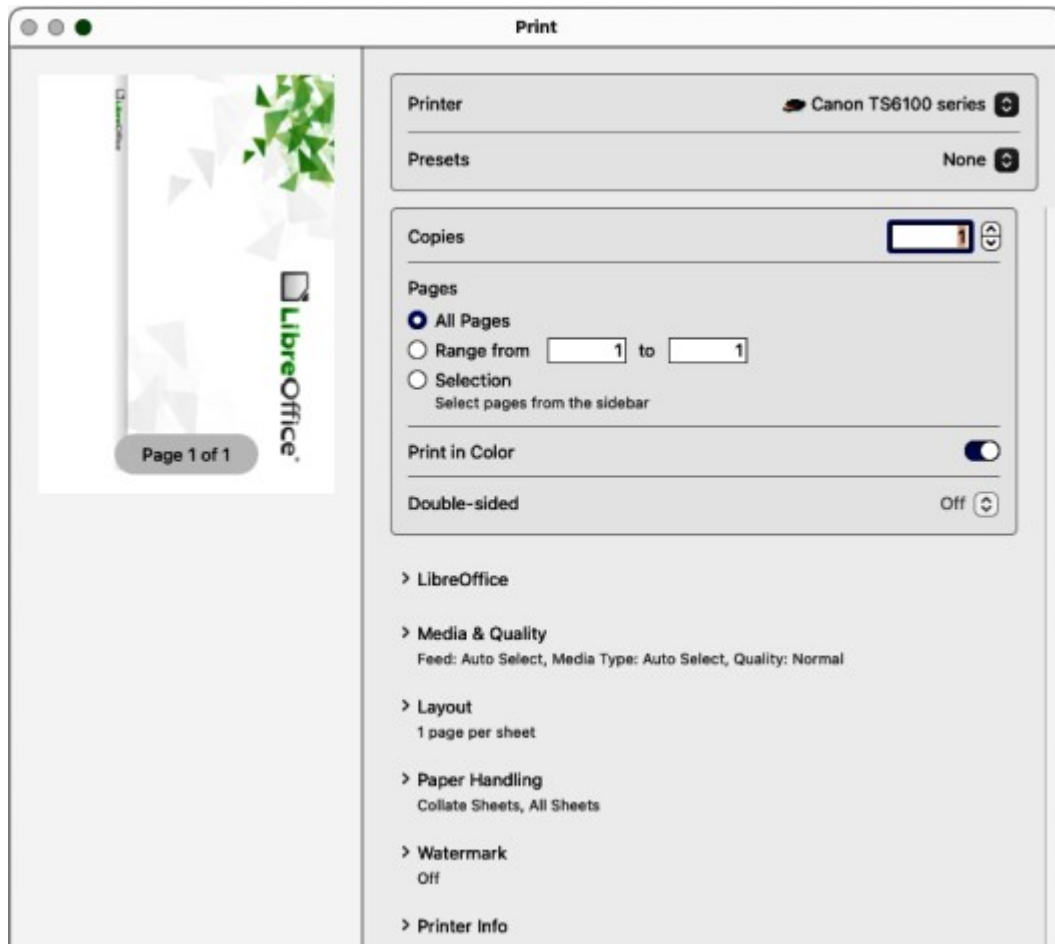

Figure 17: Print dialog — Impress General page — macOS

Paper Handling

Collate sheets

Allows selected multiple printed copies to be collated into separate documents.

Sheets to Print

Select which slides in the document to print from the drop-down list: (*All pages*; *Odd only*; *Even only*).

Sheet Order

Selects the page printing order from the drop-down list: *Automatic*; *Normal*; *Reverse*.

Scale to fit paper size

Adjusts the printed slide to fit the paper size.

Destination Paper Size

Only available if *Scale to fit paper size* has been selected. Selects a paper size from the options available in the included drop-down list.

Scale down only

Select this option to reduce slide size to fit the paper. Only available if the paper size is smaller than the slide size.

Watermark

Provides options to print watermark text on the slides, for example *Confidential* if the presentation is of a sensitive nature.

Printer info

Shows the details of the selected printer.

LibreOffice module printing options

For more information on using specific printing options available in each LibreOffice module, see the *User Guide* for each LibreOffice module. For example, specific printing could be for:

- Individual pages, slides, or drawings.
- Range of pages, slides, or drawings.
- Selection of text, or graphics (Writer).
- Individual sheets, range of sheets, or selected cells (Calc).
- Handouts, outlines, or notes (Impress).
- Envelopes, labels, or business cards (Writer).

Brochure printing

In Writer, Impress, and Draw, documents can be printed in the correct order to form a booklet or brochure. Below are some examples. Actual brochure printing procedure depends on the computer operating system and type of printer being used. You may need to experiment to find the correct method for brochure printing.

Single sided printing

This is an example of how you can create a brochure or booklet with a printer that can only print single sided pages.

- 1) Open the Print dialog using one of the following methods:
 - Go to **File > Print** on the Menu bar.
 - Use the keyboard shortcut *Ctrl+P* (macOS +P).
 - Click on **Print** on the Standard toolbar.
- 2) Click on **General** to open the page for general print options and, if necessary, select a printer from the **Printer** drop-down list of printers available.
- 3) Click on **Properties** to open the printer properties dialog for the printer being used and check the printer is set to the same page orientation as specified for the page setup for the pages. Usually page orientation does not matter, but it is important for brochures.
- 4) Click **OK** to close the properties dialog and return to the Print dialog.
- 5) In **Range and Copies**, select *All Slides*. A minimum of four slides is required to create a brochure.

- 6) In **Range and Copies**, select the *Number of copies* required to match the required number of brochures.
- 7) In **Layout**, select *Brochure*.
- 8) In **Range and Copies**, select *Even slides* option in *Include*.
- 9) Click **OK** to print the even slides in the presentation.
- 10) Take the printed pages out of the printer and put them back into the printer in the correct orientation to print on the other side of the paper. It may be necessary to experiment to find out the correct arrangement for the printer being used.
- 11) In **Range and Copies**, select *Odd slides* option in *Include*.
- 12) In **Range and Copies**, select the same *Number of copies* used for printing the even slides.
- 13) Click **OK** to print the odd slides in the presentation and close the Print dialog.
- 14) Assemble the brochures and bind them, if necessary.

Double sided or duplex printing

Printing a brochure with a printer that is capable of double sided, or duplex printing, makes the task of creating brochures simpler.

- 1) Open the Print dialog using one of the following methods:
 - Go to **File > Print** on the Menu bar.
 - Use the keyboard shortcut *Ctrl+P* (macOS +P).
 - Click on **Print** on the Standard toolbar.
- 2) Click on **General** to open the page for general print options and, if necessary, select a printer from the **Printer** drop-down list of printers available.
- 3) Click on **Properties** to open the printer properties dialog for the printer being used and check the printer is set to the same page orientation (as specified for the page setup for the slides). Page orientation is especially important for brochures.
- 4) Click **OK** to close the properties dialog and return to the Print dialog.
- 5) In **Range and Copies**, select *All Slides*. A minimum of four slides is required to create a brochure.
- 6) In **Range and Copies**, select *Print on both sides (duplex long edge)* or *Print on both sides (duplex short edge)* option. Normally, long edge binding is used for portrait printing and short edge binding is used for landscape printing.
- 7) In **Range and Copies**, select the *Number of copies* required to match the required number of brochures.
- 8) In **Range and Copies**, select the *Collate* option. This option is only active when printing multiple copies of the same document.
- 9) In **Layout**, select *Brochure*.
- 10) Click **OK** to close to the Print dialog and print the required number of pages for the brochures.
- 11) If necessary, bind the brochures to match either long edge or short edge binding.

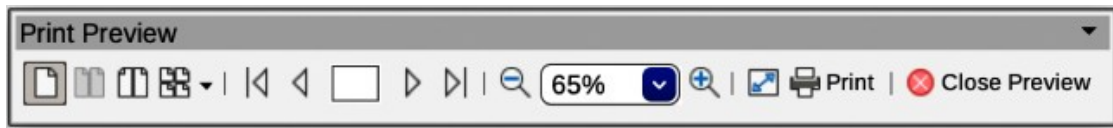

Figure 18: Print Preview toolbar

Print previewing

A document can be previewed before it is printed in the Writer and Calc modules. Print previewing is useful, especially when printing a document double-sided making sure there are no errors before the document is printed. Print previewing is opened as follows:

- 1) Open **Print Preview** using one of the following methods. The Print Preview toolbar (Figure 18) opens and the Formatting toolbar closes:
 - Go to **File > Print Preview** on the Menu bar.
 - Click on **Toggle Print Preview** on the Standard toolbar.
 - Use the keyboard shortcut *Ctrl+Shift+0* (macOS **⌘**+*Shift+0*).
- 2) Select the required preview from **Single Page Preview**, **Two Pages Preview**, **Book Preview**, or **Multiple Pages Preview**.
- 3) To print the document from **Print Preview**, click **Print** on the Print Preview toolbar to open the Print dialog, then select the printing options and click **OK** (macOS **Print**).
- 4) To close the preview, click on **Close Preview** on the Print Preview toolbar. The document switches back to normal view and the Formatting toolbar reopens replacing the Print Preview toolbar.

Note

When a document is in **Print Preview mode**, the document cannot be edited. If necessary, click on **Book view** in the Status Bar to display the document in book format. The document can be edited when using **Book view** on the Status bar. Click on **Single page view** to return the document to normal view.

Using Safe Mode

Safe Mode is used to restore LibreOffice after it has stopped working, fails to launch correctly, or a file has become corrupted. It starts LibreOffice with a fresh user profile and disables hardware acceleration.

Go to **Help > Restart in Safe Mode** on the Menu bar to open the Safe Mode dialog (Figure 19).

Note

It is recommended to use Safe Mode options from the top down (Figure 19) because the options get more extreme from the top down.

Restore from backup

If you suspect that the problems were caused by recent changes to LibreOffice's working state, this option may help you. Since LibreOffice keeps backups of previous configurations and activated extensions, Restore from backup will allow you to restore the user configuration, installed extensions (or both), to a previous known working state.

Configure

This Safe Mode option disables either all user extensions, hardware acceleration, or both functions. This may help you if there are crashes on startup or visual glitches that are often related to hardware acceleration.

Extensions

If you think that a corrupted extension is blocking or causing LibreOffice to crash, this option will uninstall all user extensions and reset the state of any shared or bundled extensions. In the case of shared, or bundled extensions, the option only works if a user has the proper system access rights. It should be used with caution.

Reset to factory settings

If all of the above fails, this function will reset the settings and user interface modifications (or the entire user profile) back to factory defaults.

Reset settings and user interface modifications

This function resets any user interface and configuration changes, but keeps items such as personal dictionary, templates, and so on.

Reset entire user profile

This function erases all customized options and returns a user profile to the factory default state.

Continue in Safe Mode

If you need to continue in Safe Mode, it allows you to work in LibreOffice with a temporary profile that was created on startup. Any extensions or configuration options set up previously have to be reconfigured before using. Keep in mind that any changes made to the temporary user profile are lost after a restart.

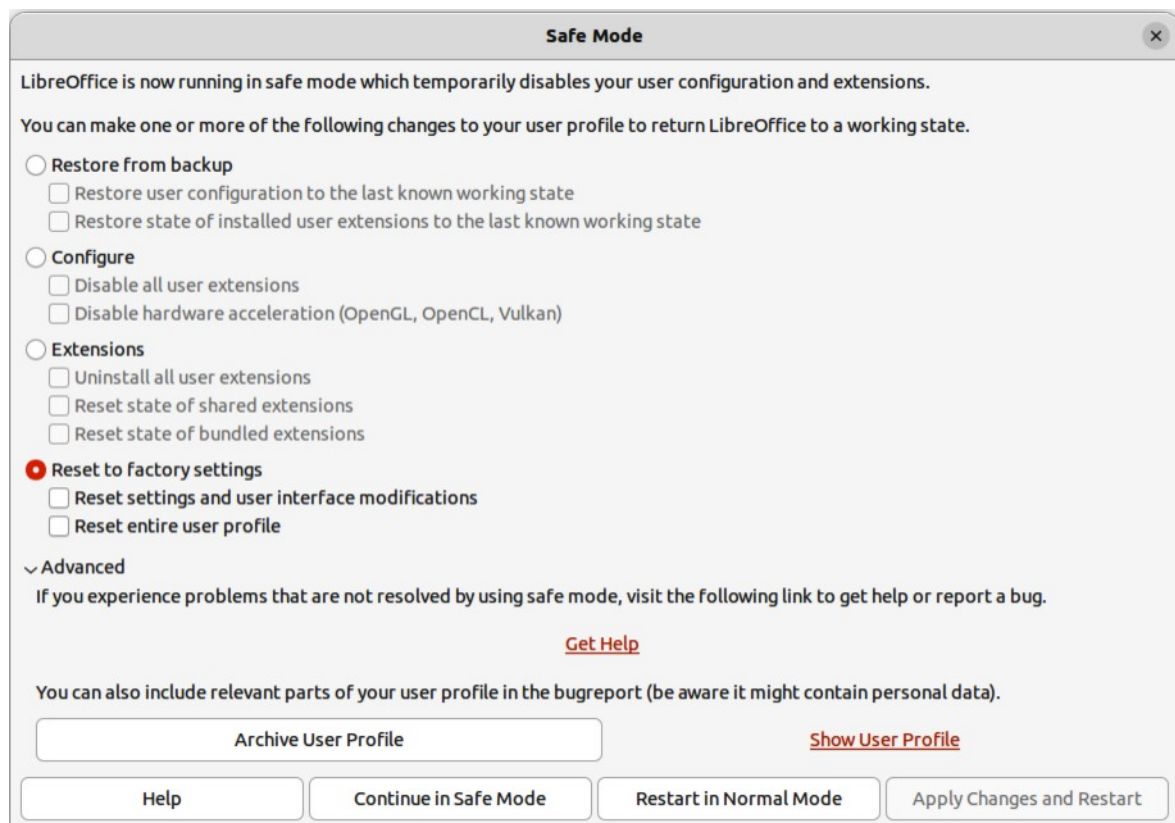

Figure 19: Safe Mode dialog

Restart in Normal Mode

If you have started Safe Mode accidentally, this option discards any changes, terminating Safe Mode, and restarting LibreOffice normally.

Apply Changes and Restart

Select this option to apply any of the above changes and restart LibreOffice.

Note

If problems are not solved using Safe Mode, selecting **Advanced** provides instructions on receiving further aid.

Advanced can allow you to create a zip file of a corrupted user profile, and this file can be uploaded to the bug tracking system for further investigation by the LibreOffice developers. Remember that an uploaded user profile may also contain sensitive information such as installed extensions, personal dictionaries, and user-specific settings.



LibreOffice
Community



Chapter 2, Getting Started with Writer

Word processing with LibreOffice

What is Writer?

Writer is the word processor component of LibreOffice. In addition to the usual features of a word processor (spelling check, thesaurus, hyphenation, autocorrect, find and replace, automatic generation of tables of contents and indexes, mail merge, and others), Writer provides these important features, which are covered in detail in the *Writer Guide*:

- Templates and styles (see Chapter 4)
- Page layout methods, including styles, frames, columns, and tables
- Automated tables of contents and indexes
- Embedding or linking of images, equations, spreadsheets, and other objects
- Built-in drawing tools
- Master documents, to group a collection of documents into a single document
- Change tracking during revisions
- Lists
- Tables of data
- Database integration, including a bibliography database
- Mail merge
- Export to PDF and EPUB (see Chapter 10)
- Document digital signatures
- Form design and filling
- And many more

The Writer interface

The main Writer workspace is shown in Figure 20. The default menus and toolbars are described in Chapter 1, *Introducing LibreOffice*. Some other features of the Writer interface are covered in this chapter. Other user interface variants are described in Chapter 13, *Customizing LibreOffice*.

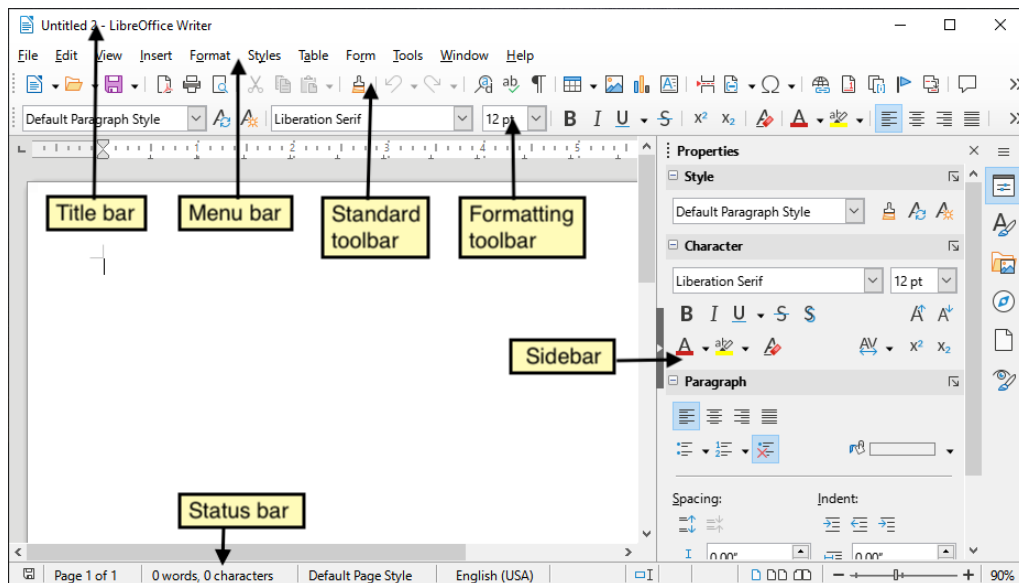

Figure 20: The main Writer workspace

Status bar

The Writer Status bar provides information about the document and convenient ways to change some document features quickly.



Figure 21: Writer Status bar, left end

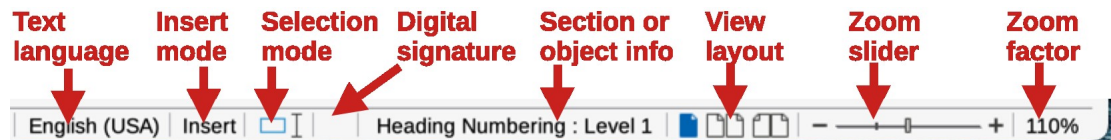

Figure 22: Writer Status bar, right end

Document changes status

The icon changes color to indicate whether the document has no unsaved changes or it has been edited and the changes have not been saved. When there are unsaved changes, you can click on this icon to save the document.

Page number

Shows the sequence number of the current page, and the total number of pages in the document, and the current page number (if different from the sequence number). For example, if you restarted page numbering at 1 on the third page, its page number is 1 and its sequence number is 3.

If any bookmarks have been defined in the document, a right-click on this field pops up a list of bookmarks; click on one to go to that location.

To jump to a specific page in the document, click on this field. A small Go to Page dialog pops up. Type the required page number and click **OK** or press *Enter*.

Word and character count

The word and character counts of the document are kept up to date as you edit. When text is selected, the word and character counts for the selection will appear here.

The character count includes spaces. To display the character count excluding spaces, click on the word count in the Status bar, or choose **Tools > Word Count**.

You can also see the number of words and characters (and other information including the number of pages, tables, and graphics) in the entire document in **File > Properties, Statistics** tab.

Page style

Shows the style of the current page. To select a different page style, right-click on this field. A list of page styles pops up; click on one to select it. To edit the attributes of the current page style, left-click on this field. The Page Style dialog opens.

Caution

Changing the page style here may affect the styles of subsequent pages, depending on how the page styles are set up. See the *Writer Guide* for details.

Text language

Shows the language and localization at the cursor position, or for the selected text, that is used for checking spelling, grammar, hyphenation, and the thesaurus.

Click to open a menu where you can choose another language or localization for the selected text or for the paragraph where the cursor is located. You can also choose **None (Do not check spelling)** to exclude the text from a spelling check or choose **More** to open the Character dialog. Any directly formatted language settings can be reset to the default language from this menu.

Insert mode

Click to change to Overwrite mode; click again to return to Insert mode. In Insert mode, any text after the cursor position moves forward to make room for the text you type; in Overwrite mode, text after the cursor position is replaced by the text you type. This feature is disabled when in Record Changes mode.

Selection mode

Click to cycle between the selection modes; right-click to select the required mode from a context menu. The icon does not change, but when you hover the mouse pointer over this field, a tooltip indicates which mode is active.

Mode	Effect
Standard selection	Click in the text where you want to position the cursor and drag to where you want the selection to end. Any previous selection is deselected.
Extending selection (<i>F8</i>)	Clicking in the text extends or crops the current selection.
Adding selection (<i>Shift+F8</i>)	A new, separate selection is added to an existing selection. The result is a multiple selection.
Block selection (<i>Alt+Shift+F8</i>)	A block of text can be selected.

On Windows systems, you can hold down the *Alt* key while dragging to select a block of text. You do not need to enter the block selection mode.

Digital signature

If the document has been digitally signed, an icon is displayed here; otherwise, it is blank. To sign the document, or to view the certificate, click the area or icon. See Chapter 10, Working with File Formats, Security, and Exporting, for more information.

Section or object information

When the cursor is in a section, heading, or list item, or when an object (such as a picture or table) is selected, information about that item appears in this field. Clicking in this area opens a relevant dialog. For details, consult the Help or the *Writer Guide*.

View layout

Click an icon to change between single page, multiple pages, and book layout views (Figure 23). You can edit the document in any view. Zoom settings interact with the selected view layout and the window width to determine how many pages are visible in the window.

Zoom

To change the view magnification, drag the Zoom slider, or click on the + and – signs, or right-click on the zoom level percent (Zoom factor) to pop up a menu of magnification values from which to choose, or click on the zoom level percent to pop up the Zoom & View Layout dialog where you can specify other magnification values.

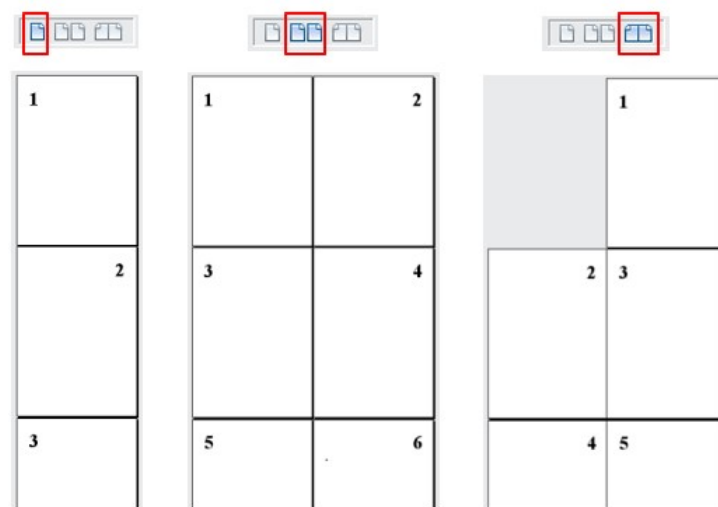

Figure 23: View layouts: single page, multiple pages, book

Sidebar

The Sidebar is normally open by default on the right side of the Writer window. If necessary, select **View > Sidebar** on the Menu bar, or press *Ctrl+F5*, to display it. An example is shown in Chapter 1, LibreOffice Basics.

The Writer Sidebar contains eight decks by default: Properties, Styles, Gallery, Navigator, Page, Style Inspector, Manage Changes, Accessibility Check, and Find. Each deck has a corresponding icon on the Tab bar on the right of the Sidebar, allowing you to switch between them. The decks are described below.

Each deck consists of a title bar and one or more content panels. Some panels contain a small **More Options** button, which opens a dialog to give greater choice of editing controls. When the dialog is open, the document is locked for other editing.

Properties deck: Contains tools for direct formatting of content.

When text is selected, these panels appear:

- *Style*: Apply a paragraph style at the cursor position. Create or update a style.
- *Character*: Modify text by the font type, size, color, weight, style, and spacing.

- *Paragraph*: Modify the paragraph by alignment, lists or bullets, background color, indent, and spacing.

When the cursor is in a *table*, this panel appears in addition to the panels for text:

- *Table*: Modify table properties, such as insert, select, delete rows and columns; split or merge cells; set row height and column width; others.

When a graphic or image is selected, these panels appear:

- *Area*: Modify the image background fill and transparency. Further colors, gradients, hatching, patterns, and image selection and importing are available in **More Options**.
- *Wrap*: Modify wrap and spacing where these are available.
- *Image*: Modify the image brightness, contrast, color mode, and transparency.
- *Position and Size*: Modify width, height, rotation, and flip attributes.

When a drawing object is selected, these panels appear:

- *Area*: Modify fill and transparency.
- *Wrap*: Modify wrap and spacing where these are available.
- *Position and Size*: Modify width, height, rotation, and flip attributes.
- *Line*: Modify style, width, color, and transparency.
- *Effect*: Add and adjust a Glow or Soft Edge effect to the object.

When a frame is selected, then the *Area* and *Wrap* panels appear.

When a video or audio clip is selected, these panels appear:

- *Media Playback*: Control for play, pause, stop, seek, loop, and volume.
- *Position and Size*: Modify width and height.

Styles deck: Manages the styles used in the document. This includes applying existing styles, modifying them, or creating new ones. See Chapter 4, Working with Styles, Templates, and Hyperlinks, for more information.

Gallery deck: Contains images and diagrams included in the Gallery themes. The Gallery has two sections. The first lists the themes by name (*Arrows*, *Bullets*, *Diagrams*, etc.) and the second displays the images in the selected category. Select the **New** button to create new categories. To insert an image into a file, create new gallery themes, or add a new image to the new category, see Chapter 5, Working with Images and Graphics, for more information.

Navigator deck: Makes it easy to navigate to specific types of content and to reorganize contents based on categories, such as headings, tables, frames, images, and so on. See “Using the Navigator” on page 68 for more information.

Page deck: Modifies the page style to change the most commonly used page properties. It has four panels:

- *Format* modifies the size, width, height, orientation, and page margins.
- *Styles* modifies the numbering scheme, background, page layout (specifies whether the page style should apply to odd or even pages or to both), and columns.
- *Header* and *Footer* activate/deactivate and modify the respective margins, spacing, and content.

Caution

Changing the options on the Page deck modifies the page style in use, affecting not only the current page but all pages in the document using the same page style.

Style Inspector deck: Displays all the attributes of paragraph styles, character styles, and manual (direct) formatting for selected text. For more information, see the *Writer Guide*.

Manage Changes deck: Lists tracked changes that have not yet been accepted or rejected. You can accept or reject them here as well as in the Manage Changes dialog or the Track Changes toolbar.

Accessibility Check deck: Lists accessibility issues found in the document. Each entry in this deck represents an accessibility problem and to jump to the location of the problem, double-click on that particular entry. More information about this deck can be found in the Writers Guide (Chapter 7, Printing and Publishing).

Find deck: Type a search term or phrase in the box at the top, then press *Enter* to display a list of the results and their context. For more information, see page 71.

Changing document views

Writer has three ways to view a document: Normal, Web, and Full Screen. To change the view, go to the View menu and select the desired view.

Normal view

Normal view is the default view in Writer. It shows how the document will look when you print it or create a PDF. In this view, you can hide or show the headers and footers and the gap between pages by choosing **View > Show Whitespace** on the Menu bar. This works only when single-page view is activated on the Status Bar. Hiding whitespace also works in Full Screen view.

Web view

Web view shows how the document will look if viewed in a Web browser; this is useful when you create HTML documents. In Web view, you can use only the Zoom slider; the View Layout buttons on the Status Bar are disabled, and most of the choices on the Zoom & View Layout dialog are not available. There is no visual indication of page boundaries.

Full Screen view

In Full Screen view, no toolbars or sidebar are displayed; the document takes up the full area available, using the zoom and layout settings previously selected. To exit Full Screen view and return to the previous view, press the *Esc* key or click the **Full Screen** button on the floating toolbar in the top left-hand corner. You can also use *Ctrl+Shift+J* to toggle between Full Screen and the previous views.

Working with documents

Chapter 1, LibreOffice Basics, includes instructions on creating new documents, opening existing documents, and saving documents. Chapter 4, Working with Styles, Templates, and Hyperlinks, covers how to create a document from a template.

By default, LibreOffice creates and saves files in the OpenDocument format (ODF). Writer documents have the extension .ODT.



Tip

Whenever it is possible to choose the document file format, you should choose to work with the default ODF format. This reduces the likelihood of errors and compatibility issues.

Saving as a Microsoft Word file

You may need to open, edit, and save documents in Microsoft Word formats. You can also create and edit .ODT files and then save them as .DOCX or .DOC files. To do this:

- 1) Important — First save your document in the file format used by LibreOffice Writer (.ODT). If you do not, any changes you made since the last time you saved will appear only in the Microsoft Word version of the document. Also, saving in ODF format enables you to re-save or modify the document if the recipient of the document experiences trouble with the Microsoft format.
- 2) Then choose **File > Save As**.
- 3) On the Save As dialog, in the *File type* drop-down menu, select the Word format you need. You may also choose to change the file name.
- 4) Click **Save**.

This creates a separate document with a different file extension (such as .DOCX). From this point on, all changes you make to the document will occur only in the new document. If you want to go back to working with the .ODT version of your document, you must open it again.



Tip

To have Writer save documents by default in a Microsoft Word file format, go to **Tools > Options > Load/Save > General**. In the section named *Default File Format and ODF Settings*, under *Document type*, select **Text document**, then under *Always save as*, select your preferred file format.

Exchanging documents with users of Apple Pages

Although Writer can open and edit files in Apple Pages format (*.pages), it cannot save in that format or export to that format. Apple Pages cannot open files in OpenDocument format, so if you need to share files with users of Pages, save your .odt file in a compatible format, such as .rtf or .docx. If you attempt to save an edited .pages file, the Save As dialog opens.

Pages users can also export (not save) a copy of a Pages document in a format compatible with Writer, such as .docx or .rtf, which Writer can then open, edit, and save to.



Note

More information about different file formats can be found in Chapter 10, Working with File Formats, Security and Exporting.

Moving quickly through a document

Using the Navigator

The Navigator provides several convenient ways to move around a document and find items in it. It lists the headings, tables, text frames, graphics, bookmarks, and other objects in the document.

- When a category is showing the list of objects in it, double-click on an object to jump directly to that object's location in the document.
- In the top left of the Navigator is a *Navigate By* drop-down list. You can pick a type of object (such as a bookmark, table, or index entry) and then use the **Previous** (^) and **Next** (v) buttons to jump from one to the next (Figure 24).
- On the top right of the Navigator is a **Go to Page** field, which you can use to jump directly to a specific page.

For more uses of the Navigator in Writer, see the *Writer Guide*.

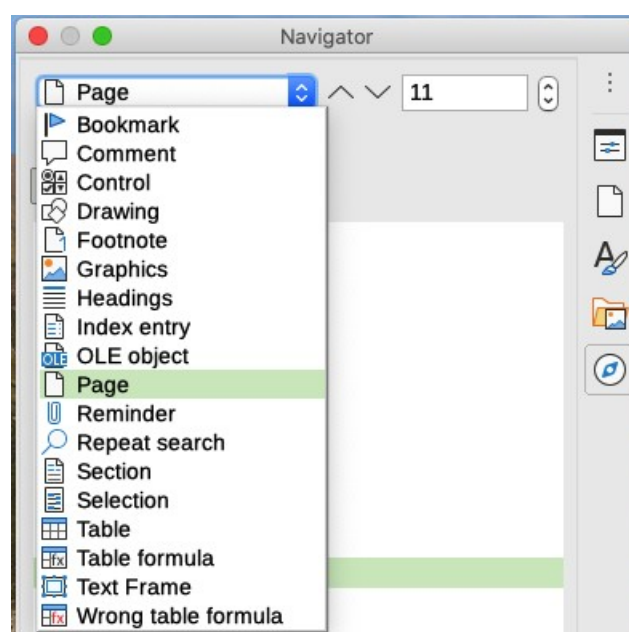

Figure 24: *Navigate By* list on Navigator

Using the Go to Page dialog

To jump to a specific page in the document:

- Use the Go to Page field on the top right of the Navigator (see above).
- Use the Go to Page dialog (Figure 25), which shows the current page number and the number of pages in the document. Type the number of the destination page in the text box and click **OK**. To open this dialog, do any of the following:
 - Click on the page number field in the Status bar.
 - Choose **Edit > Go to Page** on the Menu bar.
 - Press *Ctrl+G* on the keyboard.

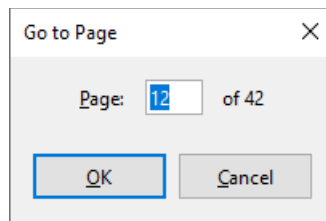

Figure 25: Go to Page dialog

Working with text

Selecting, copying, pasting, or moving text in Writer is similar to working with text in other programs. LibreOffice also has some convenient ways to select items that are not next to each other, select a vertical block of text, and paste unformatted text.

Selecting items that are not consecutive

To select non-consecutive items (as shown in Figure 26) using the mouse:

- 1) Select the first piece of text.
- 2) Hold down the *Ctrl* key and use the mouse to select the next piece of text.
- 3) Repeat as often as needed.

To select non-consecutive items using the keyboard:

- 1) Select the first piece of text.
- 2) Press *Shift+F8*. This puts Writer in “Adding selection” mode.
- 3) Use the arrow keys to move to the start of the next piece of text to be selected. Hold down the *Shift* key and select the next piece of text.
- 4) Repeat as often as required.

Now you can work with the selected text (copy it, delete it, change the style, and so on).

Press *Esc* to exit from this mode.

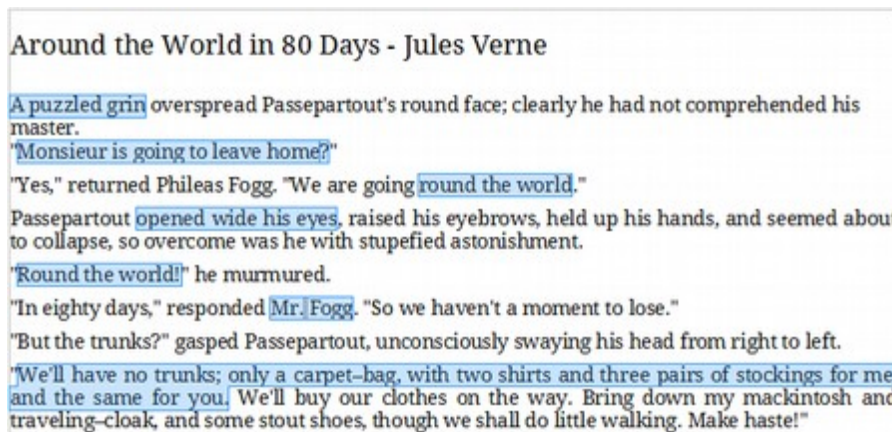

Figure 26: Selecting items that are not next to each other

For more information about keyboard selection of text, see the topic “Navigating and selecting with the keyboard” in LibreOffice Help (*F1*).

Selecting a vertical block of text

You can select a vertical block or “column” of text that is separated by spaces or tabs (as you might see in text pasted from e-mails, program listings, or other sources), using Block selection mode. To change to Block selection mode, use **Edit > Selection Mode > Block Area**, or press *Alt+Shift+F8*, or right-click on the **Selection** icon on the Status bar and select **Block selection** in the pop-up menu.

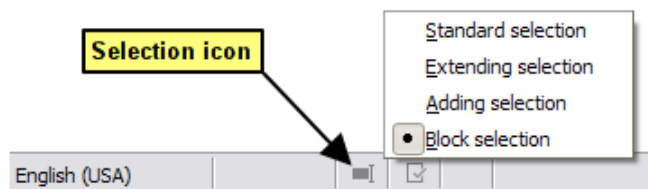

Figure 27: Selection icon

Now highlight the selection, using mouse or keyboard, as shown below.

January	February	March
April	May	June
July	August	September
October	November	December

Figure 28: Selecting a vertical block of text

Cutting, copying, and moving text

Cutting and copying text in Writer is similar to cutting and copying text in other applications. You can use the mouse or the keyboard. You can copy or move text within a document, or between documents, by dragging or by using menu selections, toolbar buttons, or keyboard shortcuts. You can also copy text from other sources such as Web pages and paste it into a Writer document.

To move (drag and drop) selected text using the mouse, drag it to the new location and release it. To copy selected text, hold down the *Ctrl* key while dragging. The text retains the formatting it had before dragging.

To move (cut and paste) selected text, use *Ctrl+X* to cut the text, insert the cursor at the paste-in point and use *Ctrl+V* to paste. Alternatively, use the **Copy / Paste** buttons on the Standard toolbar, or the options under **Edit** on the Menu bar.

To move an entire paragraph up or down in the document, click on the paragraph and press *Ctrl+Alt+Up* or *Ctrl+Alt+Down* respectively.

Pasting text

When you paste text, the result depends on the source of the text and how you paste it. If you click on the **Paste** button on the Standard toolbar or use *Ctrl+V*, any formatting the text has (such as bold or italics) is retained. Text pasted from websites and other sources may also be placed into frames or tables. If you do not like the results, click the **Undo** button or press *Ctrl+Z*.

To make the pasted text inherit the paragraph style at the insertion point, do any of the following:

- Choose **Edit > Paste Special**.
- Click the arrow on the **Paste** button on the Standard toolbar.
- Double-click the **Paste** button without releasing the left mouse button.

- Press *Ctrl+Shift+V*.

Then select **Paste Unformatted Text** or **Unformatted text** in the resulting menu. Unformatted text can also be pasted directly by pressing *Ctrl+Alt+Shift+V* on the keyboard.

Finding and replacing text and formatting

Writer has three ways to find text within a document: the Find toolbar and the Find deck in the Sidebar for fast searching, and the Find and Replace dialog. In the dialog, you can:

- Find and replace words and phrases
- Use wildcards and regular expressions to fine-tune a search
- Find and replace specific attributes or formatting
- Find and replace paragraph styles

Using the Find toolbar

By default, the Find toolbar is docked at the bottom of the LibreOffice window (just above the Status bar) as shown in Figure 29, but you can float it or dock it in another location. If the Find toolbar is not visible, you can display it by choosing **View > Toolbars > Find** on the Menu bar, selecting **Edit > Find** on the Menu bar, or by pressing *Ctrl+F*. For more information on floating and docking toolbars, see Chapter 1, LibreOffice Basics.

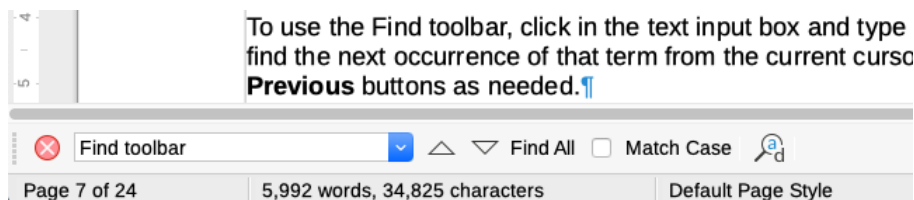

Figure 29: Docked position of Find toolbar

To use the Find toolbar, click in the box and type your search text, then press *Enter* to find the next occurrence of that term. Click the **Find Next** or **Find Previous** (arrow) buttons as needed.

Click the **Find All** button to select all instances of the search term within the document. Select **Match Case** to find only the instances that also match the case (capitalization). To open the Find and Replace dialog, click the icon to the right of **Match Case**.

To close the Find toolbar, click the **X** button on the left, or press *Esc* on the keyboard when the cursor is in the search box.

Using the Find deck in the Sidebar

The Find deck in the Sidebar is another handy tool to locate quickly all occurrences of text in the document.

- 1) Open the Find deck in the Sidebar (Figure 30) or use *Alt+9*.
- 2) Enter the text in the Find box on the top.
- 3) Press *Enter*.

LibreOffice locates all the text occurrences in the Find box and presents the results in the area just below with an indication of the page number and text portion of the occurrence. Click on the text found to jump to the page and highlight the search text found (Figure 30).

Note

The search is case insensitive.

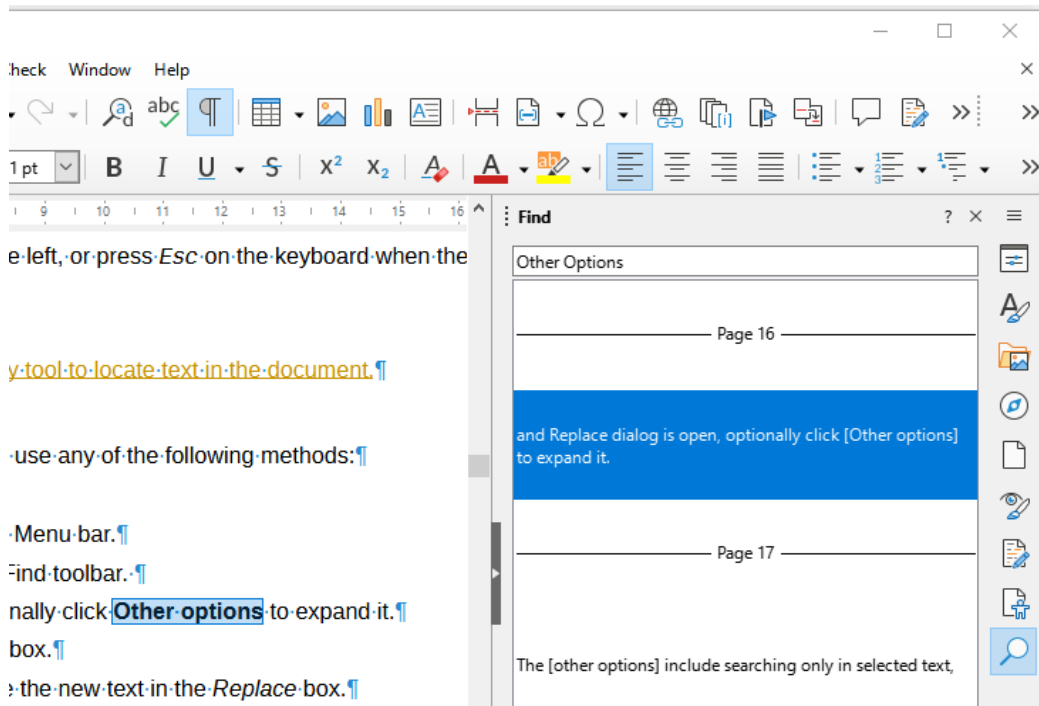

Figure 30: Find deck in Sidebar

Using the Find and Replace dialog

To display the Find and Replace dialog (Figure 31), use any of the following methods:

- Press **Ctrl+H** on the keyboard.
- Choose **Edit > Find and Replace** on the Menu bar.
- Click the **Find and Replace** icon on the Find toolbar.

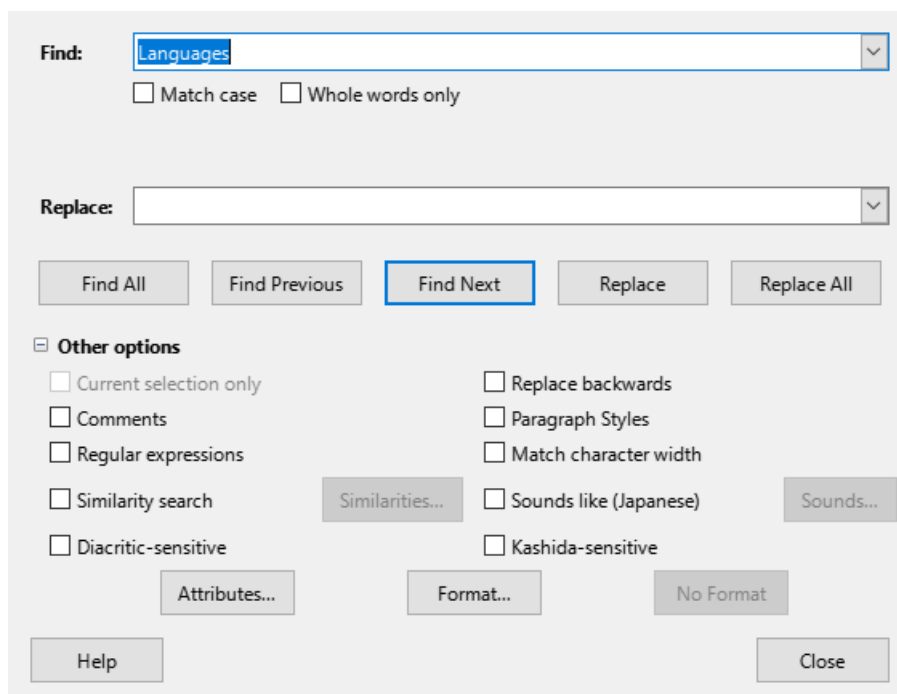

Figure 31: Expanded Find and Replace dialog

When the Find and Replace dialog is open, optionally click **Other options** to expand it.

- 1) Type the text you want to find in the *Find* box.
- 2) To replace the text with different text, type the new text in the *Replace* box.
- 3) You can select various options such as matching the case or matching whole words only.
- 4) The other options include searching only in selected text, searching from the current cursor position backwards toward the beginning of the file, searching for similar words, searching in comments, and using regular expressions (wildcards). The exact options may vary with your language settings (**Tools > Options > Languages and Locales > General**).
- 5) When you have set up the search, click **Find Next**. To replace the found text, click **Replace**. If you click **Find All**, LibreOffice selects all instances of the search text in the document. Similarly, if you click **Replace All**, LibreOffice replaces all matches, without stopping for you to accept each instance.



Caution

Use **Replace All** with caution; otherwise, you may end up with mistakes that you won't be able to undo later if you save and close the file. (*Ctrl+Z* works only before the file is saved.) A mistake with **Replace All** might require a manual, word-by-word, search to fix.



Tip

Regular expressions offer powerful ways to search and replace text. For example, they can find all instances where any number is followed by specific letters. However, they can be challenging to understand. Refer to the Help files for guidance.

For more information on using Find and Replace, see the *Writer Guide*.

Inserting special characters

A special character is one not found on a standard user's keyboard. For example, © ¼ æ ç ñ ö ø ¢ are all special characters not available on an English keyboard.

To insert one or more special characters, place the cursor where you want the character to appear. Then do one of the following:

- Click the **Special Character** icon on the Standard toolbar to open a list of favorite and recently used characters and click on the one you wish to insert (Figure 32). You can also open the Special Characters dialog (Figure 33) by clicking the **More Characters** button.

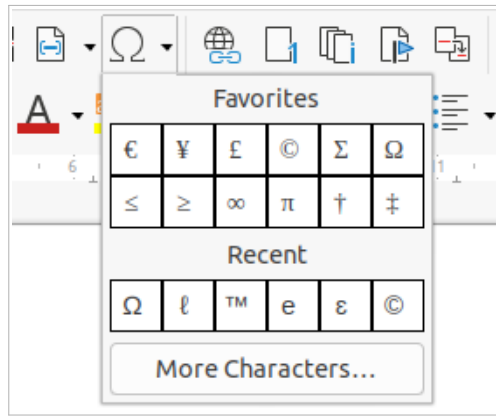

Figure 32: Insert Special Characters icon in the standard toolbar

- Choose **Insert > Special Character** on the Menu bar, to open the Special Characters dialog (Figure 33). Double-click the characters (from any font or mixture of fonts) you wish to insert, in order, then click **Insert**.

The Special Characters dialog (Figure 33) includes areas to select *Recent Characters* and *Favorite Characters*. To add a new character to the *Favorite Characters* list, click on a character and click the **Add to Favorites** button.

 **Tip**

Different fonts have their own distinct special characters. If you do not find a particular special character, try changing the *Font* selection.

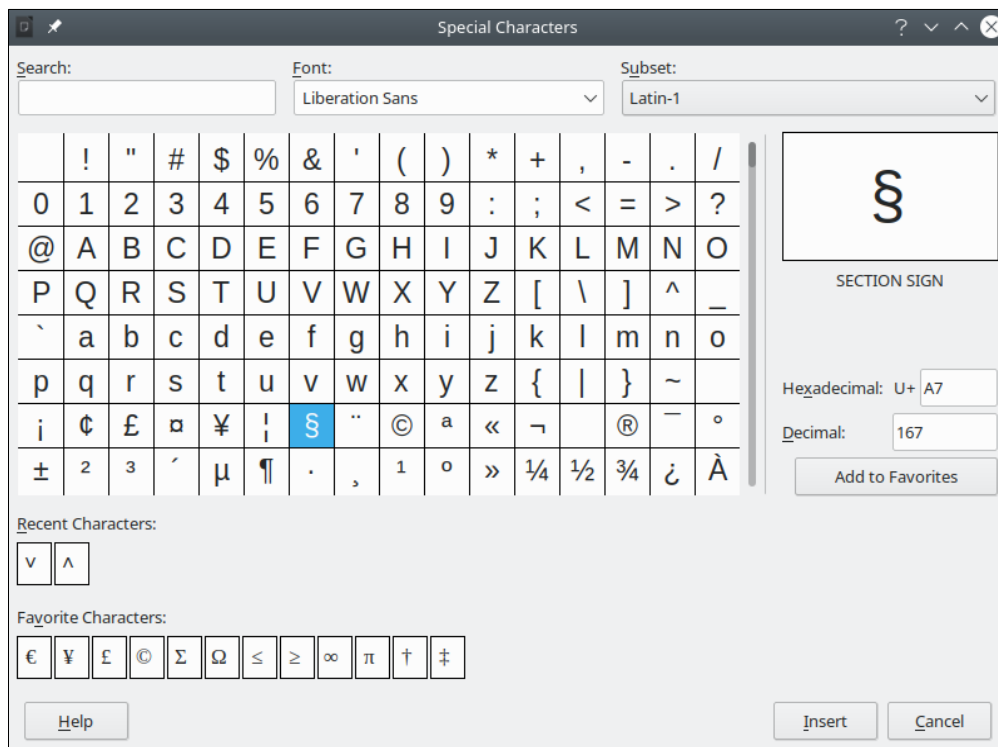

Figure 33: The Special Characters dialog

Inserting non-breaking spaces and hyphens

Non-breaking spaces

To prevent two words from being separated at the end of a line, press *Ctrl+Shift* when you type the space between the two words. This inserts a non-breaking space. You can also use **Insert > Formatting Mark > Insert non-breaking space** on the Menu bar.

Non-breaking hyphens

In cases where you do not want the hyphen to appear at the end of a line, for example in a number such as 123-4567, you can press *Ctrl+Shift+minus sign* or use **Insert > Formatting Mark > Insert non-breaking hyphen**.

Inserting en and em dashes

To enter en and em dashes as you type, you can use **Replace dashes** on the *Options* tab in the AutoCorrect dialog (**Tools > AutoCorrect > AutoCorrect Options**). This option replaces one or two hyphens, under certain conditions, with the corresponding dash. See the Help or the *Writer Guide* for more details and other methods of inserting dashes.

- An en-dash is a dash the width of the letter “n” in the font you are using. Type at least one character, a space, a hyphen, another space, and at least one more letter. The hyphen will be replaced by an en-dash.
- An em-dash is a dash the width of the letter “m” in the font you are using. Type at least one character, two hyphens, and at least one more character. The two hyphens will be replaced by an em-dash. Exception: if the characters are numbers, as in a date or time range, the two hyphens are replaced by an en-dash.

Checking spelling and grammar

By default, four dictionaries are installed for each language, if they are available for that language: a spelling checker, a grammar checker, a hyphenation dictionary, and a thesaurus. The spelling checker determines if each word in the document is in the installed dictionary. The grammar checker works in combination with the spelling checker. You can choose to check spelling and grammar automatically as you type, or at any other time, or both.

Checking spelling and grammar automatically

When **Automatic Spell Checking** is selected in the Tools menu, Standard toolbar, or Options dialog, each word is checked as it is typed and a wavy red line appears under any unrecognized words. If **Check grammar as you type** has also been enabled, errors are marked with a wavy blue underline. See “Checking grammar” on page 77.

At any time, you can right-click on an unrecognized word to open a context menu (Figure 34), where you can choose one of the suggested words to replace it. When the word is corrected, the line disappears. If the word is correct but not in the dictionary, you can choose **Add to dictionary**. If the list does not contain the word you want, click **Spelling** to open the Spelling dialog (Figure 35).

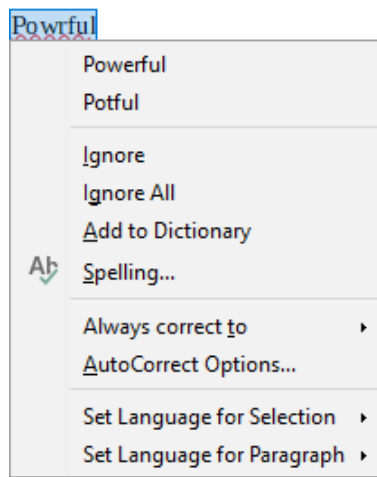

Figure 34: Spelling context menu

Using the Spelling dialog

In addition to automatic checking, or in place of it, you can perform a combined spelling and grammar check on the document (or a text selection). Click the **Check Spelling** button on the Standard toolbar, or choose **Tools > Spelling**, or press *F7* on the keyboard. This checks the document or selection and opens the Spelling dialog if any unrecognized words are found. To also identify potential grammar problems, select the **Check grammar** checkbox.

Here are some more features of the spelling checker:

Text language

The language to be used for checking spelling can be selected in this drop-down list.

Add a word to the dictionary

Add a word to the dictionary by clicking **Add to Dictionary** in the Spelling dialog or in the context menu. The word will be added to the Standard dictionary, unless you have created another dictionary in the same language. If you have created a new dictionary, you will be given a choice of dictionaries to add the word to.

Choose text for spell checking

Choose whether to check uppercase words or words that contain numbers, by clicking the **Options** button on the Spelling dialog to open a dialog similar to the one in **Tools > Options > Languages and Locales > Writing Aids**, described in Chapter 12, *Configuring LibreOffice*.

Manage custom dictionaries

Create, edit, or delete dictionaries and edit words in the dictionary in the same Options dialog.

Specify language for specific paragraphs

Set paragraphs to be checked in a language (different from the rest of the document) using several methods—for example, by clicking on the *Text Language* field on the Status Bar or by creating paragraph styles for specific languages. See “Using built-in language tools” on page 93 or refer to the *Writer Guide* for more information.

See the *Writer Guide* for more information about the spelling and grammar checking options.

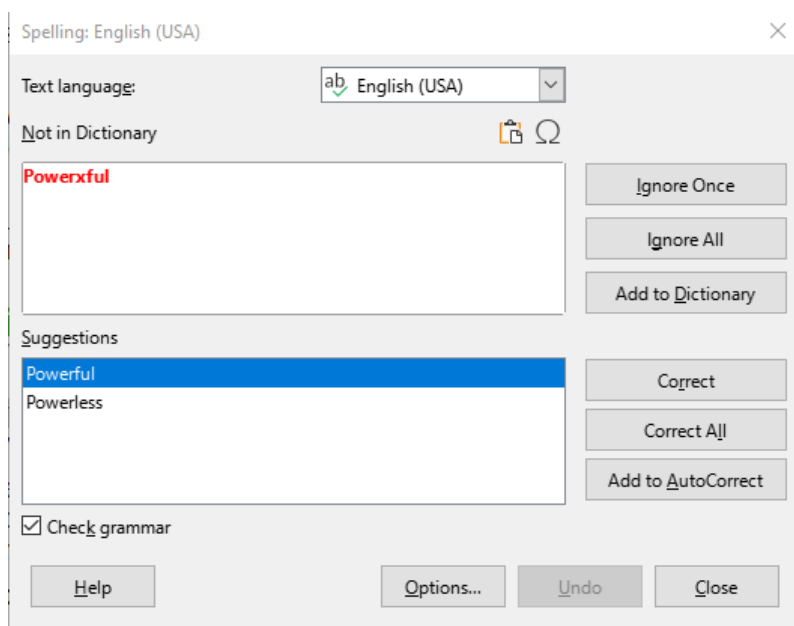

Figure 35: Spelling dialog

Checking grammar

If any grammar errors are detected, they are shown underlined by a wavy blue line. Right-click on this line to open a context menu.

The first entry in the context menu describes the suspected broken grammatical rule.

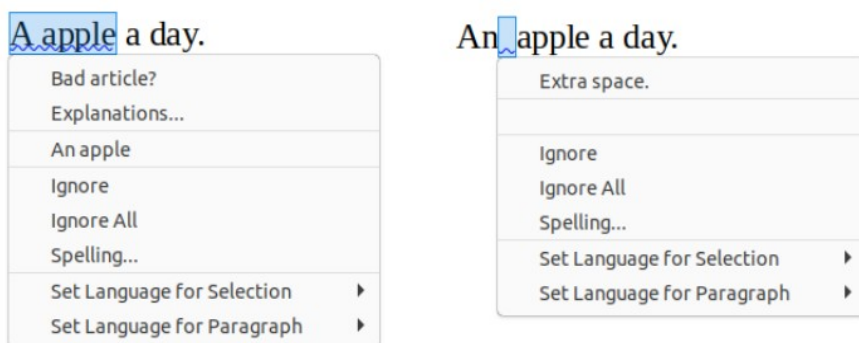

Figure 36: Context menu for grammar errors

The second menu item may be **Explanations**, which opens your browser to a web page offering more information about the error. Next may be the suggested correction. Clicking this changes the text to the suggestion.

In the third section of the context menu, you can choose to ignore the indicated error, or open the Spelling dialog (Figure 35). In the final section of the menu, you can set the language for the selection or the paragraph.

You can select additional grammar checking rules through **Tools > Options > Languages and Locales > English Sentence Checking**, or add remote LanguageTool grammar checking through **Tools > Options > Languages and Locales > LanguageTool Server**. See Chapter 12, Configuring LibreOffice, for details.

Using synonyms and the thesaurus

To access a short list of synonyms, right-click on a word and point to **Synonyms** in the context menu. A submenu of alternative words and phrases is displayed. Click on a word or phrase in the submenu to have it replace the highlighted word or phrase in the document.

The thesaurus gives a more extensive list of alternative words and phrases. To use the thesaurus, click on **Thesaurus** in the **Synonyms** submenu. If the current language does not have a thesaurus installed, this feature is disabled.

Using AutoCorrect

Writer's AutoCorrect function has a long list of common misspellings and typing errors, which it corrects automatically. It also includes codes for inserting special characters, emoji, and other symbols.

AutoCorrect is turned on by default. You may wish to disable some of its features, modify others, or turn it off completely. To turn AutoCorrect off, uncheck **Tools > AutoCorrect > While Typing**.

You can add your own corrections or special characters or change those supplied with LibreOffice. Choose **Tools > AutoCorrect > AutoCorrect Options** to open the AutoCorrect dialog. On the *Replace* tab, you can define which strings of text are corrected and how. In most cases, the defaults are fine.

To stop Writer replacing a specific spelling, go to the *Replace* tab, highlight the word pair, and click **Delete**. To add a new spelling to the list, type it into the *Replace* and *With* boxes on the *Replace* tab, and click **New**.

See the different tabs of the dialog for the other options available to fine-tune AutoCorrect.

Tip

LibreOffice has an extensive list of special characters accessible with AutoCorrect. For example, type `:smiling:` and AutoCorrect will replace it with ☺. Or, `(c)` will be changed to ©. You can add your own special characters.

Using Word Completion

If Word Completion is enabled, Writer tries to guess which word you are typing and offers to complete the word for you. To accept the suggestion, press *Enter*. Otherwise, continue typing.

To turn off Word Completion, select **Tools > AutoCorrect > AutoCorrect Options** and deselect **Enable word completion** on the *Word Completion* tab.

Options for customizing word completion from the AutoCorrect dialog include:

- Add (append) a space automatically after an accepted word.
- Show the suggested word as a tip (hovering over the word) rather than completing the text as you type.
- As you add words when working on documents, you can either save them for later use in other documents or select the option to remove them from the list when closing documents.
- Change the maximum number of words remembered for word completion and the length of the smallest words to be remembered.
- Delete specific entries from the word completion list.
- Change the key that accepts a suggested entry—the options are right arrow, End key, Return (Enter), Space bar, and Tab.

Note

Automatic word completion only occurs after you type a word for the second time in a document.

Using AutoText

Use AutoText to store text, tables, fields, and other items for reuse and assign them to a key combination for easy retrieval. For example, rather than typing “Senior Management” every time you use that phrase, you can set up an AutoText entry to insert those words when you type “sm” and press *F3*.

To store some text as AutoText:

- 1) Type the text into your document, then select the text.
- 2) Choose **Tools > AutoText** on the Menu bar (or press *Ctrl+F3*).
- 3) In the AutoText dialog (Figure 37), type a name for the AutoText in the *Name* box. Writer will suggest a one-letter shortcut, which you can change.

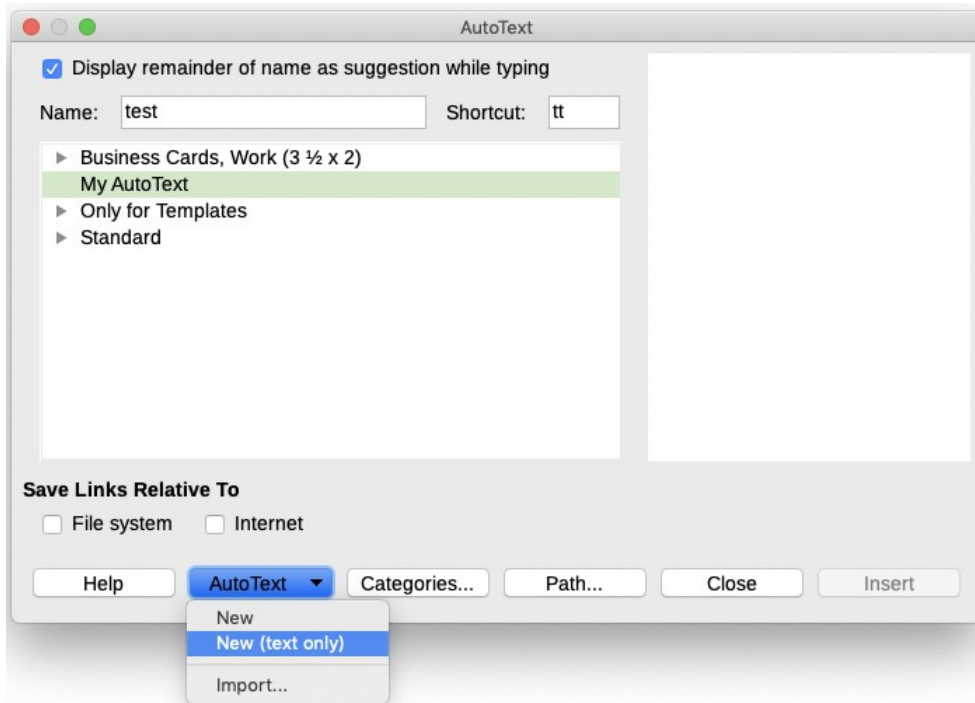

Figure 37: Creating an AutoText entry

- 4) Choose the category for the AutoText entry, for example *My AutoText*.
- 5) Click the **AutoText** button at the bottom of the dialog and select in the menu either **New**, to have the AutoText retain specific formatting, no matter where it is inserted, or **New (text only)**, to have the AutoText take on the existing formatting around the insertion point.
- 6) Click **Close** to return to your document.

To insert AutoText, type the shortcut and press *F3*.

Tip

If the only option under the AutoText button is **Import**, either you have not entered a name for your AutoText or there is no text selected in the document.

AutoText is especially powerful when assigned to fields. See the *Writer Guide* for more information.

Changing the case of selected text

To quickly change the case of text, select it, choose **Format > Text** on the Menu bar, and then choose one of the items on the submenu. The most common are:

- **UPPERCASE**, where all letters are capitalized.
- **lowercase**, where no words (except proper nouns) are capitalized.
- **Sentence case**, where only the first word is capitalized (together with any proper nouns).
- **Capitalize Every Word**, where every word is capitalized.
- **Small capitals**, which capitalizes all letters in a reduced font size.

Writer does not have an automated way to do **Title Case**, where all words are capitalized except for certain subsets defined by rules that are not universally standardized. However, you can use *Capitalize Every Word* and then restore those words that you do not want capitalized.

Formatting text

You can format text in two ways. See the *Writer Guide* for details.

Direct (or Manual) formatting

Applies formatting directly to specific paragraphs, characters, pages, frames, lists, or tables. For example, you can select a word, then click on a button on the Formatting toolbar to format the text as bold or italics.

Styles

Bundles formatting options. For example, a paragraph style defines numerous settings for options such as font type and size, whether paragraphs should be indented, the space between lines, how paragraphs should be aligned on the page, and many others.

Using styles is highly recommended

Writer is a style-based program. Because styles apply whole groups of formats at the same time, you can easily format a document consistently and change the formatting of an entire document with minimal effort. In addition, LibreOffice uses styles for many processes, even if you are not aware of them. For example, Writer relies on heading styles (or other styles you specify) when it compiles a table of contents.

Writer defines six types of styles: paragraph, character, frame, page, list, and table. See Chapter 4, *Working with Styles, Templates and Hyperlinks*, in this book and also refer to the *Writer Guide*.

Formatting paragraphs using styles

Styles can be applied to paragraphs in several ways:

- Styles drop-down selection list at the left end of the Formatting toolbar
- Styles deck of the Sidebar
- **Styles** menu on the Menu bar (limited to common styles)
- Keyboard shortcuts *Ctrl+1* to *Ctrl+5* (paragraph styles Heading 1 to Heading 5)

You can also open a Formatting (Styles) toolbar using **View > Toolbars > Formatting (Styles)**; see Figure 38.



Figure 38: Formatting (Styles) toolbar

Formatting paragraphs directly

You can manually apply many direct formats to paragraphs using the buttons on the Formatting toolbar and by using the Paragraph panel of the Sidebar's Properties deck. Not all buttons are visible in a standard installation, but you can customize the toolbar to include those you use regularly. These buttons and formats include:

- Set Paragraph Style
- Toggle Unordered List (with a palette of bullet styles)
- Toggle Ordered List (with a palette of numbering styles)
- Align Left, Align Center, Align Right, Justified
- Align Top, Center Vertically, Align Bottom
- Line Spacing (choose from 1, 1.15, 1.5, 2, or custom spacing)
- Increase Paragraph Spacing, Decrease Paragraph Spacing
- Increase Indent, Decrease Indent, Hanging Indent
- Paragraph (to open the Paragraph dialog)
- Set Line Spacing

Note

Direct formatting (also called manual formatting) overrides styles. This means that when a new style is applied, direct formatting is not removed and still determines the displayed format.

Removing direct formatting

To remove direct formatting, select the text and choose **Format > Clear Direct Formatting** on the Menu bar, or right-click and choose **Clear Direct Formatting** in the context menu, or press **Ctrl+M** on the keyboard, or select the **Clear Direct Formatting** icon on the Formatting toolbar.

Note

When clearing direct formatting, the text formatting will return to the applied paragraph and character style and not the default paragraph style or default character style (unless these styles are actually applied to the text).

Formatting characters using styles

To apply a character style, highlight the characters or words and apply the selected character style from the *Character Styles* tab of the Styles deck on the Sidebar, in the Styles menu on the Menu bar (limited), or from the right-click context menu (limited).

Formatting characters directly

It is recommended that you use styles to format characters as much as possible rather than formatting characters directly, as described in this section.

You can directly apply many formats to characters using the buttons on the Formatting toolbar and by using the Character panel of the Sidebar's Properties deck. Not all buttons are visible in a standard installation, but you can customize the toolbar to include those you use regularly. These buttons and formats include:

- Font Name, Font Size
- Bold, Italic, Underline, Overline, Strikethrough, Outline Font Effect, Shadow
- Superscript, Subscript
- Uppercase, Lowercase
- Increase Font Size, Decrease Font Size
- Font Color (with a palette of colors)
- Background Color (with a palette of colors)
- Character Highlighting Color (with a palette of colors)

Note

Just as direct paragraph formatting overrides the current paragraph style, applying direct character formatting to characters overrides the current character style formatting.

Formatting tables

Tables in a Writer document share the same sets of formatting elements as spreadsheets in LibreOffice Calc. You can format tables manually or using table styles. Writer has predefined table styles and you can also define your own using the AutoFormat Styles dialog.

To apply a table style, click in the table to be formatted and double-click on a style listed in the *Table Styles* tab of the Sidebar's Styles deck. Alternatively, click in the table to be formatted, choose **Table > AutoFormat Styles** on the Menu bar and select a style from the dialog that opens. For more information, refer to the *Writer Guide*.

Autoformatting

You can set Writer to format or correct parts of a document automatically as you type, according to the choices made on the *Options* and *Localized Options* tabs of the AutoCorrect dialog (**Tools > AutoCorrect > AutoCorrect Options**).

Autoformatting on the *Options* tab includes URL recognition, bulleted and numbered lists, capitalizing the first letter of every sentence, and correcting two initial capitals on words.

A bulleted (unordered) list is created when you type a hyphen (-), star (*), or plus sign (+), followed by a space or tab at the beginning of a paragraph. A numbered (ordered) list is created when you type a number followed by a period (.), followed by a space or tab at the beginning of a paragraph.

The *Localized Options* tab controls the formatting of quotation marks and apostrophes (which look like a closing single quote). Most fonts include curly quotation marks (also known as "smart quotes"), but for some purposes (such as marking minutes and seconds of latitude and longitude) you may wish to format them as straight quotes.

Straight quotes
' ' " "

Smart quotes
' ' " "

Tip

If you notice unexpected formatting changes occurring in your document, this is the first place to look for the cause. In most cases **Edit > Undo** (*Ctrl+Z*) fixes the issue.

Creating lists with styles

For more about creating lists using styles, see the *Writer Guide*.

Creating unordered (bulleted) and ordered (numbered) lists

Whenever possible, use paragraph styles for creating unordered (bulleted) and ordered (numbered) lists. Writer comes with two sets of paragraph styles for this purpose.

However, these styles do not include options for settings such as the type of bullet or position of numbers. Those settings come from list styles, which are a different type of style. Writer's separate list styles have two major advantages: the same list style can be used with multiple paragraph styles, and a paragraph's associated list style can be changed with a single selection.

It is recommended to use paragraph and list styles together in these ways:

- Use paragraph styles List 1, List 2, List 3, and so on for creating unordered lists. Use any of the Bullet list styles with these paragraph styles.
- Use paragraph styles Numbering 1, Numbering 2, Numbering 3, etc, for creating ordered lists. Use any of the Numbering list styles with these paragraph styles.

You can use the predefined paragraph and list styles or define your own.

To assign a list style to a paragraph style, go to the Styles deck in the Sidebar, right-click on the paragraph style you want to use, then choose **Edit Style**. On the *Outline & List* tab on the Paragraph Style dialog, in the *List style* drop-down list, choose the required list style (Figure 39).

Paragraph styles such as List 1 Start and List 1 End enable you to adjust specific properties (such as the space between paragraphs) for items at the beginning or end of the list.

Note

List styles are not meant to be used on their own. Rather, they are designed to be attached to paragraph styles.

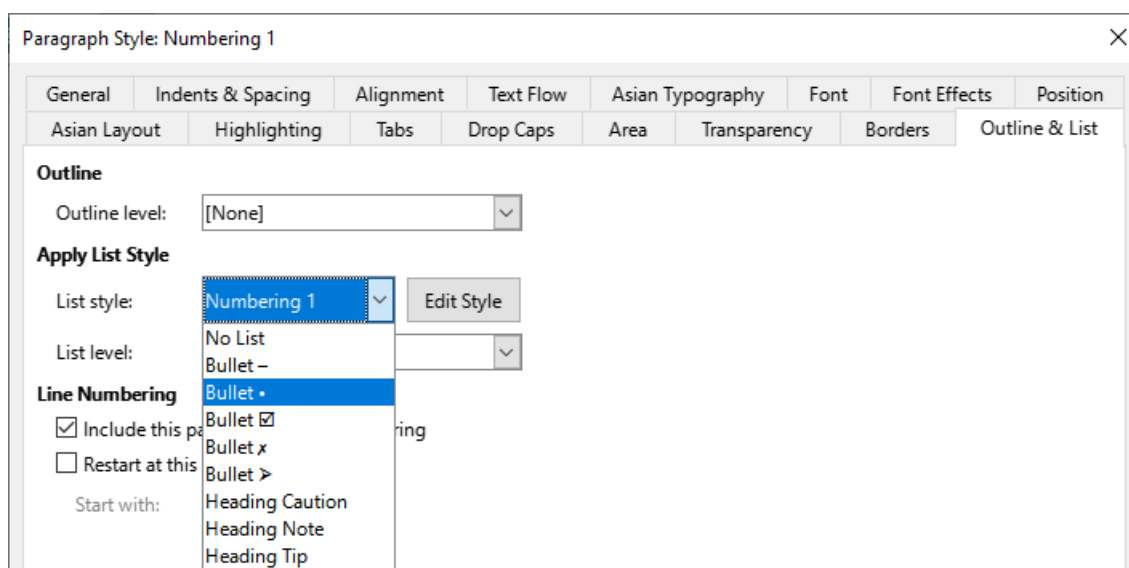

Figure 39: Assigning a list style to a paragraph style

Creating nested lists using styles

With paragraph styles, you can easily create nested lists, in which list items have sub-items under them, as in an outline. This requires specifying the settings for the additional levels. To do this, right-click on the list style (not the paragraph style) in the Styles deck on the Sidebar, select **Edit Style**, and specify how each level will be labeled, using the *Customize* tab. Also specify the position and spacing for each level on the *Position* tab. Refer to the *Writer Guide* for details.

Once you have set up nested lists, you can readily change the hierarchy of an item. To demote an item one level, position the cursor at the beginning of the line (after the bullet or number) and press the *Tab* key. To promote an item one level, press *Shift+Tab*.

Creating lists with direct formatting

Creating unordered and ordered lists

Bullets and numbers can be manually applied in three ways:

- Use AutoCorrect to autoformat text, as described above
- Use the **Toggle Unordered List** and **Toggle Ordered List** buttons on the Formatting toolbar
- Use the Paragraph panel of the Sidebar's Properties deck

Bullets and numbering can be applied to already selected text or they can be applied as you type.

Tip

Bullets and numbering applied in these ways cannot be removed with **Format > Clear Direct Formatting** on the Menu bar, or with the **Clear Direct Formatting** icon on the Formatting toolbar, or by using *Ctrl+M*. Rather, they are turned off or removed from selected text by toggling the relevant buttons on the Formatting toolbar, or on the Sidebar's Properties deck.

Creating nested lists

Use the buttons on the Bullets and Numbering toolbar to move items up or down the list, create sub-items, change the style of bullets, and access the Bullets and Numbering dialog, which contains more detailed controls. Use **View > Toolbars > Bullets and Numbering** to see the toolbar.

Tip

If numbering or bullets are being applied automatically in a way that you do not want, you can disable them by going to **Tools > AutoCorrect > AutoCorrect Options** and deselecting **Bulleted and Numbered List** on the Options tab.

The **Toggle Unordered List** and **Toggle Ordered List** buttons on the Sidebar's Properties deck can also be used to create nested lists. Click the down arrow next to the relevant button, then click **More Bullets/Numbering** to access the Bullets and Numbering dialog. However, the Sidebar does not include tools for promoting and demoting items in the list, as found on the Bullets and Numbering toolbar.

Setting tab stops and indents

The horizontal ruler shows the tab stops. Any tab stops that you have defined will overwrite the default tab stops. Tab settings affect indentation of full paragraphs (using the **Increase Indent**

and **Decrease Indent** buttons on the Formatting toolbar) as well as indentation of parts of a paragraph (by pressing the *Tab* key on the keyboard).

Using the default tab spacing can cause formatting problems if you share documents with other people. If you use the default tab spacing and then send the document to someone else who has chosen a different default tab spacing, tabbed material will change to use the other person's settings. Instead of using the defaults, define your own tab settings, as described in this section.

To define indents and tab settings for one or more selected paragraphs, right-click and choose **Paragraph > Paragraph**. On the Paragraph dialog, go to the *Tabs* tab.

A better strategy is to define tabs for the paragraph style. This is done on the *Tabs* tab of the Paragraph Style dialog.

Tip

Using tabs to space out material on a page is not recommended. Depending on what you are trying to accomplish, a table or frame might be a better choice.

Changing the default tab stop interval

Caution

Any changes to the default tab setting will affect the existing default tab stops in any document you open afterward, as well as tab stops you insert after making the change.

To set the spacing of default tab stop intervals, go to **Tools > Options > LibreOffice Writer > General**.

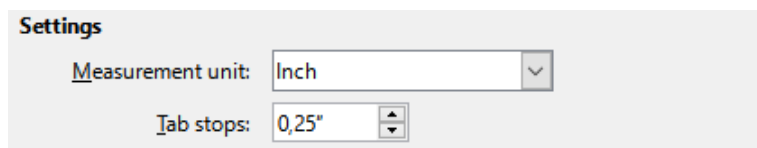

Figure 40: Selecting a default tab stop interval

Changing measurement units for tab stops and rulers

Change the measurement unit for rulers in the current document by right-clicking on the ruler to open a list of units. Click on one of them to change the ruler to that unit. The selected setting applies only to that ruler.

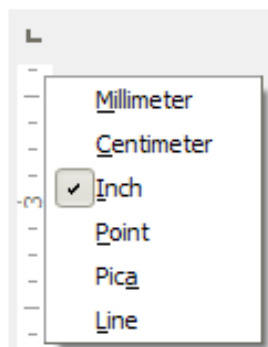

Figure 41: Changing the measurement unit for a ruler

Hyphenating words

You can hyphenate words at the end of a line in two ways: let Writer do it automatically (using styles and its hyphenation dictionaries), or insert soft hyphens manually where needed. Or, you can choose to not hyphenate at all.

Automatic hyphenation using styles

To turn automatic hyphenation of words on or off:

- 1) On the Styles deck on the Sidebar, go to Paragraph Styles, right-click on Default Paragraph Style (or another style you want to use) and select **Edit Style**.
- 2) On the Paragraph Style dialog (Figure 42), go to the *Text Flow* tab.
- 3) Under *Hyphenation*, select or deselect **Automatically**. When automatic hyphenation is on, you can also set the criteria for when it should occur. Click **OK** to save.

Note

Turning on hyphenation for the Default Paragraph Style affects all other paragraph styles that are based on Default Paragraph Style. You can individually change other styles so that hyphenation is not active; for example, you might not want headings to be hyphenated.

Any styles not based on Default Paragraph Style are not affected. See Chapter 4, Working with Styles, Templates, and Hyperlinks, for more about styles based on styles other than Default Paragraph Style.

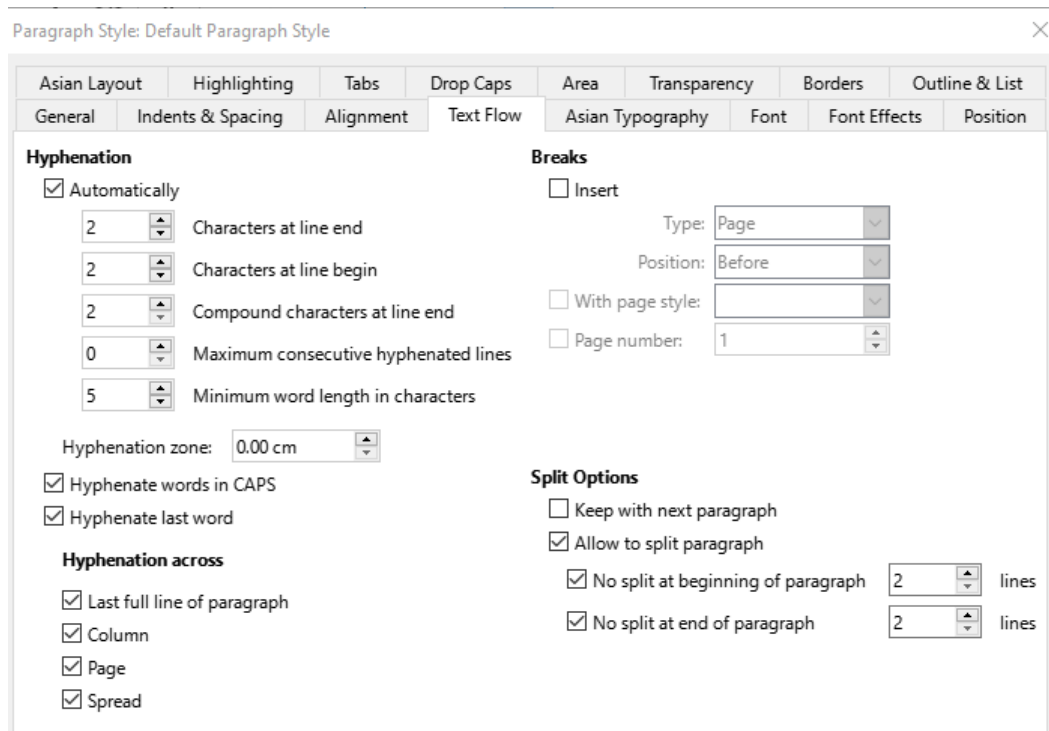

Figure 42: Turning on automatic hyphenation in a paragraph style

Setting hyphenation with Writing Aids

You can also set hyphenation options through **Tools > Options > Languages and Locales > Writing Aids**. These choices apply when there is no specific setting in a paragraph style.

In *Options*, near the bottom of the dialog, scroll down to find the hyphenation settings.

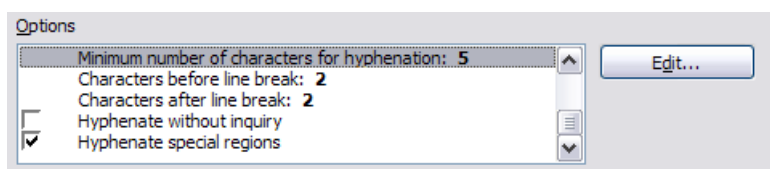

Figure 43: Setting hyphenation options

To change the minimum number of characters for hyphenation, or the minimum number of characters before or after a line break, select the item, and then click the **Edit** button in the *Options* section.

Note

Hyphenation options set in Writing Aids are effective only if hyphenation is turned on through paragraph styles.

Manual hyphenation

Manually hyphenate words when you want only a specific word hyphenated at the end of a line. Do *not* use a normal hyphen, which will remain visible even if the word is no longer at the end of a line when you add or delete text, or change margins or font size. Instead, use a soft hyphen, which is visible only when required.

To insert a soft hyphen inside a word, click where you want the hyphen to appear (when needed) and press *Ctrl+hyphen* or use **Insert > Formatting Mark > Soft Hyphen**. When the word is at the end of the line it will be hyphenated at this position, even if automatic hyphenation for this paragraph is switched off.

Formatting pages

Every page in Writer is based on a page style. Page styles define basic layout, including page size, margins, headers and footers, borders, backgrounds, and so on. Changes to these settings automatically change the page style. This means that, in contrast to paragraph styles, these settings cannot be used to directly format individual pages.

As with other styles, Writer comes with a number of page styles. You can modify these styles or create new ones. The Default Page Style is used when no other page style has been specified.

In addition to page styles, several features enable you to further control page layouts, including columns, frames, tables, and sections. For more information, see the *Writer Guide*.

Tip

Page layout is usually easier if you show text, object, table, and section boundaries in **Tools > Options > LibreOffice > Application Colors**, and paragraph ends, tabs, breaks, and other items in **Tools > Options > LibreOffice Writer > Formatting Aids**.

Creating headers and footers

A header is an area that appears at the top of a page above the margin. A footer appears at the bottom of the page below the margin. Information such as a page number is placed in the header or footer of a page style. That information is then displayed on every page with the same page style (unless the page style specifies separate settings for the first page or for left and right pages).

Inserting a header or footer

You can insert a header in several ways. Here is the easiest:

- Click above the top margin (or below the bottom margin) to make the Header or Footer marker appear (Figure 44), and then click on the + sign.

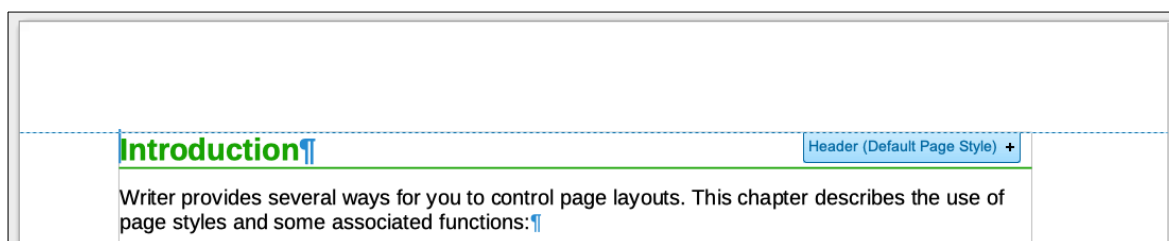

Figure 44: Header marker at top of text area

After a header/footer has been created, a down-arrow appears on the marker. Click on this arrow to drop down a menu of choices for working with the header (Figure 45).

Alternatively, you can choose **Insert > Header and Footer > Header > Default Page Style** (or some other page style, if not Default Page Style).

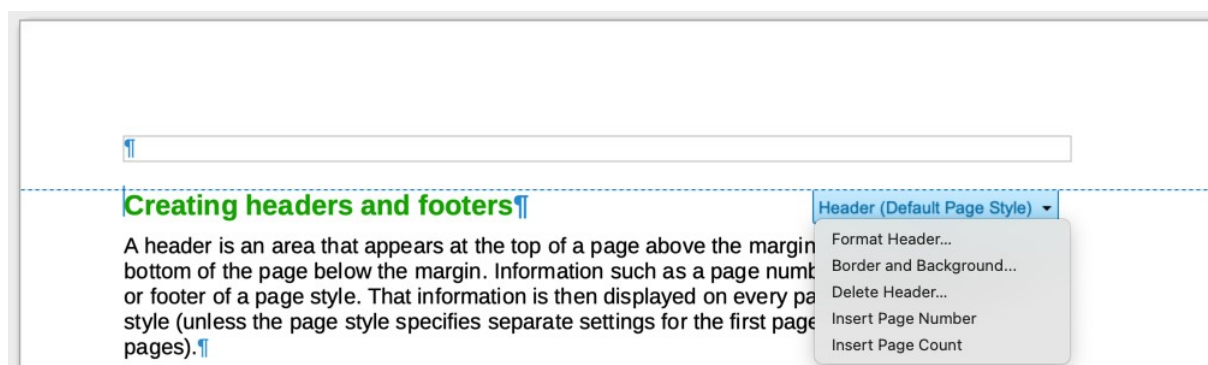

Figure 45: Header menu

Displaying different headers on right and left pages

Page styles can be set up to have the facing left and right pages mirrored or only right (first pages of chapters are often defined to be right-page only) or only left. When you insert a header on a page style set up for mirrored pages or right-and-left pages, you can have the contents of the header be the same on all pages or be different on the right and left pages. For example, you can put the page number on the left-hand edge of the left pages and on the right-hand edge of the right pages, put the document title on the right-hand page only, or make other changes.

Determining header and footer appearance

To format a header (use similar settings for a footer), you can either click on **Format Header** in the menu shown in Figure 45 or go to **Format > Page Style, Header** tab. Both methods take you to the same tab on the Page Style dialog.

Here you can specify if headings on the left and right pages should be the same or different. You can also specify whether the first page will have no header or a different header than other pages.

In this dialog, you can also turn the header on or off, set the margins, and set the spacing between the header and document text.

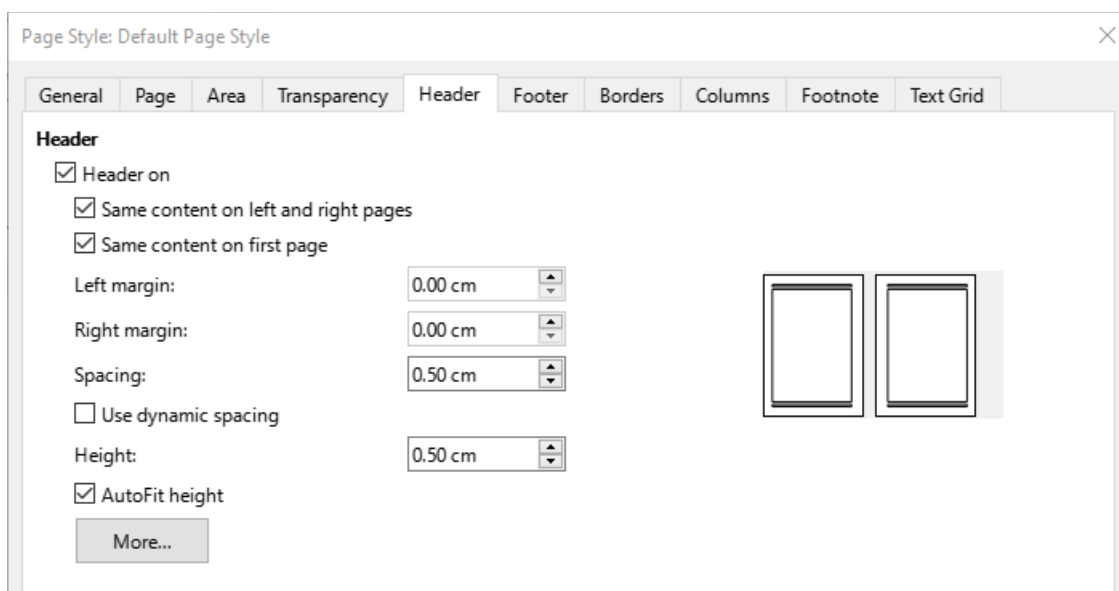

Figure 46: Page Style dialog, Header tab

Inserting document title in headers and footers

Information such as a document title is often put into the header or footer. These items are best added as fields. That way, if something (such as the name) changes, the headers and footers are updated automatically. Here is one common way to use fields to insert the document title into the header:

- 1) Choose **File > Properties**. On the *Description* tab, type a title for your document, and click the **OK** button.
- 2) Place the cursor in the header area at the top of the page.
- 3) Choose **Insert > Field > Title**. The title may appear on a gray background. The background does not show when printed and can be turned off in **Tools > Options > LibreOffice > Application Colors**.

For more about headers, footers, and fields, see the *Writer Guide*.

Numbering pages

Displaying the page number

To display page numbers automatically:

- 1) Insert a header or footer as described in “Creating headers and footers” on page 87.
- 2) Place the cursor in the header or footer where you want the page number to appear and choose **Insert > Page Number**.
- 3) Change the alignment of the number if you wish (left, right, or center).

Including the total number of pages

To include the total number of pages (as in “page 1 of 12”):

- 1) Type the word “page” and a space, then insert the page number as above.
- 2) Press the space bar once, type the word “of” and a space, then choose **Insert > Field > Page Count**.

 **Note**

The Page Count field inserts the total number of pages in the document, as shown on the *Statistics* tab of the document's Properties dialog (**File > Properties**). If you restart page numbering anywhere in the document, then the total page count may not be what you want. See the *Writer Guide* for more information.

Restarting page numbering

Often you will want to restart the page numbering at 1, for example on the page following a title page or a table of contents. In addition, many documents have the “front matter” (such as the table of contents) numbered with Roman numerals and the main body of the document numbered in Arabic numerals, starting with 1. To restart page numbering:

Place the cursor in the first paragraph of the new page.

- 1) Choose **Format > Paragraph**.
- 2) On the *Text Flow* tab of the Paragraph dialog (Figure 42 on page 86), select **Insert** in the *Breaks* area, and then select **With page style** and specify the page style to use.
- 3) Specify the page number to start from, and then click **OK**.

 **Tip**

This is also useful for numbering the first page of a document with a page number greater than 1.

Line numbering

Line numbers in the margin are often used in legal documents, poetry, and lists of programming code. Writer can insert line numbers in an entire document or for selected paragraphs. Line numbers are included when you print the document.

You can choose how many lines are numbered (for example, every line or every tenth line), the numbering type, and whether numbers restart on each page.

To add line numbers to a document, choose **Tools > Line Numbering** and select the **Show numbering** option in the top left corner of the Line Numbering dialog. Then select any options you want and click **OK**.

You can also create a paragraph style that includes line numbering, and apply it to the paragraphs that you want to add line numbers to. For example, to number the lines of example code in a document, you will probably want to use a font or indentation that is different from normal text.

Changing page margins

You can change page margins in three ways:

- Using the page rulers — quick and easy, but does not allow fine control.
- Using the Page Style dialog — you can specify margins with precision of up to two decimal places.
- Using the Page deck of the Sidebar.

 **Caution**

When you change the margins, the page style is also changed and the changed margins apply to all pages using that style.

To change margins using the rulers:

- 1) The gray sections of the rulers are the margins. Put the mouse pointer over the line between the gray and white sections. The pointer turns into a double-headed arrow and displays the current setting in a tool-tip.
- 2) Hold down the left mouse button and drag the mouse to move the margin.

Caution

The two small gray triangles on the ruler are used for indenting paragraphs. The double-headed arrows shown in Figure 47 are mouse pointers shown in the correct position for moving the margin markers. Because the triangles and arrows are often in the same place, when changing page margins you need to be careful to move the arrows, not the gray triangles.

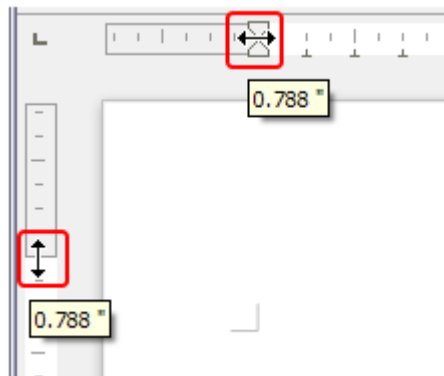

Figure 47: Moving the margins

To change margins using the Page Style dialog:

- 1) Right-click anywhere in the text area on the page and select **Page Style** in the context menu.
- 2) On the *Page* tab of the dialog, type the required distances in the boxes in the *Margins* area.

To change margins using the Page deck of the Sidebar:

- 1) On the Sidebar, open the Page deck.
- 2) On the *Format* panel, use the *Margins* drop-down list to select the desired margins from the defaults provided. Click the **More Options** button to open the Page Style dialog where you can enter exact margin distances.

Note

The margin selections on the Sidebar change all four margins to be the same. If you require different margins, you need to use the Page Style dialog.

Choosing a page background

You can apply backgrounds to many elements in Writer, including pages. On the *Area* tab of the Page Style dialog, choose a background type (color, gradient, bitmap, pattern, or hatch). On the *Page* tab of the dialog, you can choose whether the background covers only the text area (the area inside the margins) or the entire page. For more about backgrounds, see the *Writer Guide*.

Adding a custom watermark to the page background

To add a watermark to a page background:

- 1) Choose **Format > Watermark**.
- 2) In the Watermark dialog (Figure 48), type the text and select the font, angle, transparency and color of the watermark. Then click **OK**.

Note

The watermark will automatically become part of the page style where it is inserted and all other pages of the same style will have the watermark. Pages with different or no watermarks need different Page Styles for those pages.

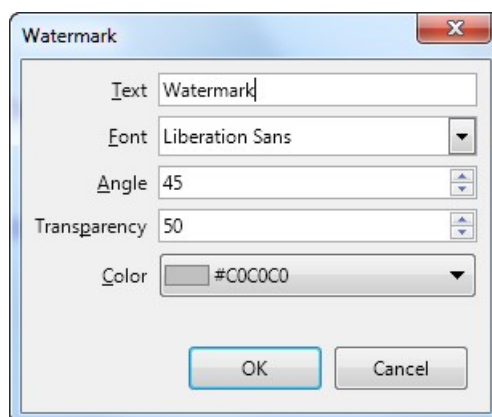

Figure 48: The Watermark dialog

Defining a different first page for a document

Many documents, such as letters and memos, have a first page that is different from the other pages in the document. For example, the first page of a letterhead typically has a different header, or the first page of a report might have no header or footer, while the other pages do.

You can do this in several ways, as described in the Writer Guide:

- Use the Default Page Style (or any other page style) for your document. Deselect the **Same content on first page** option on the Header/Footer tabs in the Page Style dialog, and then add different headers/footers to the first page and to the other pages of the document.
- Use different page styles for the first page and for the following pages. Set the *Next Page* attribute for the first page so the next page automatically becomes the style for following pages.
- Add a title page at the beginning of the document. Writer provides a fast and convenient way to add one or more title pages to a document and optionally to restart the page number at 1 for the body of the document, using **Format > Title Page** on the Menu bar.

Adding comments to a document

Authors and reviewers often use comments to exchange ideas, ask for suggestions, or mark items needing attention.

You can connect a comment to multiple paragraphs or a single point. To insert a comment, select the text, or place the cursor in the place the comment refers to, and choose **Insert > Comment** on the menu bar, click the **Insert Comment** icon on the Standard toolbar, or press

Ctrl+Alt+C. The anchor point of the comment is connected by a dotted line to a box on the right-hand side of the page where you can type the text of the comment. A **Comments** button is also added to the right of the horizontal ruler at the top of the page; you can click this button to toggle the display of the comments.

Formatting comments

At the bottom of the comment, Writer automatically adds the author's name and a time stamp indicating when the comment was created. If more than one person edits the document, each author is automatically allocated a different background color. Figure 49 shows an example of text with comments from two different authors.

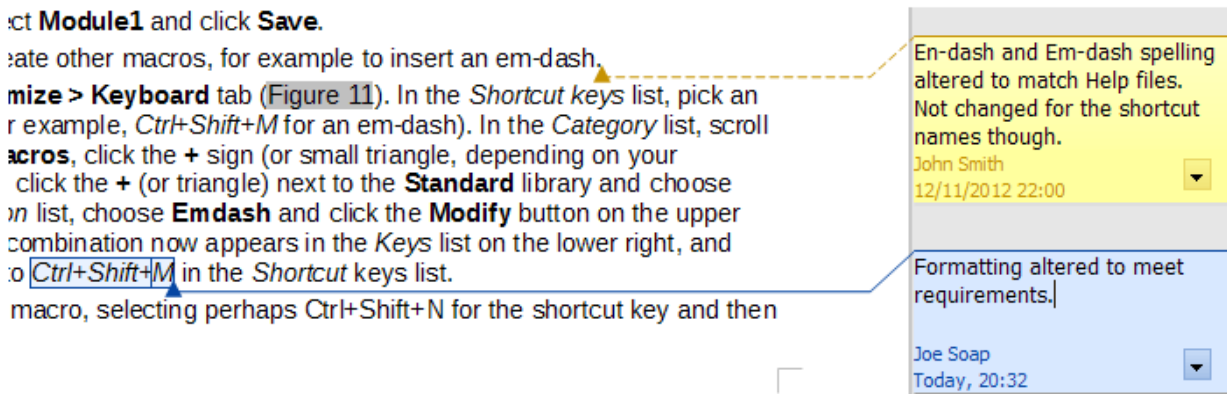

Figure 49: Example of comments

Choose **Tools > Options > LibreOffice > User Data** to provide the name you want to appear in the Author field of comments.

Right-click on a comment to open a context menu where you can delete the current comment or where current comment thread, all the comments from the same author, or all the comments in the document. On this menu, you can also reply to a comment, open a dialog to apply some basic formatting to the text, and mark comments as Resolved. These options are also available on a drop-down menu accessed by clicking the down arrow icon at the bottom right of the comment.

Navigating through comments

To navigate from one comment to another, open the sidebar Navigator, expand the Comments section, and click on the comment text to move the cursor to the anchor point of the comment in the document. Click the comment directly to edit it and right-click on the comment to delete it.

You can also navigate through the comments using the keyboard. Use *Ctrl+Alt+Page Down* to move to the next comment and *Ctrl+Alt+Page Up* to move to the previous comment.

Printing comments

When a document contains comments, the print dialog has an option for comments to be printed next to the text in the right margin, as they appear on the screen. In that case, the text on each page is scaled down to make space for the comments. The Print dialog also has options for placing comments at the end of the page or at the end of the document, or for printing only the comments.

Using built-in language tools

Writer provides some tools that make work easier if you use more than one language in the same document or if you write documents in various languages. Changing the language for

specific text enables you to use the correct dictionaries and rules to check spelling, grammar, and hyphenation. It also applies the localized versions of AutoCorrect replacement options and uses the appropriate thesaurus.

Options for applying languages



Tip

The language used at the location of the cursor is shown in the Status bar, next to the page style in use.

Using styles

Languages can be set on the *Font* tab of the Paragraph Style dialog or the Character Style dialog. See the *Writer Guide* for information on how to manage the language settings of a style.



Caution

Be careful when changing a language in character or paragraph styles, as this will change the language for all characters or paragraphs using that style. It may be useful to include the language in the name of the style.

Languages set with direct formatting will override languages set using styles.

Using direct formatting

The language of a whole document can be set by using **Tools > Options > Languages and Locales > General**. In the *Default Languages for Documents* section, you can choose the language for all the text that is not explicitly marked as a different language.

Set the language for the whole document, for individual paragraphs, or even for individual words and characters, in **Tools > Language** on the Menu bar, and select **For Selection**, **For Paragraph** or **For All Text**. If the required language is not available in the submenu, click **More**. The **Tools > Options > Languages and Locales > General** menu opens, where you can select the language as described above.

Alternatively, you can set the language for individual paragraphs and characters by selecting text or putting the cursor in a paragraph and changing the language on the Status bar. There is also an option **More**, in case the text is not directly available.



Note

Although these methods are a type of direct formatting, they cannot be cleared by using **Format > Clear Direct Formatting** on the Menu bar, clicking the **Clear Direct Formatting** icon on the Formatting toolbar, selecting **Clear Direct Formatting** in the context menu, or using *Ctrl+M*.

Preventing text from being checked for spelling

You can set the language for a paragraph or a group of characters as **None (Do not check spelling)** using any of the methods described above. This option is especially useful for text such as web addresses or programming language snippets that you do not want to check for spelling.

Obtaining resources for additional languages

The spelling checker works only for those languages in the Spelling dialog list that have a dictionary installed. You can install additional dictionaries using **Get more dictionaries online** at the bottom of the **Tools > Language > Writing Aids** dialog.

Creating a table of contents

Writer can generate a table of contents from the headings in your document. Before you start, make sure that the headings are styled consistently. For example, you can use the Heading 1 style for chapter titles and the Heading 2 and Heading 3 styles for chapter subheadings.

Although tables of contents can be customized extensively in Writer, often the default settings are all you need. Creating a quick table of contents is simple:

- 1) When you create your document, use the following paragraph styles for hierarchical heading levels (such as chapter and section headings): Heading 1, Heading 2, Heading 3, and so on. These headings are what will appear in your table of contents.
- 2) Place the cursor where you want the table of contents to appear.
- 3) Choose **Insert > Table of Contents and Index > Table of Contents, Index or Bibliography**.
- 4) Change nothing in the Table of Contents, Index, or Bibliography dialog (unless you want to change the number of levels shown). Click **OK**.

If you add or delete text (so that headings move to different pages) or you add, delete, or change headings, you need to update the table of contents. To do this, right-click anywhere within the table of contents and choose **Update index** in the context menu.

You can define your own heading styles and set them up in **Tools > Heading Numbering**. You can also include other paragraph styles in the table of contents by assigning outline levels to those styles on the Outline & List tab of the paragraph style dialog.

You can customize an existing table of contents at any time. Right-click anywhere in it and choose **Edit Index** in the context menu. The *Writer Guide* describes in detail all the customization options you can choose.

Creating indexes and bibliographies

Indexes and bibliographies work in a similar way to tables of contents. In addition to alphabetical indexes, other types of index supplied with Writer include those for illustrations, tables, and objects.

You can also create a user-defined index. For example, you might want an index containing only the scientific names of species mentioned in the text, and a separate index containing only the common names of species.

Before creating an index, you first need to create index entries in your Writer document. The *Writer Guide* describes how to do this.

Using footnotes and endnotes

Footnotes appear at the bottom of the page on which they are referenced. Endnotes are collected at the end of a document.

To work effectively with footnotes and endnotes, you need to:

- Insert footnotes and define their format.

To insert a footnote or an endnote, put the cursor where you want the footnote or endnote marker to appear. Then select **Insert > Footnote and Endnote** on the Menu bar and choose **Footnote** or **Endnote**, or click the **Insert Footnote** or **Insert Endnote** button on the Standard toolbar.

A footnote or endnote marker is inserted in the text and, depending on your choice, the cursor is relocated either to the footnote area at the bottom of the page or to the endnote area at the end of the document. Type the footnote or endnote content in this area.

To format the footnotes themselves, select **Tools > Footnote/Endnote Settings**. On the Settings of Footnotes and Endnotes dialog, choose settings as required.

See the *Writer Guide* for more details.

- Define the location of footnotes on the page, and the color and line styles for separator lines, if the defaults do not meet your needs. These are found on the *Footnote* tab of the Page Style dialog; see the *Writer Guide*.

Inserting material from other documents

You may wish to reuse material from other files in the document you are writing. For example, you might be writing a set of instructions that include some common paragraphs. You could, of course, retype or copy and paste the common paragraphs into each document. However, if the common paragraphs are edited, you may need to update that information in every document where it occurs.

Writer provides some tools for making these tasks easier. For details, see the *Writer Guide*.

- The Section dialog.
- Two items in the Navigator's drag modes: Insert as Link and Insert as Copy.

Working with images (graphics)

Images in Writer are of these basic types:

- Image files, including photos, drawings, and scanned images
- Diagrams created using LibreOffice's drawing tools
- Artwork created using clip art or Fontwork
- Charts created using LibreOffice's Chart facility

See Chapter 5, *Working with Images and Graphics*, in this book and the *Writer Guide*.

Working with tables

Tables are a useful way to organize and present large amounts of information. In addition to using tables for text or numbers, you could put other objects, such as pictures, in cells. Writer's tables can often be used as an alternative to spreadsheets, and they provide limited spreadsheet functions.

To directly insert a table with the default properties, click the **Insert Table** icon on the Standard toolbar. On the drop-down graphic, choose the size of the table.

To insert a new table using the Insert Table dialog, where you can specify the properties for the table, position the cursor where you want the table to appear, then use any of the following methods to open the dialog:

- Choose **Table > Insert Table** on the Menu bar.

- Press *Ctrl+F12*.
- On the Standard toolbar, click the **Insert Table** icon and select **More Options** at the bottom of the drop-down graphic.

Writer provides many methods to format tables and the contents of cells. Refer to the *Writer Guide*.

Printing and exporting to PDF or EPUB

See Chapter 10, Working with File Formats, Security, and Exporting, in this book and the *Writer Guide* for details on:

- Previewing pages before printing, selecting print options, printing in black and white on a color printer, printing brochures, and other printing features.
- Exporting a Writer document to PDF (Portable Document Format) or EPUB (a popular ebook format).

Using mail merge

Writer provides very useful features to create and print:

- Multiple copies of a document to send to a list of different recipients (form letters)
- Mailing labels
- Envelopes

All these features use data from a registered data source (a spreadsheet or database containing name and address records or other information). The *Writer Guide* describes the merge processes.

Tracking changes to a document

You can use several methods to keep track of changes made to a document. Details are in the *Writer Guide*.

Method 1 (Recommended)

Use Writer's change marks (often called "redlines" or "revision marks") to show added or deleted material or changed formatting. Comments can be recorded to explain the changes; these are handled a bit differently from the comments discussed in "Adding comments to a document" on page 92.

- 1) Open the document and choose **Edit > Track Changes > Record** before starting to edit.
- 2) Later, you or another person can review and accept or reject each change. Choose **Edit > Track Changes > Show**. Right-click on an individual change and choose **Accept Change** or **Reject Change** in the context menu. Alternatively, choose **Edit > Track Changes > Manage** or open the Manage Changes deck on the Sidebar to view the list of changes and accept or reject them. You can also use the icons on the Track Changes toolbar.

Method 2

Make your changes to a copy of the document (stored in a different folder, or under a different name, or both), then use Writer to combine the two files and show the differences. Choose **Edit > Track Changes > Compare Document** or **Edit > Track Changes > Merge Document**.

Method 3

Save versions that are stored as part of the original file. However, this method can cause problems with documents of non-trivial size or complexity, especially if you save a lot of versions.

Note

Not all changes are recorded. For example, changing a tab stop from align left to align right, and changes in formulas (equations) or linked graphics are not recorded.

Tip

In addition to the **Edit > Track Changes** menu, Writer provides the same commands on the Track Changes toolbar (**View > Toolbars > Track Changes**).

Caution

A document with track changes activated but with the changes not shown carries an invisible history of document editing that the current user may not be aware of. Contents deleted or modified can be recovered. While this is a feature, it is also a potential privacy risk.

Using fields

Fields are extremely useful features of Writer. You can use them for data that changes (such as the current date or the total number of pages) and for inserting document properties such as name, author, and date of last update. Fields are the basis of cross-referencing (see below); automatic numbering of figures, tables, headings, and other elements; and a wide range of other functions. See the *Writer Guide* for details.

Linking and cross-referencing within a document

Writer provides three ways to manage references within a document: hyperlinks, cross-references, and bookmarks

- **Hyperlinks:** Refers the user or the document to specific files. A hyperlink can direct the user to a URL that is opened with the default browser or allow the document to open files from a filesystem.
- **Cross-references:** Uses fields to manage the automatic numbering of figures, tables, headings, and other elements; and a wide range of other functions. See the *Writer Guide* for details.
- **Bookmarks:** Allows users to move quickly between different parts of a document. You can cross-reference to bookmarks and create hyperlinks to bookmarks, as described in the *Writer Guide*.

If you save a Writer document to HTML, hyperlinks remain active but cross-references do not. Both remain active when the document is exported to PDF.

Using hyperlinks

See Chapter 4, Working with Styles, Templates, and Hyperlinks, for details on creating hyperlinks within a document and to other documents and websites.

Creating and using cross-references

The *Cross-references* tab of the Fields dialog lists some items, such as headings, bookmarks, figures, tables, or numbered items such as steps in a procedure. You can also create your own reference items; see the *Writer Guide*.

To insert a cross-reference:

- 1) In the document, place the cursor where you want the cross-reference to appear.
- 2) If the Fields dialog is not open, click **Insert > Cross-reference**. On the *Cross-references* tab (Figure 50), in the *Type* list, select the type of item to be referenced (for example, *Headings* or *Figure*).
- 3) Click on the required item in the *Selection* list, which shows all the items of the selected type. You can type some characters in the top box under *Selection* to filter the list in the selection box.

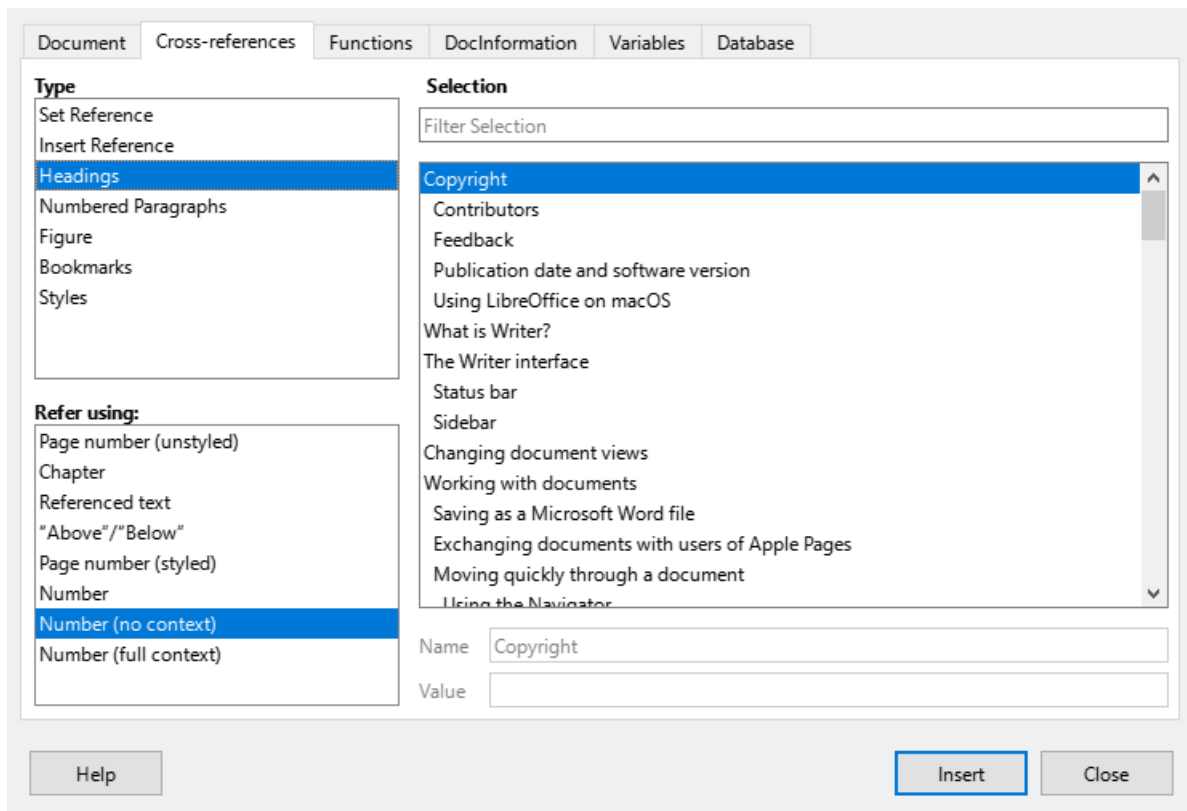

Figure 50: The Cross-references tab of the Fields dialog

- 4) In the *Refer using:* list, select the option needed. The options determine the text inserted for the hyperlink and how it is formatted. The list varies according to the *Type* chosen. The most commonly used options are *Referenced text* (the full text of a heading or caption), *Category and Number* (a figure or table number preceded by the word Figure or Table, but without the caption text), *Number* (the figure or table number, without the word Figure or Table), or *Page number (styled)* (to insert the number of the page the referenced text is on).
- 5) Click **Insert**.

You can leave this dialog open while you insert many cross-references.

Using bookmarks

You can use bookmarks to rapidly navigate or link to specific locations in a document. They are listed in the Navigator and can be accessed directly from there with a single mouse click. You can cross-reference to bookmarks and create hyperlinks to bookmarks, as described above.

To create a bookmark:

- 1) Select the text you want to bookmark. Click **Insert > Bookmark**.
- 2) On the Insert Bookmark dialog, the larger box lists any previously defined bookmarks. Type a name for this new bookmark in the top box, and then click **Insert**.

Text enclosed by a bookmark can be edited in the Bookmark dialog as well as in the document itself. When you edit text in the dialog, it is also edited in the document. If you have change tracking on, the change is tracked in the document.

Using master documents

A master document joins separate text documents into one larger document, and unifies the formatting, table of contents, bibliography, index, and other tables or lists. Master documents are typically used for producing long documents such as a book, thesis, or long report. They are especially handy when different people are writing different sections of a document, eliminating the need to continually share the full document. For details on using master documents, see the *Writer Guide*.

Creating fill-in forms

In a standard text document, such as a report, any text can be edited. By contrast, a form has sections that are not to be edited, and other sections that are designed for the reader to fill in information or make selections. For example, a questionnaire has an introduction and questions (which do not change) and spaces for the reader to enter answers.

Forms are used in three ways:

- To create a simple document for the recipient to complete, such as a questionnaire sent out to a group of people who fill it in and return it.
- To enter information directly into a database or data source. Someone taking orders might enter the information for each order into a database using a form.
- To view information held in a database or data source. A librarian might call up information about books.

Writer offers several ways to organize information fields in a form, including check boxes, option buttons, text boxes, pull-down lists, and spinners. Two toolbars are used to create forms: Form Controls and Form Design. See the *Writer Guide* for more information.

Using content controls

Content controls are placeholders. You can add and customize content controls for use in templates, forms, and documents. Content controls can provide instructions on their use. Some are similar to the older form controls, but can be easier to work with and format. However, unlike form fields, content controls do not connect to any data in a database. See the *Writer Guide* for more information.

Determining document accessibility

Writer can analyze a document and determine whether it has accessibility problems. To obtain this information, open the Sidebar and click on the Accessibility Check deck For more information about accessibility checking, see the *Writer Guide*.



LibreOffice
Community



Chapter 3, Getting Started with Calc

Using spreadsheets in LibreOffice

What is Calc?

Calc is the spreadsheet component of LibreOffice. You can enter data (usually numerical) in a spreadsheet and then manipulate this data to discover results.

Other features provided by Calc include:

- Functions, which can be used to create formulas to perform complex calculations on data.
- Database functions, to arrange, store, and filter data.
- Data statistics tools, to perform complex data analysis.
- Dynamic charts, including a wide range of 2D and 3D charts.
- Macros, for recording and executing repetitive tasks; scripting languages supported include LibreOffice Basic, Python, BeanShell, and JavaScript.
- Ability to open, edit, and save Microsoft Excel spreadsheets.
- Import and export of spreadsheets in multiple formats, including HTML, CSV, PDF, and DIF.
- Seamless collaboration with other users by sharing spreadsheets.

Compatibility with other spreadsheet applications

Wildcards

Simple wildcards such as the asterisk (*), question mark (?), and tilde (~) from other spreadsheet applications are recognized by Calc in formula expressions.

Formula syntax

By default, Calc uses its own formula syntax, referred to as Calc A1, rather than the default Excel A1 syntax used by Microsoft Excel. Calc will translate seamlessly between the two. However, if you are familiar with Excel you may wish to change the default syntax by going to **Tools > Options > LibreOffice Calc > Formula** and choosing **Excel A1** or **Excel R1C1** in the *Formula syntax* drop-down menu.

For more information on formula syntax, see Chapter 8, Using Formulas and Functions, in the *Calc Guide*.

Macros

Microsoft Office uses Visual Basic for Applications (VBA) code, and LibreOffice uses Basic code based on the LibreOffice API. Although the programming languages are the same, the objects and methods are different and therefore not entirely compatible.

LibreOffice can run some Excel Visual Basic scripts if you enable this feature at **Tools > Options > Load/Save > VBA Properties**.

If you want to use macros written in Microsoft Excel using the VBA macro code in LibreOffice, you must first edit the code in the LibreOffice Basic IDE editor.

For more information, refer to Chapter 13, Macros, in the *Calc Guide*.

Functions

For many functions, Calc follows the *OpenFormula* standard defined in the *Recalculated Formula (OpenFormula) Format* part of the *Open Document Format for Office Applications*

(*OpenDocument*) standard, which can be accessed at the OASIS website (<https://www.oasis-open.org/>). Calc's general support for *OpenFormula* leads to a level of inherent compatibility with the function set of any other spreadsheet application that follows the same standard. Note that there are some functions within Calc that are not in accordance with *OpenFormula*, but many of these are included specifically to improve the exchange of files between Calc and Microsoft Excel.

Spreadsheets, sheets, and cells

Calc uses spreadsheets, which consist of a number of individual sheets. Each sheet contains cells arranged in rows and columns, and each cell is identified by its row number and column letter.

Cells hold the individual elements – text, numbers, formulas, and so on – that make up the data to display and manipulate.

Each spreadsheet can have up to 10,000 sheets, and each sheet can have a maximum of 1,048,576 rows and a maximum of 16,384 columns.

Calc main window

When Calc is started, the main window opens (Figure 51). The parts of this window are described below. You can show or hide many of the parts as desired, using the View menu on the Menu bar.

Note

By default, Calc's commands are grouped in menus and toolbars, as described in this chapter. In addition, Calc provides other user interface variations, displaying contextual groups of commands and contents. For more information, see Chapter 16, *User Interface Variants*, in the *Calc Guide*.

Title bar

The Title bar, located at the top, shows the name of the current spreadsheet. When a spreadsheet is newly created from a template or a blank document, its name is *Untitled X*, where X is a number. When you save a spreadsheet for the first time, you are prompted to enter a name of your choice.

Menu bar

Under the Title bar is the Menu bar. When you select one of the menu items, a sub-menu drops down to show commands. You can also customize the Menu bar; see Chapter 13, *Customizing LibreOffice*, for more information.

Most of the menus are similar to those in other components of LibreOffice, although the specific commands and tools may vary. The menus specific to Calc are Sheet and Data; in addition, several important data analysis tools are found in the Tools menu and the View menu contains several options that are of specific interest to Calc users.

Sheet

Commands for handling sheets, including options for inserting and deleting elements; renaming, moving, and copying sheets; changing a sheet tab's highlight color; and navigating through multiple sheets.

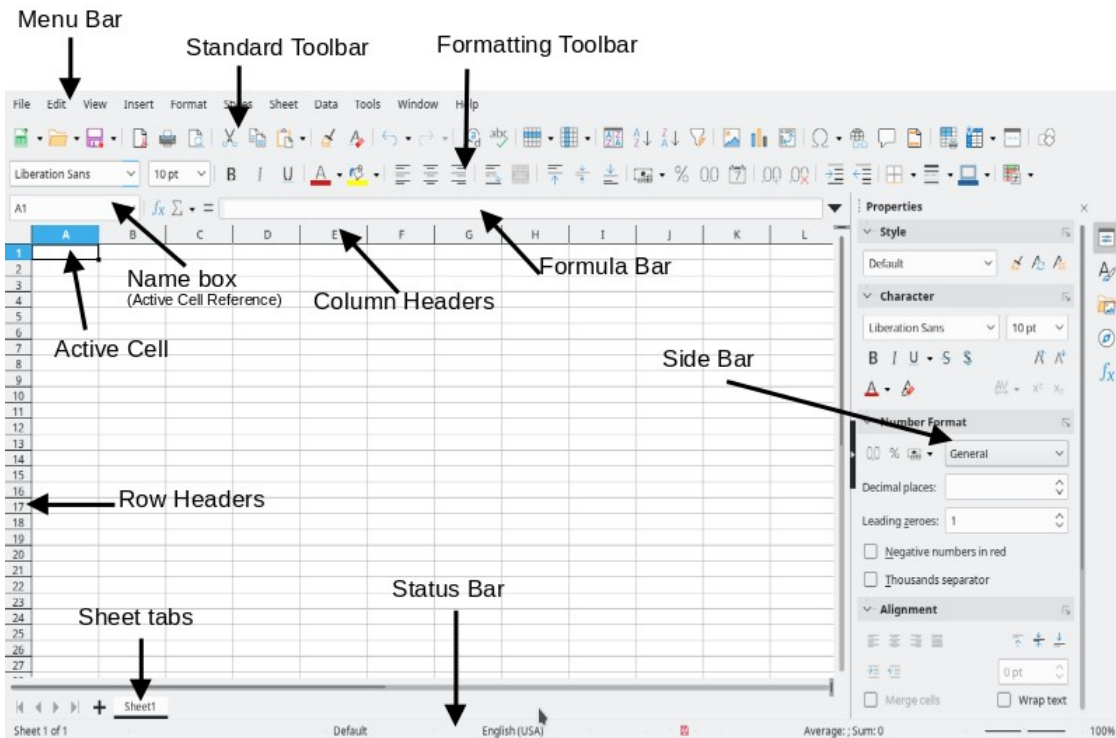

Figure 51: Calc main window

Data

Commands for manipulating and analyzing data, including options for sorting and filtering; defining database ranges; creating pivot tables; defining validity rules; creating subtotals; consolidating; grouping and outlining; and performing various types of statistical analysis.

Tools

Commands for checking and customizing the spreadsheet, including options for spell checking; defining AutoCorrect preferences; applying Goal Seek; using the Solver to solve mathematical equations by goal-seeking methods; using the Detective to investigate dependencies between cells; creating scenarios; sharing and protecting; and using macros.

View

Commands of particular interest to Calc users include Value Highlighting; Column/Row Highlighting; Hidden Row/Column Indicator; and Show Formula.

Toolbars

In a default LibreOffice installation, the top toolbar under the Menu bar is called the Standard toolbar. It is consistent across all LibreOffice applications. For more information about toolbars, see Chapter 1, LibreOffice Basics.

Formula bar

The Formula bar (Figure 52) is located at the top of the cell grid in the Calc workspace. It is permanently docked in this position and cannot be used as a floating toolbar. However, it can be hidden or made visible by going to **View > Formula Bar** on the Menu bar.



Figure 52: Formula bar

From left to right, the Formula bar includes the following:

Name Box

Displays the current active cell reference using a combination of a letter and a number, for example A1. The letter indicates the column and the number indicates the row of the selected cell. If you have selected a range of cells that is also a named range, the name of the range is shown in this box. You can also jump to a specific cell by typing a cell reference in the *Name Box*. If you type the name of a named range and press the *Enter* key, the named range is selected and displayed.

Function Wizard

Opens a dialog from which you can search through lists of available functions. This can be very useful because it also shows how the functions are formatted.

Select Function

This drop-down list provides the options shown in Figure 53 to perform calculations on cells containing numbers.

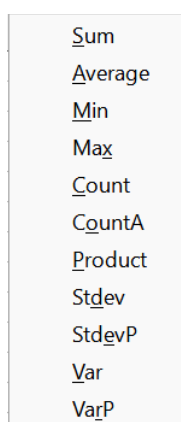

Figure 53: Select Function drop-down

Formula

Inserts an equals (=) sign into the selected cell and the *Input line*, allowing a formula to be entered. The *Name Box* now displays a drop-down list of the most frequently used functions, for a quick access to the function name and syntax.

Input line

Displays the contents of the selected cell (data, formula, or function) and allows you to edit the cell contents. To turn it into a multi-line input area for very long formulas, click the down arrow on the right-hand side of the *Input line*.

You can also directly edit the contents of a cell by double-clicking on the cell. When you enter or edit data in a cell, the **Select Function** and **Formula** icons change to **Cancel** and **Accept** icons.

Note

In a spreadsheet, the term “function” covers much more than just mathematical functions. See Chapter 8, Using Formulas and Functions, in the *Calc Guide* for more information.

Status bar

The Status bar (Figure 54) provides information about the spreadsheet as well as quick and convenient ways to change some of its features. Most of the fields are similar to those in other components of LibreOffice. See Chapter 1, LibreOffice Basics, for more information.

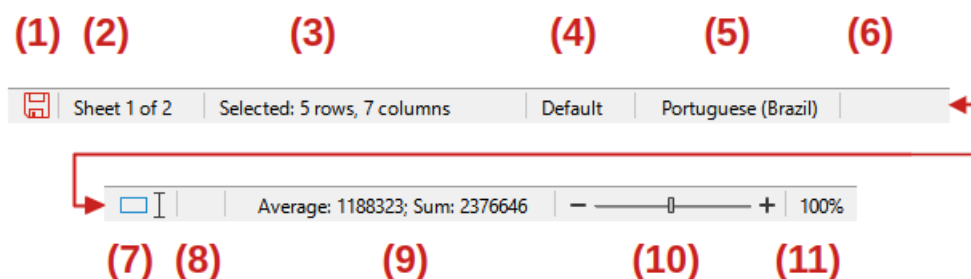

Figure 54: Status bar

- | | | |
|--------------------------------|---------------------------|-----------------------------|
| (1) Save/Unsaves changes | (5) Text Languages | (9) Cell/Object information |
| (2) Sheet number | (6) Insert/Overwrite mode | (10) Zoom slider |
| (3) Cell selection information | (7) Selection mode | (11) Zoom percentage |
| (4) Page Style | (8) Digital Signature | |

The Status bar can allow you to do quick math operations on selected cells. You can view the calculated average and sum, count of elements, and more on the selection by right-clicking over the Cell/Object Information area and selecting the operations you want to display in the Status bar (Figure 55).

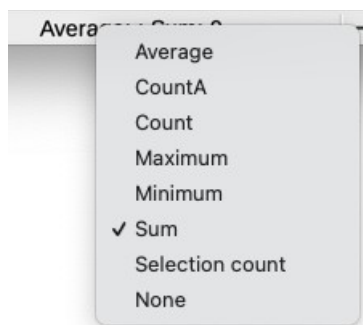

Figure 55: Selecting math operations on Status bar

Sidebar

The Sidebar (**View > Sidebar** or *Ctrl+F5*) is located on the right-hand side of the window. It is similar to the Sidebar in Writer (shown in Chapter 1 and Chapter 2 of this book) and consists of five decks: **Properties**, **Styles**, **Gallery**, **Navigator**, and **Functions**. Each deck has a corresponding icon on the Tab panel on the right-hand side of the Sidebar, allowing you to switch between them. The decks are described below.

Properties

With a cell selected, this deck includes five content panels. Each of these panels has a **More Options** button that opens a dialog with additional options. These dialogs lock the spreadsheet for editing until they are closed.

Style: Options for applying, creating, and updating cell styles.

Character: Options for formatting the text, such as font name, size, weight, and color. Some controls, such as superscript, become active only when the text cursor is active in the *Input line* of the Formula bar or the cell. A font is temporarily applied on selected cells when hovering or navigating in the *Font Name* list.

Number Format: Options for formatting numbers, including decimals, percentages, currency, and dates. Covers decimal places, leading zeroes, coloring negative numbers, and displaying thousands separators.

Alignment: Options for arranging the text in various ways, including horizontal and vertical alignment, wrapping, indenting, orientation, and vertical stacking. Also provides for cell merging.

Cell Appearance: Options for controlling the appearance of cells, including background color and border formats.

The set of panels displayed in this deck depends on the type of object that is currently selected. For example, with a chart selected, the Properties deck contains Line, Position and Size, Area, and Shadow panels. Not all panels in the Properties deck provide a **More Options** button.

Styles, Gallery, Navigator

These decks are similar to those in Writer. Their use is described in the *Calc Guide*. Note that Calc supports three style types – cell styles, page styles, and drawing styles.

Functions

This deck contains a searchable list of functions organized by category. It is a simpler version of the Function Wizard, which is opened by selecting **Insert > Function** on the Menu bar, clicking the **Function Wizard** icon on the Formula bar, or pressing *Ctrl+F2*.

Spreadsheet layout

Individual cells

The main section of the Calc workspace displays the cells in the form of a grid. Each cell is formed by the intersection of one column and one row in the spreadsheet.

At the top of the columns and the left of the rows are a series of header boxes containing letters and numbers. The column headers use alphabetic characters beginning at A and go on to the right (to column XFD). The row headers use numerical characters starting at 1 and go down.

These column and row headers form the cell references that appear in the *Name Box* on the Formula bar (Figure 52). If the headers are not visible on the spreadsheet, choose **View > View Headers** on the Menu bar.

When the mouse pointer lies over the grid of cells, the system default pointer is normally shown (typically an arrow pointer). However, a configuration option is available to switch to using the pointer shape defined in the icon theme (typically a fat cross). For more information, see Chapter 15, *Setting up and Customizing*, in the *Calc Guide*.

The active cell is always indicated by highlighting its corresponding column and row header cells. An option is available to highlight the entire row and column of the active cell using a transparent color. This is enabled/disabled using the **Tools > Options > LibreOffice Calc > View > Column/Row highlighting** and **View > Column/Row Highlighting** options on the Menu bar.

Sheet tabs

Each Calc spreadsheet can contain multiple sheets, which are displayed as tabs at the bottom of the spreadsheet window. By default, each new spreadsheet is created with one sheet named *Sheet1* and you can create additional sheets as needed. The tab for the active sheet is highlighted and you can select multiple sheets by holding down the *Ctrl* key while clicking on the sheet tabs.

To change the default name for a sheet (*Sheet1*, *Sheet2*, and so on), right-click on a sheet tab and select **Rename Sheet** in the context menu, to open the Rename Sheet dialog where you can type a new name for the sheet. You can also access the Rename Sheet dialog by double-clicking on the sheet tab or going to **Sheet > Rename Sheet** on the Menu bar.

To change the color of a sheet tab, right-click on the tab and select **Tab Color** in the context menu to open the Tab Color dialog. Select a color and click **OK**. You can also access the Tab Color dialog by going to **Sheet > Sheet Tab Color** on the Menu bar. To add new colors to this color palette, see Chapter 13, Customizing LibreOffice.

Opening and importing a CSV file

A comma-separated values (CSV) file contains data in tabular format. In many cases, CSV files contain data exported from a database, resulting in a file in which each line corresponds to a record from a table or query. You can import such data into Calc for further analysis and charting. A CSV file stores data in a text format, separating values with a specific delimiter character. The delimiter is often a comma but may be a semicolon, a vertical bar, or any other character. Before you open a CSV file in Calc, make sure you know which character is the delimiter. Each line in a CSV file represents a row in a spreadsheet.

To open a CSV file in Calc:

- 1) Choose **File > Open** on the Menu bar, click the **Open** icon on the Standard toolbar, or press *Ctrl+O*, and then locate the CSV file. Most CSV files have the extension .csv but some CSV files may have a .txt extension.
- 2) Select the file and click **Open**.
- 3) On the Text Import dialog (Figure 56), select the required options for importing the CSV file into the Calc spreadsheet. For details about these options, see Chapter 1, Introduction, in the *Calc Guide*.

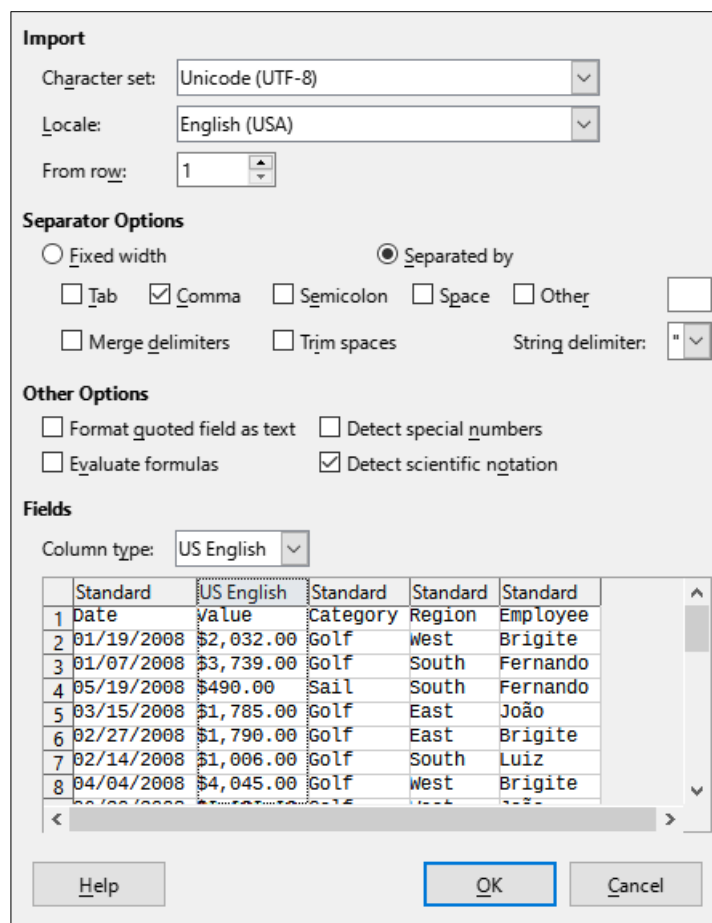

Figure 56: Text Import dialog



Tip

CSV files from different sources may adopt various formats. As you select and deselect options in the upper part of the Text Import dialog, use the preview area in the lower part of the dialog to verify that the layout of the imported data is as expected.

4) Click **OK** to import the file.



Caution

Know how your CSV file is formatted before you open it in Calc. Not knowing how the CSV is structured is a source for errors and miscalculations.

Saving spreadsheets

For information on how to save files manually or automatically, see Chapter 1, LibreOffice Basics. Calc can save spreadsheets in a range of formats and also export spreadsheets to PDF and XHTML file formats or JPEG, PNG, and WEBP image formats; see Chapter 7, Printing, Exporting, Emailing, and Signing, in the *Calc Guide* for more information.

Saving files in different formats

You can save a spreadsheet in another format:

- 1) Save the spreadsheet in Calc spreadsheet file format (*.ods).
- 2) Select **File > Save As** on the Menu bar to open the Save As dialog. You can also open this dialog by pressing the *Ctrl+Shift+S* keyboard shortcut, or by clicking the arrowhead icon to the right of the **Save** icon on the Standard toolbar and selecting **Save As** in the drop-down menu.
- 3) Select the folder where you want to save the file.
- 4) In the *File name* field, enter a new file name for the spreadsheet.
- 5) In the *Save as type* drop-down list, select the type of spreadsheet format you want to use.
- 6) If **Automatic file name extension** is present and selected, the correct file extension for the spreadsheet format you have selected will be added to the file name.
- 7) Click **Save**.

When a spreadsheet file is saved in a format other than .ods, by default the Confirm File Format dialog opens (Figure 57). Click **Use [xxx] Format** to continue saving in your selected spreadsheet format or click **Use ODF Format** to save the spreadsheet in Calc .ods format. If you uncheck *Ask when not saving in ODF or default format*, this dialog no longer appears when saving in another format (the same option can also be found at **Tools > Options > Load/Save > General > Warn when not saving in ODF or default format**).

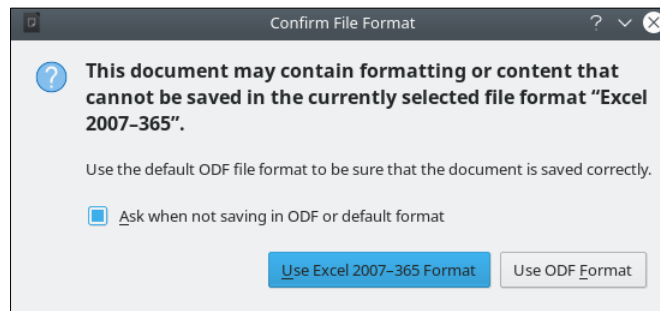

Figure 57: Confirm File Format dialog

If you select **Text CSV (*.csv)** format for your spreadsheet, the Export Text File dialog (Figure 58) opens. Here you can set the CSV format for your file, including the character set, the field delimiter, and the string (text) delimiter.

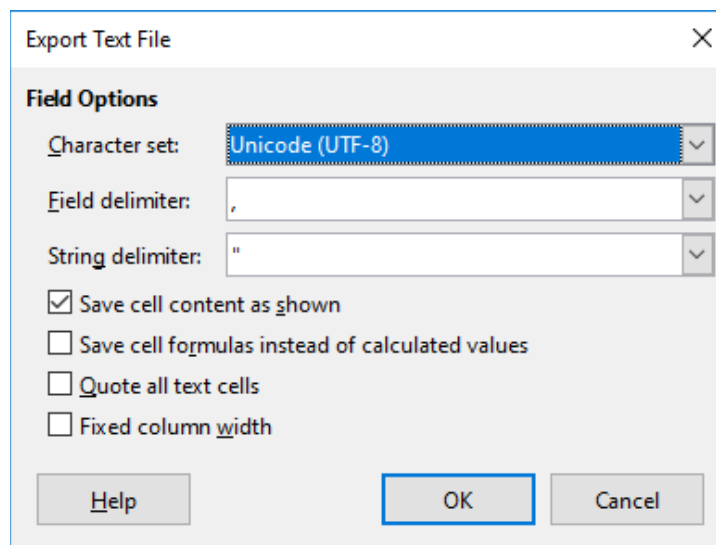

Figure 58: Export Text File dialog for CSV files

Note

Once you have saved a spreadsheet in another format, all changes you make to the spreadsheet will be in that format. If you want to go back to working with a *.ods version, you must save the file as a *.ods file.

Tip

To have Calc save spreadsheets by default in a file format other than .ods, go to **Tools > Options > Load/Save > General**. In the *Default File Format and ODF Settings* area, select **Spreadsheets (Calc)** in *Document type*, then in *Always save as*, select your preferred file format.

Exporting values and formulas as a CSV file

Calc can export raw data and calculated data into a CSV file. Figure 59 contains an example of data for export, and Figure 60 shows the resulting CSV file.

The steps to export are:

- 1) Save the spreadsheet in Calc spreadsheet file format (*.ods), for backup purposes.
- 2) Select the sheet to be written as a CSV file.

- 3) Go to **View > Formula** on the Menu bar. Alternatively, go to **Tools > Options > LibreOffice Calc > View** on the Menu bar, *check* the **Formulas** option in the *Display* area, and click **OK**.
- 4) Select **File > Save As** on the Menu bar to open the Save As dialog. You can also open this dialog by pressing the *Ctrl+Shift+S* keyboard shortcut, or by clicking the arrowhead icon to the right of the **Save** icon on the Standard toolbar and selecting **Save As** in the drop-down menu.
- 5) Select the folder where you want to save the file.
- 6) In the *File name* field, enter a new file name for the CSV file.
- 7) In the *Save as type* drop-down list, select **Text CSV (*.csv)**.
- 8) If **Automatic file name extension** is present and selected, the correct file extension for the spreadsheet format you have selected will be added to the file name.
- 9) Click **Save**.
- 10) From the Export Text File dialog (Figure 58) that appears, select **the required options**, and click **OK**.

ID	First Name	Last Name	Full Name	Number
1002	Mary	Alexander	=CONCATENATE(B2," ",C2)	739-495-8304
1005	Steve	Bacon	=CONCATENATE(B3," ",C3)	379-663-8918
1003	Patrice	Budreau	=CONCATENATE(B4," ",C4)	290-635-0135
1010	Jose	Gonzalez	=CONCATENATE(B5," ",C5)	278-270-8386
1001	Krishna	Gupta	=CONCATENATE(B6," ",C6)	943-583-8274
1006	Vicky	Li	=CONCATENATE(B7," ",C7)	190-544-9208
1004	Rose	Mokoro	=CONCATENATE(B8," ",C8)	603-883-8313
1009	Trinh	Nguven	=CONCATENATE(B9," ",C9)	573-861-0905

Figure 59: Exporting raw and calculated values

1	"ID","First Name","Last Name","Full Name","Number"
2	1002,"Mary","Alexander", "=CONCATENATE (B2,C2) ", "739-495-8304"
3	1005,"Steve","Bacon", "=CONCATENATE (B3,C3) ", "379-663-8918"
4	1003,"Patrice","Budreau", "=CONCATENATE (B4,C4) ", "290-635-0135"
5	1010,"Jose","Gonzalez", "=CONCATENATE (B5,C5) ", "278-270-8386"
6	1001,"Krishna","Gupta", "=CONCATENATE (B6,C6) ", "943-583-8274"
7	1006,"Vicky","Li", "=CONCATENATE (B7,C7) ", "190-544-9208"
8	1004,"Rose","Mokoro", "=CONCATENATE (B8,C8) ", "603-883-8313"
9	1009,"Trinh","Nguven", "=CONCATENATE (B9,C9) ", "573-861-0905"

Figure 60: CSV file containing raw and calculated values

Exporting contents as an image

If you need to export a range selection or a selected group of shapes (images) into a graphics format, do the following

- 1) Select the cell range or the group of shapes, then select **File > Export**.
- 2) In the Export dialog, type a name for the image, select the graphics file format (PNG, JPG, or WEBP), and mark the **Selection** checkbox.
- 3) Click **Save**.

If necessary, Calc may give you additional options to configure the settings associated with the graphics format.

Exporting a whole sheet as one page

If you need to view an entire sheet, Calc can export a sheet as a PDF in one page.

The steps to export the contents to one page:

- 1) On the Menu bar, select **File > Export as PDF**.
- 2) On the *General* tab of the PDF Options dialog (Figure 61), select the option **Whole sheet export**.
- 3) Click the **Export** button, and choose a location for the PDF.

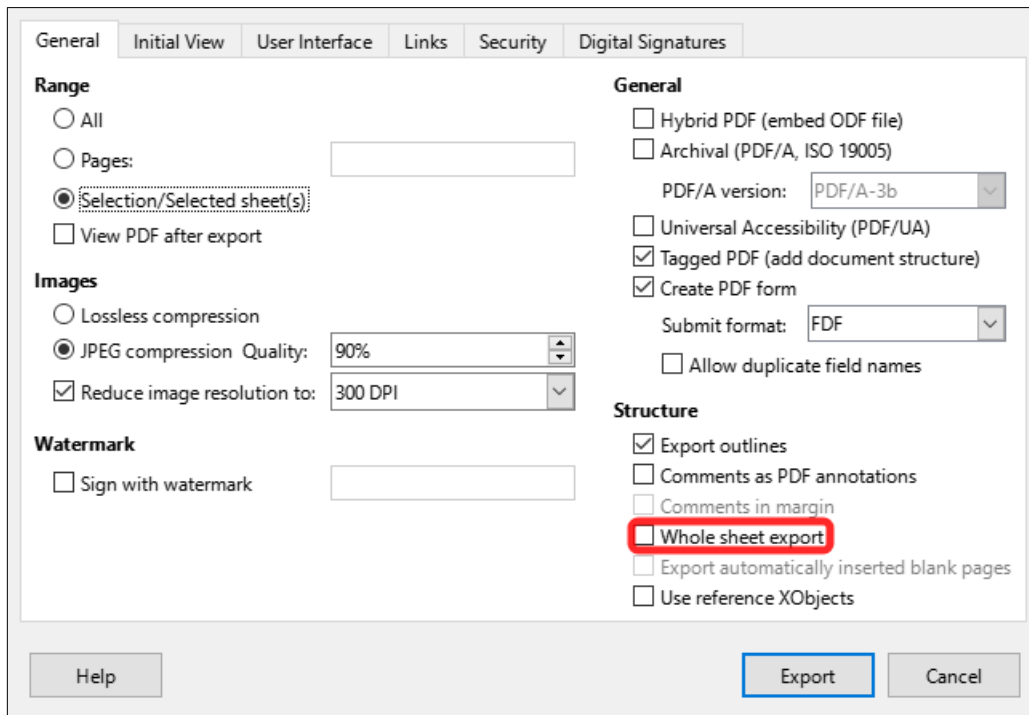

Figure 61: Exporting sheets to PDF as one page

Importing external data – Web Query

Calc can import data from HTML linking to an external data source with web query. You can filter or choose the table to import by HTML caption:

- 1) Position the cursor in the cell where you want the new content to be imported.
- 2) Choose **Sheet > External Links** to open the External Data dialog (Figure 62).
- 3) Enter the URL of the HTML document or the name of the spreadsheet, then press *Enter*. You can also click the **Browse** button to open a file selection dialog.
- 4) In the *Available Tables/Ranges* list box, select the named ranges or tables you want to insert. You can also specify that the ranges or tables can be updated every *n* seconds. These tables are now listed in the order they appear in the source. Click **OK** to finish.

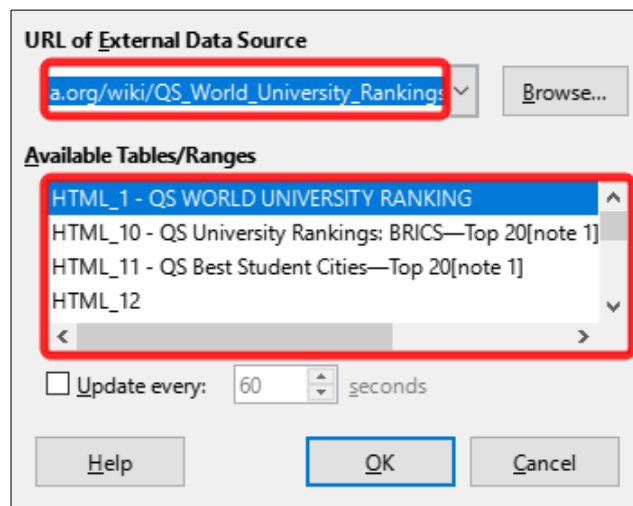

Figure 62: Link to external data

Navigating within spreadsheets

Calc provides many ways to navigate within a spreadsheet, including methods for moving from cell to cell and sheet to sheet.

Cell navigation

When a cell is selected or in focus, a colored rectangle is drawn around the cell. When a group of cells is selected, the background of the cell area is colored. The colors depend on the operating system being used and how you have set up LibreOffice.

Mouse: Place the mouse pointer over the cell and click the left mouse button.

Cell reference: Delete the existing cell reference in the *Name Box* on the *Formula bar* (Figure 52). Type the new cell reference and press *Enter*. Cell references are case-insensitive.

Navigator: Open the Navigator (Figure 63) by pressing *F5* or going to **View > Navigator** on the Menu bar. Type the cell reference into the *Column* and *Row* fields, or use the adjacent increment / decrement buttons, and press *Enter*. Equivalent interactions are available on the Navigation deck of the Sidebar.

Enter key: By default, moves the cell focus down in a column to the next row. *Shift+Enter* moves the focus up in a column to the previous row. You can change the action of the *Enter* key; see “Customizing the Enter key” below.

Tab key: Moves the cell focus right in a row to the next column. *Shift+Tab* moves the focus to the left in a row to the previous column.

Arrow keys: Use these keys to move the cell focus in the direction of the arrow pressed.

Home, End, Page Up, and Page Down keys:

- *Home* moves the cell focus to the start of a row. *Ctrl+Home* moves the cell focus to the first cell in the sheet, A1.
- The result of pressing *End* or *Ctrl+End* depends on the data contained in the sheet. To explain these key presses, it is helpful to define R_{\max} as the highest numbered row in the sheet that contains any data and C_{\max} as the rightmost column in the sheet that contains any data. Press *End* to move the cell focus along the current row to the cell in column C_{\max} . Press *Ctrl+End* to move the cell focus to the cell at the intersection of

row R_{\max} and column C_{\max} . Note that in either case, the newly focused cell may not contain any data.

- *Page Down* moves the cell focus down one complete screen display.
- *Page Up* moves the cell focus up one complete screen display.

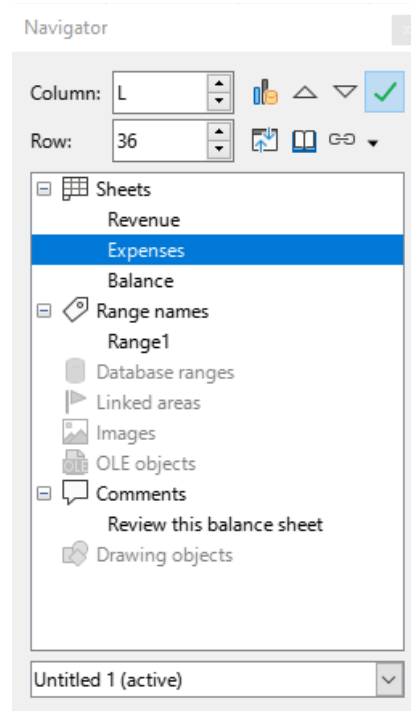

Figure 63: Calc Navigator

Sheet navigation

Each sheet in a spreadsheet is independent of the other sheets, though references can create links between one sheet to another. To navigate between sheets in a spreadsheet:

Navigator – double-click on any of the sheets listed in the Navigator to select that sheet.

Keyboard – *Ctrl+Page Down* moves one sheet to the right and *Ctrl+Page Up* moves one sheet to the left. *Ctrl+Tab* is equivalent to *Ctrl+Page Down*, while *Ctrl+Shift+Tab* is equivalent to *Ctrl+Page Up*. These interactions operate in a cyclic manner. For example, if currently on the first sheet tab, then *Ctrl+Page Up* moves to the last sheet tab.

Mouse – click on a sheet tab at the bottom of the spreadsheet to select that sheet.

Menu – go to **Sheet > Navigate > To Previous Sheet / To Next Sheet** on the Menu bar to navigate to previous or next sheet. These interactions operate in the same cyclic manner as described above for their equivalent keyboard shortcuts. **Sheet > Navigate > Go to Sheet** brings up a dialog box that allows you to select a sheet or to search for a sheet by name.

If your spreadsheet contains multiple sheets, then some of the sheet tabs may be hidden. If this is the case:

- Using the four arrowhead buttons to the left of the sheet tabs can move the tabs into view (Figure 64).
- Right-clicking on any of these buttons, or the adjacent + button, opens a context menu where you can select a specific sheet (Figure 65).

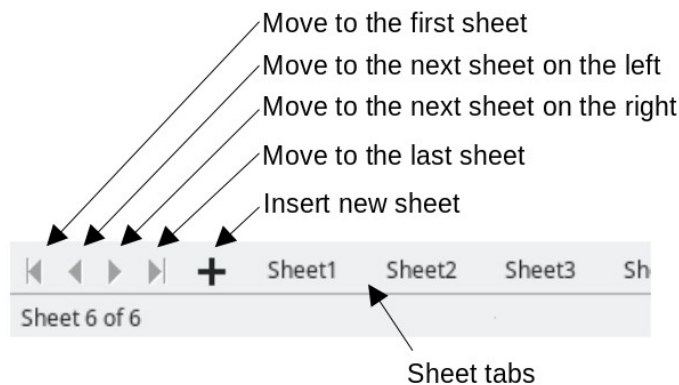

Figure 64: Navigating sheet tabs

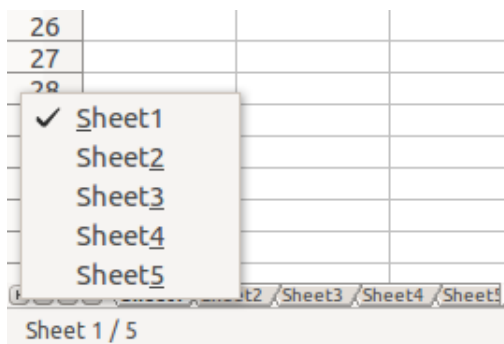

Figure 65: Right-click any active arrow button

 **Note**

When you insert a new sheet into a spreadsheet, Calc automatically uses the next number in the numeric sequence to construct a name. To improve navigation, rename sheets in a spreadsheet to make them more recognizable.

Keyboard navigation

You can navigate a spreadsheet using the keyboard, by pressing a key or a combination of keys. See Chapter 1, Introduction, and Appendix A, Keyboard Shortcuts, in the *Calc Guide* for the keys and key combinations you can use for spreadsheet navigation in Calc.

Customizing the Enter key

You can customize the behavior of the *Enter* key by going to **Tools > Options > LibreOffice Calc > General** on the Menu bar and using the upper three options in the *Input Settings* area (Figure 66).

- **Press Enter to move selection:** check this option to choose the direction that the cell focus moves after you press the *Enter* key. Select the required direction of movement in the adjacent drop-down menu (**Down**, **Right**, **Up**, or **Left**).
- **Press Enter to switch to edit mode:** checking this option causes *Enter* to open the highlighted cell for editing. Uncheck to make the *Enter* key select the adjacent cell in the direction of movement defined by the **Press Enter to move selection** option.
- **Press Enter to paste and clear clipboard:** checking this option causes *Enter* to paste the content of the clipboard to the highlighted cell, subsequently clearing the clipboard.

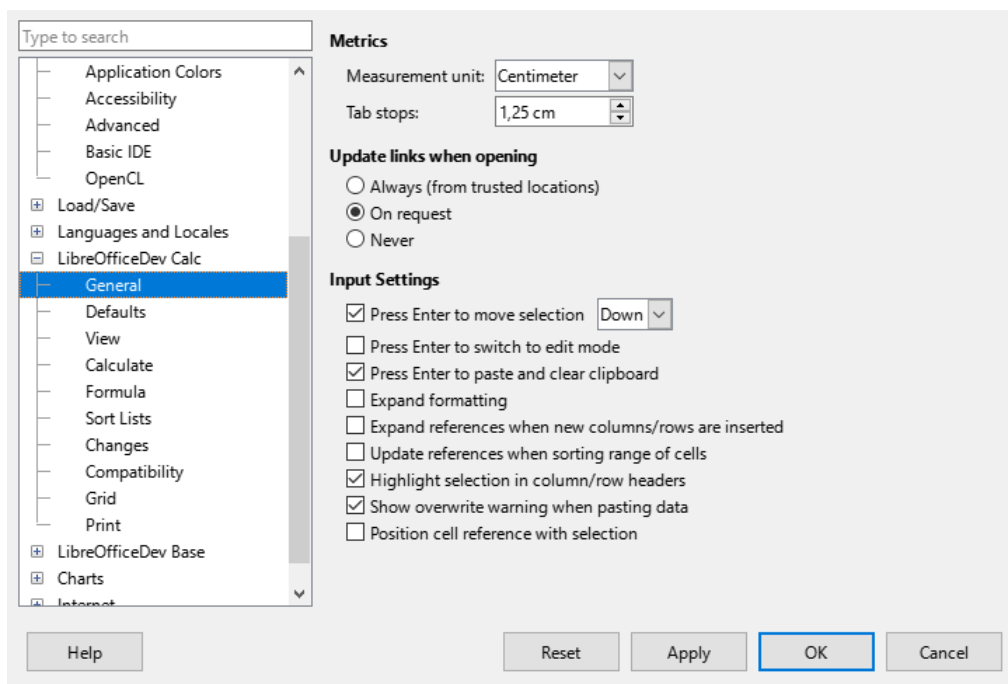

Figure 66: Customizing the Enter key

Selecting items in a spreadsheet

Selecting cells

Single cell

Click in the cell. You can verify your selection by looking in the *Name Box* on the Formula bar (Figure 52).

Range of contiguous cells

A range of cells can be selected using the keyboard or the mouse.

To select a range of cells with the mouse:

- 1) Click in a cell.
- 2) Press and hold down the left mouse button.
- 3) Move the mouse to highlight the desired block of cells, then release the mouse button.

To select a range of cells using the mouse, but without dragging:

- 1) Click in the cell at one corner of the range of cells.
- 2) Hold down the *Shift* key and click in the opposite corner cell of the block of cells.

Tip

You can choose a contiguous range of cells by clicking the *Selection mode* area on the Status bar (Figure 54) and selecting **Extending selection** before clicking in the opposite corner of the range of cells. Once you are done, make sure to change back to **Standard selection** or you may extend a cell selection unintentionally.

To select a range of cells using the keyboard:

- 1) Click in the cell at one corner of the range of cells.

2) While holding down the *Shift* key, use the cursor arrows to select the rest of the range.

Tip

You can also directly select a range of cells using the *Name Box*. Click in the *Name Box* on the Formula bar (Figure 52). Enter the cell reference for the upper left-hand cell, followed by a colon (:), and then the lower right-hand cell reference. For example, to select the range that would go from A3 to C6, you would enter A3 : C6.

Range of non-contiguous cells

To select a range of non-contiguous cells using the mouse:

- 1) Select the first cell or range of cells using one of the methods described in the previous paragraphs.
- 2) Move the cursor to the start of the next range or single cell.
- 3) Hold down the *Ctrl* key and click or click-and-drag to select another range of cells to add to the first range.
- 4) Repeat as necessary.

Tip

You can choose non-contiguous ranges of cells by clicking the *Selection mode* area on the Status bar (Figure 54) and selecting **Adding selection**. Click or click-and-drag to select ranges of cells to add to the selection.

Selecting columns and rows

Single column or row

To select a single column, click on the column header (Figure 51). To select a single row, click on the row header.

Multiple columns or rows

To select multiple columns or rows that are contiguous:

- 1) Click on the header of the first column or row in the group.
- 2) Hold down the *Shift* key.
- 3) Click on the header of the last column or row in the group.

To select multiple columns or rows that are not contiguous:

- 1) Click on the header of the first column or row in the group.
- 2) Hold down the *Ctrl* key.
- 3) Click on the headers of all subsequent columns or rows while holding down the *Ctrl* key.

Tip

You can also select rows and columns using options in the **Edit > Select** menu on the Menu bar (**Select Row**, **Select Column**, **Select Visible Rows Only**, and **Select Visible Columns Only**).

Entire sheet

To select the entire sheet, click on the blank rectangular area to the left of the column headers and above the row headers (Figure 67). Alternatively you can press *Ctrl*+*A*, press *Ctrl*+*Shift*+*Space*, or go to **Edit > Select All** on the Menu bar.

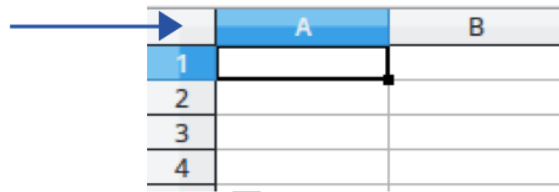

Figure 67: Select All box

Selecting sheets

If you want to make changes to many sheets at once you can select one or multiple sheets in Calc.

Single sheet

Click on the sheet tab for the sheet you want to select. The tab for the selected sheet changes appearance – in the default Calc setup, the tab background color changes to white, the text on the tab changes to bold, and a colored line is drawn along the bottom edge of the tab.

Multiple contiguous sheets

To select multiple contiguous sheets:

- 1) Click on the sheet tab for the first desired sheet.
- 2) Hold down the *Shift* key and click on the sheet tab for the last desired sheet.
- 3) All tabs between these two selections will change appearance. Any actions that you perform will now affect all the highlighted sheets.

Multiple non-contiguous sheets

To select multiple non-contiguous sheets:

- 1) Click on the sheet tab for the first desired sheet.
- 2) Hold down the *Ctrl* key and click on the sheet tab for the each additional desired sheet.
- 3) The selected tabs will change appearance. Any actions that you perform will now affect all the highlighted sheets.

All sheets

Right-click a sheet tab and choose **Select All Sheets** in the context menu, or select **Edit > Select > Select All Sheets** on the Menu bar.

Tip

You can also select sheets using the Select Sheets dialog, accessed by selecting **Edit > Select > Select Sheets** on the Menu bar.

Working with columns and rows

Inserting columns and rows

Single column or row

Using the Sheet menu:

- 1) Select the cell location where you want the new column or row inserted.
- 2) Go to **Sheet** on the Menu bar and select either **Insert Columns > Columns Before**, **Insert Columns > Columns After**, **Insert Rows > Rows Above**, or **Insert Rows > Rows Below**.

Using row and column headers:

- 1) Right-click the column or row header where you want the new column or row inserted.
- 2) Select **Insert Columns Before**, **Insert Columns After**, **Insert Rows Above**, or **Insert Rows Below** in the context menu.

Multiple columns or rows

To insert multiple columns or rows at once:

- 1) Highlight the required number of columns or rows by holding down the left mouse button on the first one and then dragging across the required number of identifiers.
- 2) Proceed as for inserting a single column or row above.

Hiding and showing columns and rows

To hide columns or rows:

- 1) Select cells in the rows or columns you want to hide.
- 2) Go to **Format** on the Menu bar, select **Rows** or **Columns**, and select **Hide** in the submenu. Alternatively, right-click on selected row or column headers and select **Hide Rows** or **Hide Columns** in the context menu.

To show hidden columns or rows:

- 1) Select cells in the rows or columns on each side of the hidden rows or columns.
- 2) Go to **Format** on the Menu bar, select **Rows** or **Columns**, and select **Show** in the submenu. Alternatively, right-click on selected row or column headers and select **Show Rows** or **Show Columns** in the context menu.



Tip

To see an indicator for hidden columns and rows, enable the **View > Hidden Row/Column Indicator** option on the Menu bar.

Deleting columns or rows

To delete multiple columns or rows, do one of the following:

- Select a range of cells across the columns or rows you want to delete, right-click and select **Delete** in the context menu, select **Sheet > Delete Cells** on the Menu bar, or press **Ctrl+-** to open the Delete Cells dialog (Figure 68). Select **Delete entire column(s)** or **Delete entire row(s)** and click **OK**.
- Select a range of cells across the columns or rows you want to delete and select **Sheet > Delete Columns** or **Sheet > Delete Rows** on the Menu bar.

- Highlight the required columns or rows by holding down the left mouse button on the header of the first one and then dragging across the required number of headers. Then right-click on one of the selected column or row headers and select **Delete Columns** or **Delete Rows** in the context menu.

Deleting cells

- 1) Select the cells you want to delete. Choose the **Sheet > Delete Cells command**, press **Ctrl+-**, or right-click on a cell and select **Delete** in the context menu.
- 2) When the Delete Cells dialog (Figure 68) appears, select the appropriate option and click **OK**.

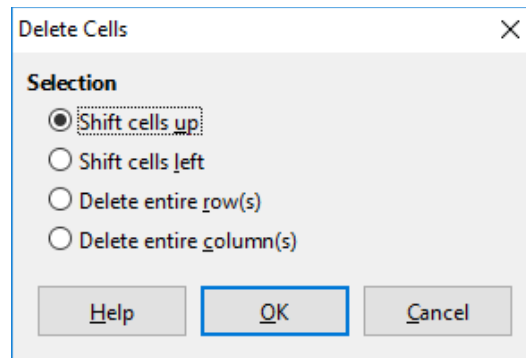

Figure 68: Delete Cells dialog

Working with sheets

Inserting new sheets

If you need to insert a new sheet after the last sheet in a spreadsheet without opening the Insert Sheet dialog, click the **Add Sheet (+)** icon next to the sheet tabs. After clicking on the icon, the new sheet appears with an automatically allocated name.

The Insert Sheet dialog (Figure 69) provides greater flexibility and is accessed by one of the following methods:

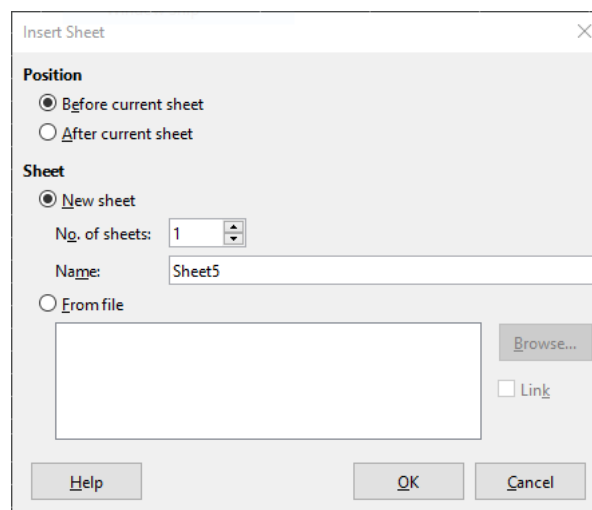

Figure 69: Insert Sheet dialog

- Select the sheet where you want to insert a new sheet, then go to **Sheet > Insert Sheet** on the Menu bar.

- Right-click on the sheet tab where you want to insert a new sheet and select **Insert Sheet** in the context menu.

The Insert Sheet dialog is used to position the new sheet, create multiple sheets, name the new sheet, or select a file containing the data to be inserted into the new sheet.

Moving and copying sheets

You can move a sheet to a different position within the same spreadsheet, by clicking on the sheet's tab and dragging it to a new position before releasing the mouse button. You can copy a sheet within the same spreadsheet, by holding down the *Ctrl* key, clicking on the sheet tab, and dragging it to its required position before releasing the mouse button. You can also copy a sheet by right-clicking the sheet's tab and selecting **Duplicate Sheet** in the context menu, or by going to **Sheet > Duplicate Sheet** on the Menu bar.

The Move/Copy Sheet dialog (Figure 70) provides greater flexibility and, in particular, allows you to move or copy a sheet into a different spreadsheet.

- 1) To access the Move/Copy Sheet dialog, right-click on the sheet tab you wish to move or copy and then select **Move or Copy Sheet** in the context menu, or go to **Sheet > Move or Copy Sheet** on the Menu bar.
- 2) In the *Action* area, select **Move** to move the sheet or **Copy** to copy the sheet.
- 3) Select the spreadsheet where you want the sheet to be placed in the *To document* drop-down list.
- 4) In the *Insert before* list, choose the position in the target spreadsheet where you want to place the sheet.
- 5) Enter a name in the *New name* box if you want to rename the sheet after it is moved or copied. If you do not enter a name, Calc automatically generates one.
- 6) Click **Move** or **Copy** to confirm the move or copy and close the dialog.

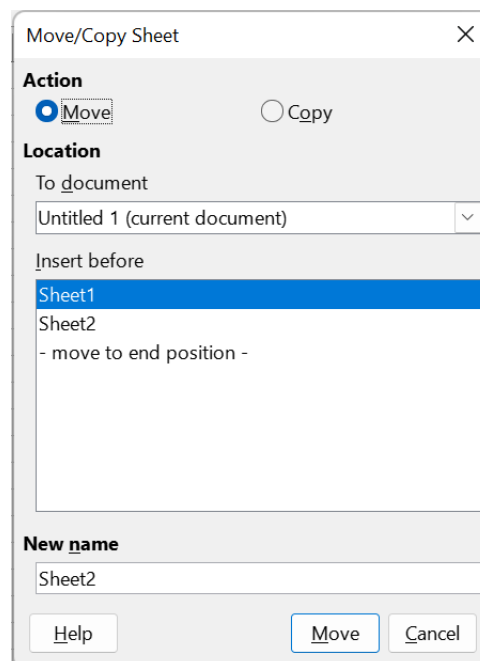

Figure 70: Move/Copy Sheet dialog

Caution

When you move or copy a sheet to another spreadsheet, a conflict may occur with formulas linked to other sheets in the previous location.

Hiding and showing sheets

If you need to hide one or more sheets, first select the sheets. Then right-click on one of the selected sheet tabs and select **Hide Sheet** in the context menu, or go to **Sheet > Hide Sheet** on the Menu bar. It is not possible to hide the last visible sheet.

To display hidden sheets, right-click on any sheet tab and select **Show Sheet** in the context menu, or go to **Sheet > Show Sheet** on the Menu bar. Calc displays the Show Sheet dialog, listing all hidden sheets. Select the hidden sheets to be displayed again and then click **OK**.

It is also possible to hide and show elements within a sheet, as described in various chapters of the *Calc Guide*.

Renaming sheets

Every time a new sheet is created without specifying a name, it is automatically named *SheetX* (where X is an incrementing number allocated by Calc). The first sheet in a new spreadsheet is named *Sheet1*.

A sheet can be renamed using one of the following methods:

- Enter a new name in the *Name* text box when creating the new sheet using the Insert Sheet dialog (Figure 69).
- Right-click on the sheet's tab and select **Rename Sheet** in the context menu to open the Rename Sheet dialog.
- Select the sheet's tab and go to **Sheet > Rename Sheet** on the Menu bar to open the Rename Sheet dialog.
- Double-click on the sheet's tab to open the Rename Sheet dialog.

Note

Sheet names can contain almost any character. Some naming restrictions apply, the following characters are not allowed in sheet names: colon (:), back slash (\), forward slash (/), question mark (?), asterisk (*), left square bracket ([), or right square bracket (]). In addition a single quote (') cannot be used as the first or last character of the name. Attempting to rename a sheet with an invalid name will produce an error message.

Deleting sheets

To delete one or more sheets, first select the sheets (see “Selecting sheets” on page 126). Then right-click on one of the selected sheet tabs and select **Delete Sheet** in the context menu, or go to **Sheet > Delete Sheet** on the Menu bar. If any of the selected sheets is not empty, then Calc displays a confirmation dialog stating the number of sheets to be deleted. Click **Yes** to confirm the deletion. It is not possible to delete all the sheets in a spreadsheet.

Viewing a spreadsheet

Changing document view

Use the zoom function (**View > Zoom**) to show more or fewer cells in the window when you are working on a spreadsheet. For more about zoom, see Chapter 1, LibreOffice Basics.

Freezing rows and columns

If you have long rows or columns of data that extend beyond the viewable area of the sheet, you can freeze selected rows or columns. In this way you can lock rows across the top of a sheet or lock columns down the left of a sheet, so that the frozen data remains displayed as you scroll through the rest of the data. Vertical scrolling does not affect the visibility of data in a frozen row; horizontal scrolling does not affect the visibility of data in a frozen column.

The sheet shown in Figure 71, has frozen rows and columns, which are outlined by heavy lines. Columns A through F and rows 1 through 3 are frozen. The rows between 3 and 23 and the columns between F and Q are scrolled off the page.

	A	B	C	D	E	F	Q	R
1		Date	Sales Value	Category	Region	Employee		
2		04/13/08	\$498	Sailing	North	Kurt		
3		02/07/08	\$1,383	Sailing	South	Kurt		
23		03/27/08	\$669	Sailing	South	Hans		
24		01/28/08	\$155	Sailing	West	Brigitte		

Figure 71: Frozen rows and columns

To freeze the first column in a sheet go to **View > Freeze Cells > Freeze First Column** on the Menu bar, or click the down arrow to the right of the **Freeze Rows and Column** icon on the Standard toolbar and select **Freeze First Column** in the drop-down menu.

To freeze the first row in a sheet go to **View > Freeze Cells > Freeze First Row** on the Menu bar, or click the down arrow to the right of the **Freeze Rows and Column** icon on the Standard toolbar and select **Freeze First Row** in the drop-down menu.

To freeze *either* a set of rows or a set of columns (single or multiple):

- 1) Click on the header of the row *below* all the rows you want to freeze, or click on the header of the column to the *right* of all the columns you want the freeze.
- 2) Right-click on the header and select **Freeze Rows and Columns** in the context menu, or go to **View > Freeze Rows and Columns** on the Menu bar, or click the **Freeze Rows and Columns** icon on the Standard toolbar.

To freeze *both* a set of rows and a set of columns (single or multiple):

- 1) Click in the cell that is immediately *below* the rows you want to freeze and immediately to the *right* of the columns you want frozen.
- 2) Choose **View > Freeze Rows and Columns** on the Menu bar, or click the **Freeze Rows and Columns** icon on the Standard toolbar.

Unfreezing

To unfreeze all rows and columns that are currently frozen, do one of the following:

- Right-click on any row or column header and choose **Freeze Rows and Columns** in the context menu.
- Select **View > Freeze Rows and Columns** on the Menu bar.
- Click the **Freeze Rows and Columns** icon on the Standard toolbar.

The heavy lines that indicate frozen rows and columns will disappear.

Splitting the screen

Calc allows you to view different areas of a sheet simultaneously by splitting the screen into separate sections. Each section provides you with a view of one part of the sheet. This feature is also known as “splitting the window.” The screen can be split horizontally, vertically, or both at once (which would give you up to four sections of the sheet in view at one time). Figure 72 provides an example of a sheet split horizontally into two sections, with the split indicated by the gray separator line located between rows 2 and 7.

This feature is especially useful when a large spreadsheet has one cell containing data that is used by three formulas in different cells. When you split the screen, you can position the cell containing the number in one section of the view and the cells with formulas in other sections. This makes it easy to see how changing the number in one cell affects each of the formulas.

	A	B	C
1		Beta=	3.2
2		A0=	0.1
7	A1=	Beta*A0*(1*A0)	0.6421
8	A2=	Beta*A1*(1*A0)	0.6582
9	A3=	Beta*A0*(1*A0)	0.7219
10	A4=	Beta*A0*(1*A0)	0.6574
11	A5=	Beta*A0*(1*A0)	0.6597
12			

Figure 72: Split screen example

Splitting horizontally or vertically

There are two methods to split a screen *either* horizontally or vertically. In these cases, you can scroll through each section independently of the other. A horizontal or vertical separator line appears indicating where the split has been placed.

Method 1

- To split horizontally, you can right-click on the row header *below* the row where you want to split and select **Split Window** in the context menu. Alternatively you can left-click on the row header *below* the row where you want to split and then go to **View > Split Window** on the Menu bar or click the **Split Window** icon on the Standard toolbar.
- To split vertically, you can right-click on the column header to the *right* of the column where you want to split and select **Split Window** in the context menu. Alternatively you can left-click on the column header to the *right* of the column where you want to split and then go to **View > Split Window** on the Menu bar or click the **Split Window** icon on the Standard toolbar.

Method 2

- To split horizontally, click on the horizontal split bar at the top of the vertical scroll bar (Figure 73 – left) and drag it down to a position *below* the row where you want the horizontal split.
- To split vertically, click on the vertical split bar at the right of the horizontal scroll bar (Figure 73 – right) and drag it left to a position to the *right* of the column where you want the vertical split.

Splitting horizontally and vertically

There are two methods to split a screen *both* horizontally and vertically at the same time. Horizontal and vertical separator lines appear indicating where the split has been placed.

Method 1

- Click in the cell that is *below* the row and to the *right* of the column where you want to split. Go to **View > Split Window** on the Menu bar or click the **Split Window** icon on the Standard toolbar.

Method 2

- Click on the horizontal split bar at the top of the vertical scroll bar (Figure 73 – left) and drag it down to a position *below* the row where you want the horizontal split. Then, click on the vertical split bar to the right of the horizontal scroll bar (Figure 73 – right) and drag it left to a position to the *right* of the column where you want the vertical split.

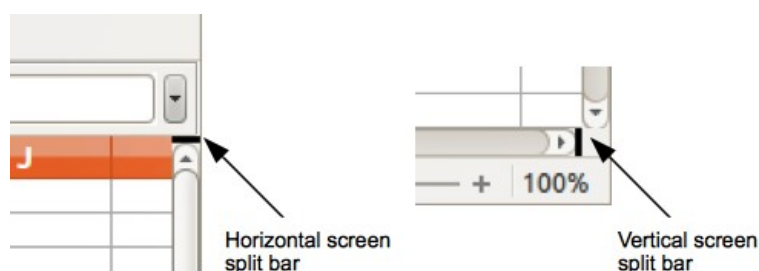

Figure 73: Split screen bars

Removing split views

To remove a split view, do one of the following:

- Double-click on each split line.
- Click and drag the split lines back to their default positions at the ends of the scroll bars.
- Go to **View** on the Menu bar and deselect **Split Window**.
- Right-click on a column or row heading and deselect **Split Window** in the context menu.
- Click the **Split Window** icon on the Standard toolbar.

Entering data using the keyboard

Most data entry in Calc is done with the keyboard.

Numbers

Click in the cell and type the number using the number keys on either the main keyboard or the numeric keypad. By default, Calc right-aligns the numbers in a cell.

Negative numbers

To enter a negative number, either type a minus (–) sign in front of the number or enclose the number in parentheses (1234). The negative number will be displayed as follows: –1234.

Leading zeroes

If a number is entered with leading zeroes (for example, 01481), Calc will drop the leading zeroes by default. To retain a minimum number of characters in a cell when entering numbers and retain the number format, for example 1234 and 0012, use one of two methods to add leading zeroes:

Method 1

- 1) Select the cell that will retain leading zeroes, then access the Format Cells dialog (Figure 74) by doing one of the following:
 - Right-click on the selected cell then choose **Format Cells** in the context menu.
 - Go to **Format > Cells** on the Menu bar.
 - Press *Ctrl+1*.
- 2) Select the *Numbers* tab and select **Number** in the *Category* list.
- 3) In the *Options* area, set the *Leading zeroes* field to the maximum number of zeroes to display in front of the integer part of the number. If you want to display numbers with four integer digits, enter the value 4. Then any number containing less than four integer digits will have leading zeroes added – for example 12 is displayed as 0012.

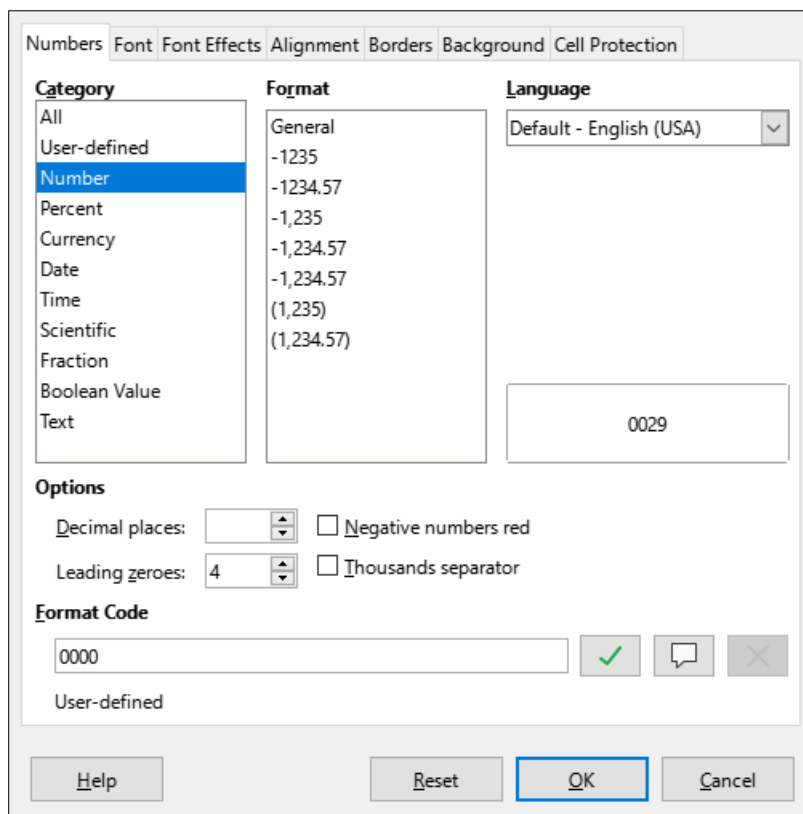

Figure 74: Format Cells dialog – Numbers tab

- 4) Click **OK**. The number in the selected cell retains its number format and any formula used in the spreadsheet will treat the entry as a number in formula functions.

Method 2

- 1) Select the cell.
- 2) On the Sidebar, go to the Properties deck.

- 3) On the Number Format panel (Figure 75), select **Number** in the drop-down list, and enter the maximum number of zeroes to display in front of the integer part of a number in the *Leading zeroes* box. Formatting is applied immediately.

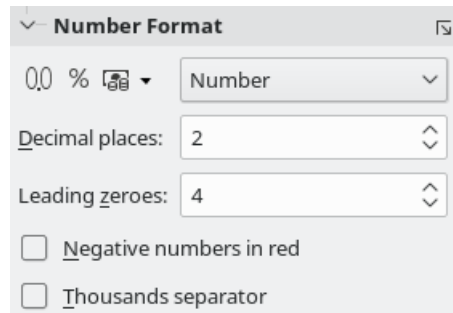

Figure 75: Set leading zeroes in Sidebar

Tip

To format numbers with decimal places and prevent a leading zero (for example, “.019” instead of “0.019”), go to the *Format code* box on the *Numbers* tab of the Format Cells dialog and then type a period or full stop and add one or more question marks (“?”). Each question mark represents a decimal place. For example, for 3 decimal places, type one period and three question marks [. ???] and click **OK**. Any number with only decimal places will then have no leading zero.

Tip

If a numeric value does not need to be treated as a number in calculations (for example when entering a zip code), you can type an apostrophe (') before the number, for example "' 01481". When you move the cell focus, the apostrophe is hidden, any leading zeroes are retained, and the number is converted to left-aligned text.

Numbers as text

Numbers can also be entered as text using one of the following methods:

Method 1

- 1) Select the cell which contains the number, then access the Format Cells dialog (Figure 74).
- 2) Make sure the *Numbers* tab is selected, then select **Text** in the Category list.
- 3) Click **OK**. The number is converted to text and, by default, left-aligned.

Method 2

- 1) Select the cell.
- 2) On the Sidebar, go to the Properties deck.
- 3) On the Number Format panel (Figure 75), select **Text** in the drop-down list. Formatting is applied to the cell immediately.

Note

You can change how Calc converts strings to numeric values, cell references, dates, and times by going to **Tools > Options > LibreOffice Calc > Formula**. In the *Detailed Calculation Settings* area, select **Custom (conversion of text to numbers)**

and more). Click the **Details** button, and then select the proper treatment in the Detailed Calculation Settings dialog. See the system help for more information.

Text

To enter text in a cell, click in the cell and type. By default, text is left-aligned in a cell. Cells can contain several lines of text. If you want to use paragraphs, press *Ctrl+Enter* to create another paragraph.

If you are entering several lines of text, extend the *Input line* by clicking on the **Expand Formula Bar** icon, which is located on the right-hand end of the Formula bar, and then the *Input line* becomes multi-line. Click the icon again to return the *Input line* to its single line height.

Date and time

Select the cell and type the date or time. You can separate the date elements with a slash (/) or a hyphen (-), or use text, for example 10 Oct 2020. The date format automatically changes to the selected format used by Calc.



Note

Tools > Options > Languages and Locales > General > Formats > Date acceptance patterns defines the date patterns that will be recognized by Calc. In addition, every locale accepts input in an ISO 8601 YYYY-MM-DD pattern (for example, 2020-07-26).

When entering a time, separate time elements with colons (for example, 10:43:45) and the time format automatically changes to the selected format used by Calc.

To change the date or time format used by Calc:

- 1) With the cell selected, open the Format Cells dialog (Figure 74).
- 2) Make sure the *Numbers* tab is selected, then select **Date** or **Time** in the *Category* list.
- 3) Select the date or time format you want to use in the *Format* list.
- 4) Click **OK**.

Cell fields

If you wish to insert a date, the sheet name, or the document name in a cell as a field, do the following:

- 1) Select a cell and double-click to activate edit mode.
- 2) Right-click and select **Insert Field > Date, Sheet Name, or Document Title** in the context menu. The **Insert Field** sub-menu contains two **Date** options – use the occurrence located directly above the **Sheet Name** item. Alternatively you can go to **Insert > Field > Date, Sheet Name, or Document Title** on the Menu bar.
- 3) The fields are updated with the latest information when the spreadsheet is saved or recalculated using the *Ctrl+Shift+F9* shortcut or going to **Data > Calculate > Recalculate Hard** on the Menu bar.



Note

The other **Insert Field > Date** option and its associated **Time** option in the context menu insert the current date and time respectively. However, unlike the commands described above, these values are not inserted as fields and will not be updated or

recalculated later. Similarly, the **Insert > Date** and **Insert > Time** options on the Menu bar do not insert values as fields.

Note

The **Document Title** commands insert the name of the spreadsheet. They do not insert the title defined on the *Description* tab of the Properties dialog for the file.

AutoCorrect Options

Calc automatically applies many changes during data input using AutoCorrect, unless you have deactivated any AutoCorrect changes. For more information, refer to Chapter 2, Entering and Editing Data, in the Calc Guide. You can also undo any AutoCorrect changes by using **Edit > Undo** on the Menu bar, pressing the keyboard shortcut *Ctrl+Z*, or manually by going back to the change and replacing the automatic correction with what you want.

To change how AutoCorrect works, go to **Tools > AutoCorrect Options** on the Menu bar to display the AutoCorrect dialog (Figure 76):

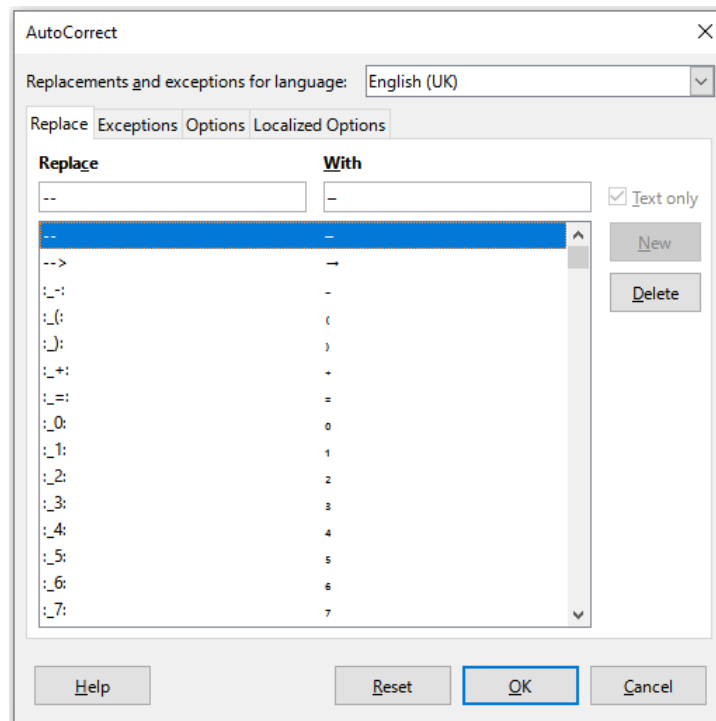

Figure 76: AutoCorrect dialog

Replace tab

Edit the replacement table for automatically correcting or replacing words or abbreviations.

Exceptions tab

Specify the abbreviations or letter combinations that you do not want corrected automatically.

Options tab

Select the options for automatically correcting errors as you type.

Localized Options tab

Specify the AutoCorrect options for quotation marks and for options that are specific to the language of the text.

Reset button

Reset modified values back to their previous values.

Deactivating automatic changes

To turn off some or all AutoCorrect features, go to **Tools > AutoCorrect Options** on the Menu bar and uncheck unwanted features on the *Options* and *Localized Options* tabs on the AutoCorrect dialog.

Speeding up data entry

Calc provides multiple tools for removing some of the drudgery from input. The most common tool is to drag and drop the contents of one cell to another with a mouse. Other tools include AutoInput, the Fill tool, selection lists, the Data Entry tool, and the ability to input information into multiple sheets of the same document.

AutoInput tool

The AutoInput tool in Calc automatically completes entries, based on other entries in the same column. By default, AutoInput is activated in Calc. To turn it off, go to **Tools** on the Menu bar and deselect **AutoInput**.

When text is highlighted in a cell, AutoInput can be used as follows:

- Press *Enter* to accept the completion and move to the next cell. Press *F2* to accept the completion and move the cursor to the end of the text inside the cell. Clicking outside the cell will accept the completion and select the clicked cell.
- When multiple matches continue with the same letters they will appear in the cell after what has already been typed. Press *Right Arrow* to accept the partial completion and move the cursor to the end of the text inside the cell.
- To view more completions that start with the same letters, use the key combinations *Ctrl+Tab* to scroll forward, or *Ctrl+Shift+Tab* to scroll backward.
- To see a list of all available AutoInput text items for the current column, use the keyboard combination *Alt+Down Arrow*.

When typing formulas using characters that match function names, a help tip will appear listing the available functions that start with matching characters. AutoInput ignores the case sensitivity of any data you enter.

Filling cells

This tool allows you to duplicate existing content or create a series across a range of cells (see examples in Figure 77) using one of the following methods.

Caution

When you are selecting cells to use the Fill tool, make sure that none of the cells contain important data, except for the cell data you want to use. When you use the Fill tool, any data contained in the selected target cells is overwritten.

Method 1

- 1) Select one or more cells that contain the contents you want to copy or start the series from.
- 2) Drag the mouse pointer to fill the cells in any direction you desire, or hold down the *Shift* key and click in the last cell you want to fill.

- Go to **Sheet > Fill Cells** on the Menu bar and select the direction in which you want to copy or create data (**Fill Down**, **Fill Right**, **Fill Up**, **Fill Left**) or one of the other options (**Fill Sheets**, **Fill Series**, **Fill Random Number**) in the submenu. For more information about the **Fill Sheets** and **Fill Random Number** options, see Chapter 2, Entering and Editing Data in the *Calc Guide*.

 **Tip**

Ctrl+D is an alternative to selecting **Sheet > Fill Cells > Fill Down** on the Menu bar.

Method 2

- Select one or more cells that contain the contents you want to copy or start the series from.
- Move the mouse pointer over the small square in the bottom right corner of the selected cells. The mouse pointer will change shape.
- Click and drag in the direction you want the cells to be filled. If the original cell contained a number or text from a defined sort list, then a series will be created. However, if the *Ctrl* button is pressed while dragging, then the original data is copied instead. If the original cell contained any other text, then that text will automatically be copied.

A2:A8		A2:A8	
	A		A
1	Duplicate Fill	1	Series Fill
2	Original	2	1234
3	Original	3	1235
4	Original	4	1236
5	Original	5	1237
6	Original	6	1238
7	Original	7	1239
8	Original	8	1240

Figure 77: Using the Fill tool

Using a fill series

When you select a series fill from **Sheet > Fill Cells > Fill Series** on the Menu bar, the Fill Series dialog (Figure 78) opens. Here you can select the type of series you want. For more detail about this dialog, see Chapter 2, Entering and Editing Data in the *Calc Guide*.

Fill Series ✕

Direction	Series Type	Time Unit
<input checked="" type="radio"/> Down	<input checked="" type="radio"/> Linear	<input type="radio"/> Day
<input type="radio"/> Right	<input type="radio"/> Growth	<input type="radio"/> Weekday
<input type="radio"/> Up	<input type="radio"/> Date	<input type="radio"/> Month
<input type="radio"/> Left	<input type="radio"/> AutoFill	<input type="radio"/> Year

Start value:

End value:

Increment:

Figure 78: Fill Series dialog

Defining a fill series

When a fill is initiated and the selected cell contains text, Calc will check if one of your predefined sort lists contains that text. If there is a sort list containing the text, Calc uses the entries in that sort list to fill cells. Go to **Tools > Options > LibreOffice Calc > Sort Lists** to view your currently defined sort lists.

To define your own sort list, which can later be used as a fill series:

- 1) Go to **Tools > Options > LibreOffice Calc > Sort Lists** to open the Sort Lists dialog (Figure 79). This dialog shows any previously-defined series in the *Lists* box and the contents of the highlighted list in the *Entries* box.
- 2) Click **New** and the *Entries* box is cleared.
- 3) Type the series for the new list in the *Entries* box (one entry per line).
- 4) Click **Add** and the new list will appear in the *Lists* box.
- 5) Click **OK** to save the new list.

Filling text cells with selection lists

Selection lists are limited to using only text that has already been entered in the same column.

- 1) Select a blank cell in a column that contains cells with text entries.
- 2) Right-click and select **Selection Lists** in the context menu, or press *Alt+Down Arrow*. A context menu appears listing any cell in the same column that either has at least one text character or whose format is defined as text.
- 3) Click on the text entry you require and it is entered into the selected cell.

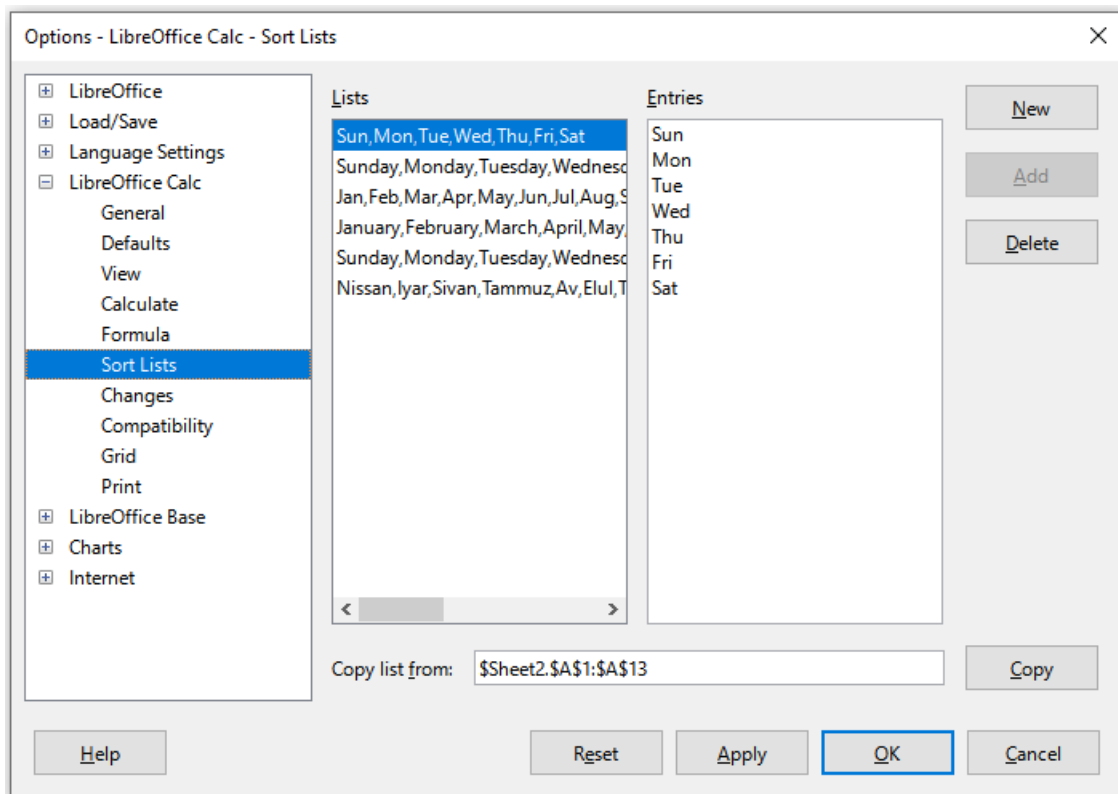

Figure 79: Sort Lists dialog

Data Entry Form tool

This tool makes table data entry easier in spreadsheets, accelerating intensive manual input. Using the tool you can enter, edit, and delete data records (or rows) and avoid horizontal scrolling when the table has many columns or when some columns are very wide.

To be effective, the data table should have a header row, where the content of each cell is the title of the column. The content of each header cell becomes the label for each data field in the form.

To use the Data Entry Form tool:

- 1) Select a header or data cell within the table of data.
- 2) Go to **Data > Form** on the Menu bar.
- 3) Calc displays the Data Form dialog (Figure 80), showing the data for the first entry in the data table.
- 4) Add, edit, or remove entries from the data table as required.
- 5) Click the **Close** button to close the dialog.

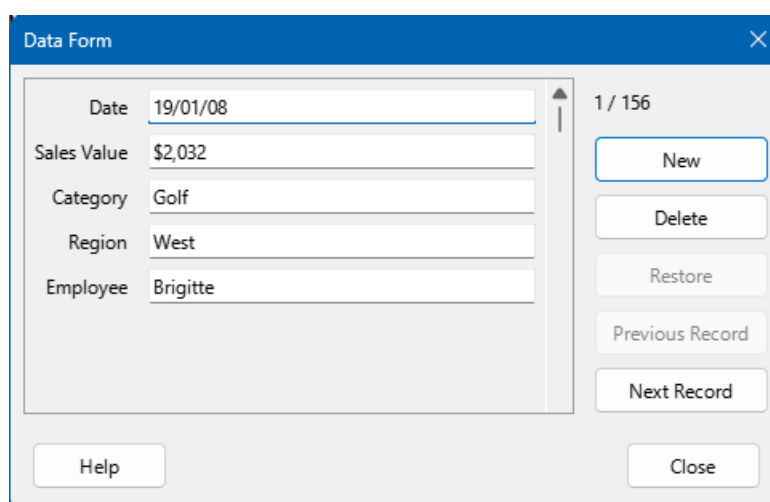

Figure 80: Data Form dialog

Sharing content between sheets

You might want to share the same information in the same cell on multiple sheets (for example, to set up standard listings for a group of individuals or organizations). Instead of entering the list on each sheet individually, you can enter the information in several sheets at the same time.

- 1) Select the individual sheets where you want the information to be repeated. See the section “Selecting sheets” above for more details.
- 2) Enter the information in the cells on the first sheet where you want it to appear and it will be repeated in all the selected sheets.

Caution

This technique automatically overwrites, without any warning, any information that is already in the cells on the selected sheets. Make sure you deselect the additional sheets when you are finished entering information that is going to be repeated before continuing to enter data into the spreadsheet.

Validating cell contents

When creating a spreadsheet, you may want to restrict users to entering data that is valid and appropriate for the cell. Fill tools and selection lists can handle some types of data, but are limited to predefined information.

To add data validation to a cell, select that cell and use **Data > Validity** on the Menu bar to define which types of content can be entered in the cell. The Validity tool can:

- Define the range of contents that can be entered.
- Provide help messages explaining the content rules set up for the cell.
- Determine what happens if a user enters invalid content. You can set the cell to refuse invalid content, accept it with a warning, or start a macro when an error is entered.

See Chapter 2, *Entering and Editing Data*, in the *Calc Guide* for more information.

Editing data

Calc has multiple tools for data editing, including the ability to delete data, replace data, and change data.

Replacing data

To completely replace data in a cell, select the cell and type in the new data. The new data will replace the old, but cell formatting will be retained.

Alternatively, select the cell and click in the *Input line* on the Formula bar (Figure 52), then double-click on the data to highlight it completely and type the new data.

Changing data

Calc can allow you to edit the contents of a cell without removing all of the data from the cell. For example, changing the phrase “Sales in Qtr. 2” to “Sales rose in Qtr” can be done as follows.

Using the keyboard

- 1) Click in the cell to select it.
- 2) Press *F2* to switch the cell to edit mode. The cursor is placed at the end of the content in the cell.
- 3) Use the keyboard arrow keys to position the cursor where you want to start entering the new data in the cell, then press the *Delete* key or *Backspace* key to delete any unwanted data before typing the new data.
- 4) When you have finished editing, press the *Enter* key to save the changes.



Tip

You may want to enable **Tools > Options > LibreOffice Calc > General > Press Enter to switch to edit mode**. Then, when you press the *Enter* key in a selected cell, the cell switches to edit mode, eliminating the need to press *F2*.

Using the mouse

- 1) Use one of the following methods to prepare for editing cell data:
 - Double-click on the cell to select it and enter cell edit mode.

- Click in the cell to select it and press *F2* to enter cell edit mode.
 - Click in the cell to select it and go to **Edit > Cell Edit Mode** on the Menu bar to enter cell edit mode.
 - Click in the cell to select it and then click in the *Input line* of the Formula bar.
- 2) Reposition the cursor to where you want to start editing the data, either in the cell or the *Input line*.
 - 3) When you have finished, click away from the cell to deselect it and save the changes.

Paste Special function

To copy text, numbers, or formulas to the target cell or cell range:

- 1) Select the source cell or cell range and copy the data by pressing *Ctrl+C*, going to **Edit > Copy** on the Menu bar, clicking the **Copy** icon on the Standard toolbar, or right-clicking and selecting **Copy** in the context menu.
- 2) Select the target cell or cell range.
- 3) Right-click on the target cell or cell range and select **Paste Special** in the context menu, then select **Unformatted Text**, **Text**, **Number**, or **Formula**. Alternatively, use the equivalent submenu items reached from **Edit > Paste Special** on the Menu bar.

You can also use the Paste Special dialog to paste into another cell selected parts of the data in the original cell or cell range, for example its format or the result of its formula. To do this:

- 1) Select the source cell or cell range and copy the data by pressing *Ctrl+C*, going to **Edit > Copy** on the Menu bar, clicking the **Copy** icon on the Standard toolbar, or right-clicking and selecting **Copy** in the context menu.
- 2) Select the target cell or cell range.
- 3) Go to **Edit > Paste Special > Paste Special** on the Menu bar, or press *Ctrl+Shift+V*, or right-click and select **Paste Special > Paste Special** in the context menu to open the Paste Special dialog (Figure 81).

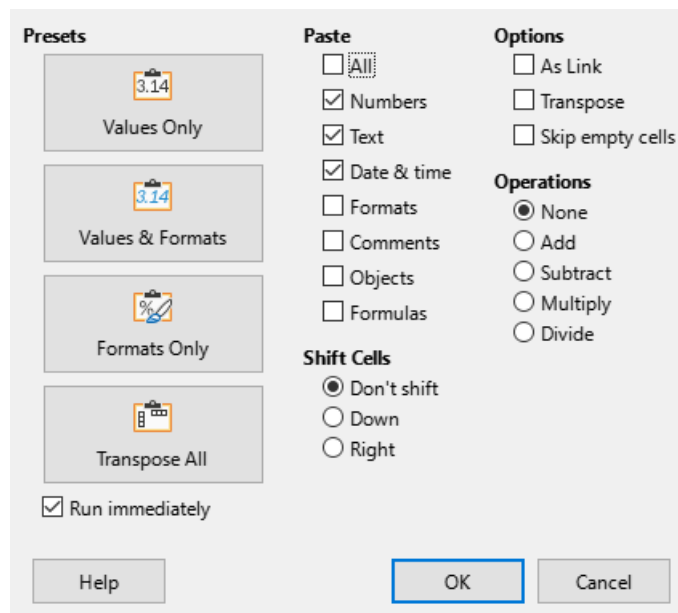

Figure 81: Paste Special dialog

- 4) In the preset buttons on the left side of the dialog, you can choose to paste **Values Only**, **Values & Formats**, **Formats Only**, or to **Transpose All** the data in the target cells. On

the right side of the dialog, select the options for *Paste*, *Options*, *Operations*, and *Shift Cells*. These are described in Chapter 2, *Entering and Editing Data*, in the *Calc Guide*.

5) Click **OK** to paste the data into the target cell or range of cells and close the dialog.

Tip

To see which combination of options on the right side would apply if one of the buttons in the *Presets* area is selected, deselect the *Run immediately* option. With the *Run immediately* option selected, clicking on a preset button applies that combination of options and closes the dialog.

Deleting data

Deleting data only

To delete only the data in a cell or range of cells, without deleting any of the cell formatting, select the cells and then press the *Delete* key.

To completely delete rows or columns, see the “Deleting columns or rows” section above. To completely delete cells, see the “Deleting cells” section above.

Deleting data and formatting

Data and cell formatting can be deleted from a cell at the same time. To do this:

- 1) Select a cell or a range of cells.
- 2) Press the *Backspace* key, or right-click in the cell selection and choose **Clear Contents** in the context menu, or select **Sheet > Clear Cells** on the Menu bar.
- 3) In the Delete Contents dialog (Figure 82), choose any of the options or **Delete all**.
- 4) Click **OK**.

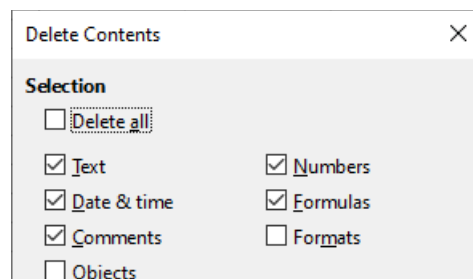

Figure 82: Delete Contents dialog

Formatting data

Note

All the settings discussed here can be set as a part of the cell style. See Chapter 5, *Using Styles and Templates*, in the *Calc Guide* for more information.

Multiple lines of text

Multiple lines of text can be entered into a single cell using automatic wrapping or manual line breaks.

Automatic wrapping

To automatically wrap multiple lines of text in a cell, use one of the following methods:

Method 1

- 1) Select the cell and then access the Format Cells dialog (Figure 74).
- 2) On the *Alignment* tab (Figure 83), under *Properties*, select **Wrap text automatically** and click **OK**.

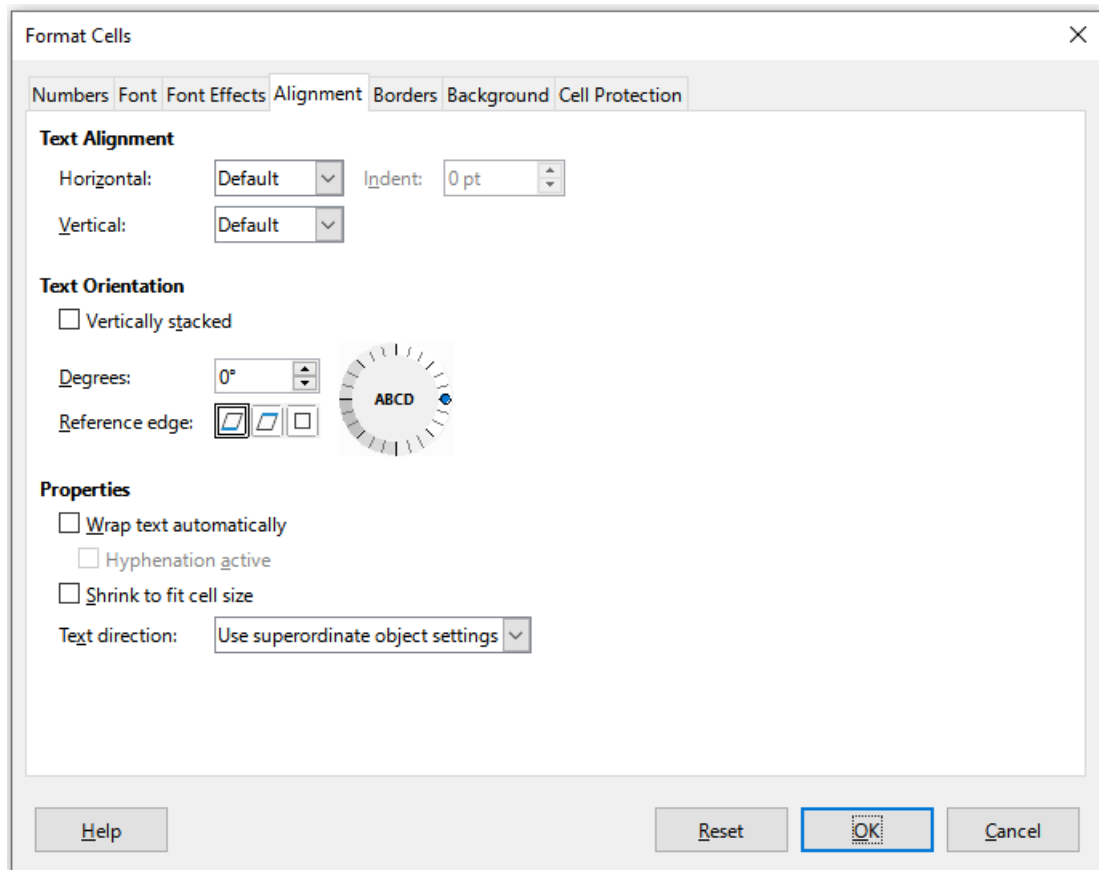

Figure 83: Format Cells dialog – Alignment tab

Method 2

- 1) Select the cell.
- 2) On the Properties deck of the Sidebar, open the Alignment panel (Figure 84).
- 3) Select the **Wrap text** option to apply the formatting immediately.

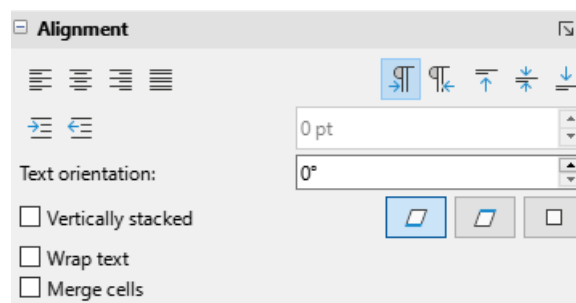

Figure 84: Wrap text formatting

Method 3

- 1) Select the cell.

- 2) Click the **Wrap Text** icon on the Formatting toolbar.

Manual line breaks

To insert a manual line break in a cell, press *Ctrl+Enter*. When editing text, double-click the cell, then reposition the cursor to where you want the line break. In the *Input line* of the Formula bar, you can also press *Shift+Enter*.

When a manual line break is entered in a cell, the cell row height changes but the cell width does not change and the text may still overlap the end of the cell. You may need to change the cell width manually or reposition the line break.

Shrinking text to fit the cell

The font size of the data in a cell can automatically adjust to fit inside cell borders. To do this, select the **Shrink to fit cell size** option under *Properties* on the *Alignment* tab of the Format Cells dialog (Figure 83).

Merging cells

You can select contiguous cells and merge them into one large cell by:

- 1) Selecting the range of contiguous cells you want to merge.
- 2) Performing one of these steps:
- 3) Right-clicking on the selected cells and select **Merge Cells** in the context menu.
- 4) Going to **Format > Merge and Unmerge Cells > Merge Cells** or **Merge and Center Cells** on the Menu bar. Using **Merge and Center Cells** will center align any contents in the cells.
- 5) Clicking on the **Merge Cells** or **Merge and Center Cells** icon on the Formatting toolbar.
- 6) If the cells contain any data, a small dialog (Figure 85) opens, showing choices for moving or hiding data in the hidden cells. Make your selection and click **OK**.

Caution

Merging cells can lead to calculation errors in formulas used in the spreadsheet.

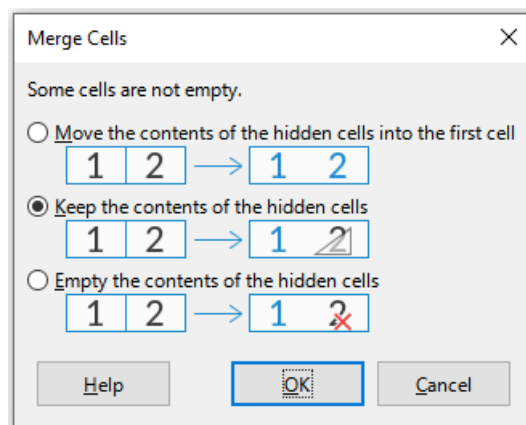

Figure 85: Merge choices for non-empty cells

Splitting cells

You can split a cell that was created from several cells by:

- 1) Selecting a merged cell.

- 2) Going to **Format > Merge Cells > Unmerge Cells** on the Menu bar, or right-clicking and selecting **Unmerge Cells** in the context menu, or clicking on the **Unmerge Cells** icon on the Formatting toolbar.

Any data in the cell will remain in the first cell. If the hidden cells did have any contents before the cells were merged, then you have to manually move the contents in to the correct cell.

Formatting numbers

Calc allows you to apply number formats by using icons on the Formatting toolbar. Select the cell, then click the relevant icon to change the number format.

For more control or to select other number formats, use the *Numbers* tab of the Format Cells dialog (Figure 74):

- Apply any of the data types in the *Category* list to the data.
- Select one of the predefined formats in the *Format* list.
- Control the number of decimal places and leading zeroes in the *Options* area.
- Enter a custom format code.
- The *Language* setting controls the local settings for the different formats such as the date format and currency symbol.

Some number formats are available on the sidebar's Number Format panel of the Properties deck. Click the **More Options** button to open the Format Cells dialog.

Formatting fonts and text in cells



Tip

For consistency in a spreadsheet, use cell styles whenever possible.

To manually select a font and format text for use in a cell:

- 1) Select a cell or cell range.
- 2) To change the font: click the arrowhead icon to the right of the *Font Name* box on the Formatting toolbar and select a font in the drop-down menu. A font is temporarily applied on selected cells by hovering or navigating in this menu. The font can also be changed using the *Font* tab of the Format Cells dialog or the Character panel on the Properties deck of the Sidebar.
- 3) To change the font size: click the arrowhead icon to the right of the *Font Size* box on the Formatting toolbar and select a font size in the drop-down menu. The font size can also be changed using the *Font* tab of the Format Cells dialog or the Character panel on the Properties deck of the Sidebar.
- 4) To change the character format, use one of the following methods:
- 5) Click on the **Bold**, **Italic**, or **Underline** icons on the Formatting toolbar.
- 6) Press *Ctrl+B* (bold), *Ctrl+I* (italic), or *Ctrl+U* (underline) keyboard shortcuts.
- 7) Go to **Format > Text** on the Menu bar and select **Bold**, **Italic**, **Single Underline**, or **Double Underline** in the submenu.
- 8) Click on the **Bold**, **Italic**, or **Underline** icons on the Character panel on the Properties deck of the Sidebar.

- 9) Select **Bold**, **Italic**, or **Bold Italic** in the *Style* menu on the *Font* tab of the Format Cells dialog. Select an entry in the *Underlining* menu on the *Font Effects* tab of the Format Cells dialog.

Additional character format options (including strikethrough and shadowing) are available on the Format Cells dialog and the Sidebar.

To change the horizontal paragraph alignment, do one of the following:

- 1) Click on one of the horizontal alignment icons (**Align Left**, **Align Center**, or **Align Right**) on the Formatting toolbar.
- 2) Press *Ctrl+L* (left), *Ctrl+E* (center), *Ctrl+R* (right), or *Ctrl+J* (justified) keyboard shortcuts.
- 3) Go to **Format > Align Text** on the Menu bar and select **Left**, **Centered**, **Right**, or **Justified** in the submenu.
- 4) Click on the **Align Left**, **Align Center**, **Align Right**, or **Justified** icons on the Alignment panel of the Properties deck on the Sidebar.
- 5) Select **Left**, **Center**, **Right**, **Justified**, **Filled**, or **Distributed** in the *Horizontal* menu on the *Alignment* tab of the Format cells dialog.

To change the vertical paragraph alignment, do one of the following:

- 1) Click on one of the vertical alignment icons (**Align Top**, **Center Vertically**, **Align Bottom**) on the Formatting toolbar.
- 2) Go to **Format > Align Text** on the Menu bar and select **Top**, **Center**, or **Bottom** in the sub-menu.
- 3) Click on the **Align Top**, **Center Vertically**, or **Align Bottom** icons on the Alignment panel of the Properties deck on the Sidebar.
- 4) Select **Top**, **Middle**, **Bottom**, **Justified**, or **Distributed** in the *Vertical* menu on the *Alignment* tab of the Format cells dialog.

To change the font color, do one of the following:

- 1) Click the arrowhead icon to the right of the **Font Color** icon on the Formatting toolbar and select the desired color from the palette. If you want to apply the active (last used) color again, then simply click the main body of the **Font Color** icon.
- 2) Click the arrowhead icon to the right of the **Font Color** icon on the Character panel on the Properties deck of the Sidebar, and select the desired color from the palette. If you want to apply the active (last used) color again, then simply click the main body of the **Font Color** icon.
- 3) Click the *Font color* option on the *Font Effects* tab of the Format Cells dialog and select the desired color from the palette.

To specify the language used in the cell, use the *Language* menu provided on the *Font* tab on the Format Cells dialog.

Use the *Font Effects* tab on the Format Cells dialog to set other font characteristics.

Formatting cell borders

If you want to include borders around a cell or group of cells, use one of the following methods:

Method 1

- 1) Select a cell or range of cells.

- 2) To include borders around the selected cell(s), click the **Borders** icon on the Formatting toolbar or the corresponding control on the Cell Appearance panel in the Properties deck of the Sidebar.
- 3) To select the line style of the borders, click the **Border Style** icon on the Formatting toolbar or the corresponding control on the Cell Appearance panel in the Properties deck of the Sidebar.
- 4) To select a color for the borders, click the **Border Color** icon on the Formatting toolbar to apply the most recently selected color. Alternatively, click the arrowhead to the right of the **Border Color** icon on the Formatting toolbar or click the **Border Color** icon on the Cell Appearance panel in the Properties deck of the Sidebar, and then select the required color from the displayed palette.

Method 2

- 1) Select a cell or range of cells.
- 2) Access the Format Cells dialog (Figure 74).
- 3) For more flexibility in defining border characteristics, including padding and shadow styles, use the *Borders* tab on the Format Cells dialog.

See Chapter 5, Using Styles and Templates, in the *Calc Guide* for more information.

Note

Cell border properties apply only to the selected cells and can be changed only when you are editing those cells. For example, if cell C3 has a top border, that border can only be removed by selecting C3. It cannot be removed in C2 despite also appearing to be the bottom border for cell C2.

Formatting cell background

To change the background color for one or more selected cells, do one of the following:

- Click the arrowhead icon to the right of the **Background Color** icon on the Formatting toolbar and select the desired color from the palette. If you want to apply the active (last used) color again, then simply click the main body of the **Background Color** icon.
- Click the **Background Color** icon on the Cell Appearance panel on the Properties deck of the Sidebar, and select the desired color from the palette.
- Click the **Color** button on the *Background* tab of the Format Cells dialog and then select the desired color from the palette below.

See Chapter 5, Using Styles and Templates, in the *Calc Guide* for more information.

Formatting default cell styles

Several predefined cell styles are supplied with Calc. In addition, you can create custom cell styles by doing one of the following:

- Go to **Styles > New Style from Selection** on the Menu bar, enter a name for the new style, and click the **OK** button.
- Select the **Cell Styles** icon on the Styles deck of the Sidebar and then click the **New Style from Selection** icon on that deck. Enter a name for the new style and click the **OK** button.
- Select the **Cell Styles** icon on the Styles deck of the Sidebar. Right-click a style on that deck and select **New** in the context menu. On the *General* tab of the Cell Style dialog, enter a name for the new style in the *Name* field and click the **OK** button.

You can apply any cell style to selected cells using the *Cell Styles* tab of the Styles deck. In addition, you can apply predefined cell styles using options in the **Styles** menu on the Menu bar. Through the Styles deck, you can modify any cell style or delete any custom cell style. It is not possible to delete predefined cell styles.

Using AutoFormat on cells

Using AutoFormat

You can use Calc's AutoFormat feature to format a table (range of cells) quickly and easily. All formatting applied is direct formatting – cell styles are not used.

- 1) Select the cells in at least three columns and rows, including column and row headers, that you want to format.
- 2) Go to **Format > AutoFormat Styles** on the Menu bar to open the AutoFormat dialog (Figure 86).
- 3) Select the type of format and format color in the list.
- 4) Select the formatting properties to be included in the AutoFormat style. Click **OK**.

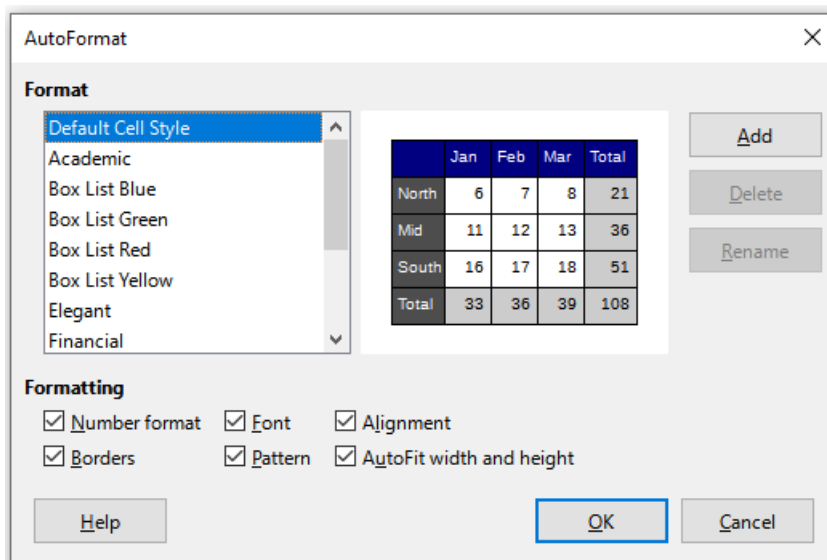

Figure 86: AutoFormat dialog

Defining a new AutoFormat

You can define a new AutoFormat so that it becomes available for use in all spreadsheets.

- 1) Format the data type, font, font size, cell borders, cell background, and so on for a range of cells.
- 2) Select the range, of at least 4x4 cells.
- 3) Go to **Format > AutoFormat Styles** to open the AutoFormat dialog. Click **Add**.
- 4) In the *Name* box of the Add AutoFormat dialog that opens, type a meaningful name for the new format.
- 5) Click **OK** to save. The new AutoFormat is now available in the *Format* list on the AutoFormat dialog.

Note

The new AutoFormat is stored in your computer user profile and is not available to other users. However, you can use it in other spreadsheets. Other users can import the new AutoFormat by selecting a common style from a table range in the spreadsheet and defining it as a new AutoFormat.

Using themes

Spreadsheet themes

Calc comes with a predefined set of formatting themes (set of styles) that can be applied to spreadsheets. You cannot add new themes to Calc, but you can modify a theme's styles after the theme is applied to the spreadsheet. All modified styles are only available for use in that spreadsheet.

To apply a theme to a spreadsheet:

- 1) Go to **Format > Spreadsheet Theme** on the Menu bar or click the **Spreadsheet Theme** icon on the Tools toolbar to open the Theme Selection dialog (Figure 87).
- 2) Select the theme that you want to apply. The theme styles are immediately visible on the underlying spreadsheet.
- 3) Click **OK**.

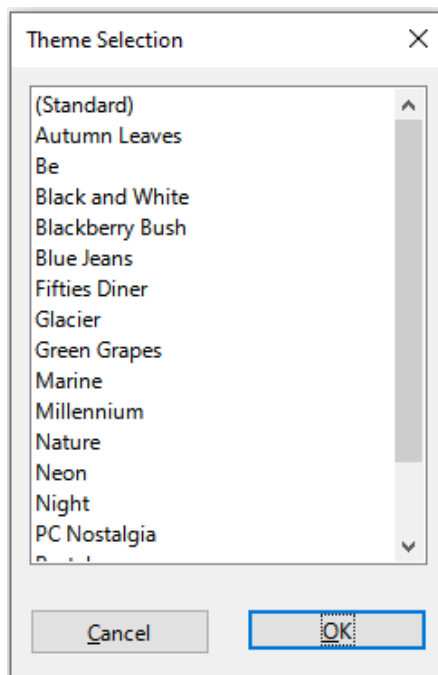

Figure 87: Theme Selection dialog

Selecting a spreadsheet theme adds several new cell styles to the spreadsheet and modifies the *Default* cell style.

If you wish, you can now open the Styles deck on the Sidebar to modify specific styles. These changes do not modify the theme; they only change the appearance of the style in the specific spreadsheet you are using. For more about modifying styles, see Chapter 4, Working with Styles, Templates, and Hyperlinks.

! Caution

Applying a new theme over an existing one will override all existing theme styles customization with the new theme styles.

Document themes

Document themes collect various format selections into a set that can be applied and changed quickly. Theme colors were implemented in LibreOffice 7.6; font and format settings are planned for later releases.

Calc supplies several sets of theme colors, and you can define other sets. Theme colors have names like *Dark 1*, *Light 2*, *Accent 3*, and so on. They can be used in styles or applied manually.

To set up a spreadsheet to use themes, choose colors for fonts, backgrounds, or objects from the *Theme colors* palette (Figure 88), not an ordinary color palette. The first row of the palette contains the theme colors, with other rows containing modifications. For example, the top-left color in the palette is the currently selected theme's *Dark 1* color; the leftmost color in the second row is a 50% lighter version of *Dark 1*; the entry at the intersection of the second column and third row is a 15% darker version of *Light 1*; and so on. You can hover the pointer over any palette cell to see a tooltip indicating the detail of that color.

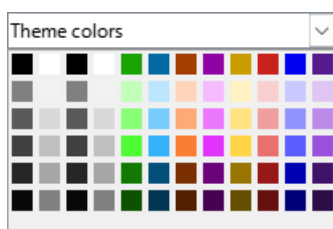

Figure 88: A palette of theme colors

To change the set of theme colors, choose **Format > Theme** on the Menu bar and select a different theme on the Theme dialog (Figure 89). Colors defined as theme colors change in the document. You need not change any style and need not change any object individually.

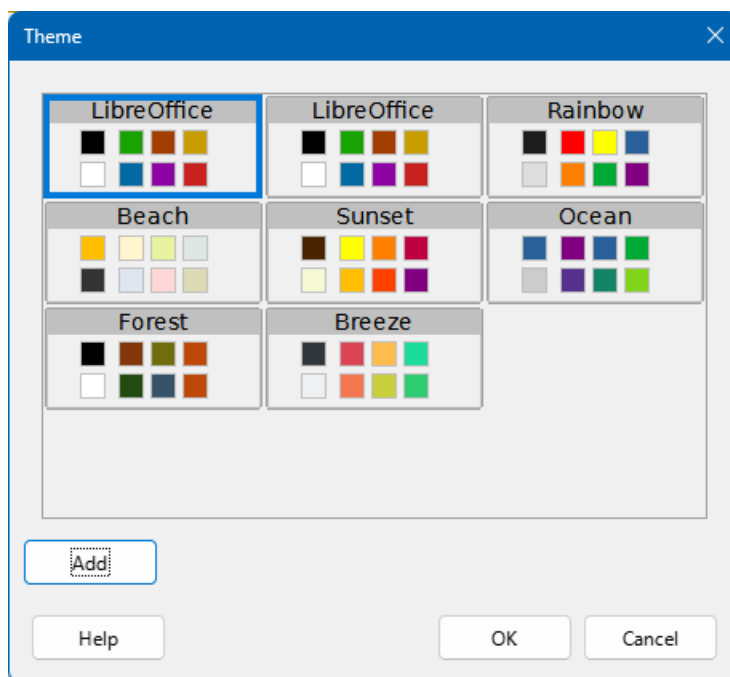

Figure 89: Theme dialog

For more information, see Chapter 5, Using Styles and Templates, in the *Calc Guide*.

Using conditional formatting

Calc can change cell formats depending on user-specified conditions, and those conditions can be imposed in a specified order. For example, a table can show all the values above a specific average in green and all those below that average in red. Conditional formatting also allows you to add graphic icons and data bars to the cell background.

Conditional formatting depends upon the use of styles, and the AutoCalculate feature (**Data > Calculate > AutoCalculate**) must be enabled. See Chapter 4, Formatting Data, in the *Calc Guide* for details.

Filtering data

A filter is a tool that hides or displays records within a sheet based on a set of filtering conditions. Similar to sorting, filters are useful for narrowing down long lists of data in order to find particular data items. In Calc, three types of filter exist:

AutoFilter – the most straightforward filter type, providing access to a combo box through arrowhead buttons located at the top of one or more data columns. This box provides options for basic sorting (ascending and descending); sorting by background or font color; filtering by background or font color; filtering by condition (empty, not empty, top 10, and bottom 10); and others.

Standard filter – more complex than AutoFilters, allowing for up to eight filter conditions. Powerful filters can be set up using regular expressions. Also, unlike AutoFilters, standard filters use a dialog to define the conditions.

Advanced filter – filter conditions are stored in a sheet rather than entered into a dialog.

Setting up and using filters are explained in Chapter 2, Entering and Editing Data, in the *Calc Guide*.

Cell protection

Cells can be password-protected to prevent unauthorized users from making changes. Protected cells can optionally be hidden. Use the *Cell Protection* tab of the Format Cells dialog (Figure 90) to set up cell protection and toggle the hidden status of protected cells.

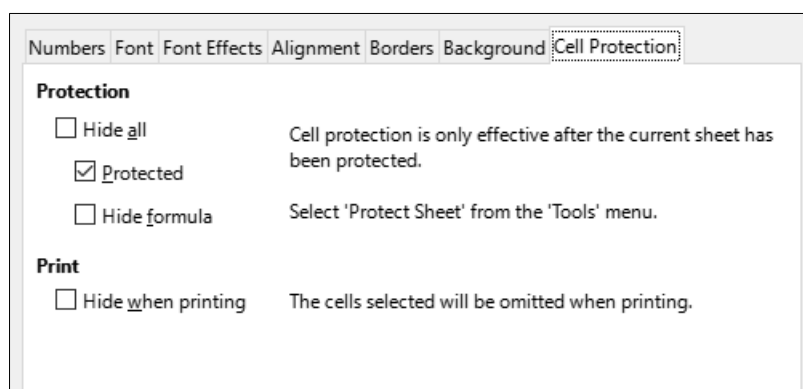

Figure 90: Cell Protection tab in Format Cells dialog

Once all desired cells have been flagged with either a protected or unprotected status:

- 1) Go to **Tools > Protect Sheet**, or right-click on the sheet's tab and select **Protect Sheet** in the context menu. The Protect Sheet dialog opens (Figure 91).
- 2) Select **Protect this sheet and the contents of protected cells**.

- 3) Type a password and then confirm the password. The dialog provides a password strength meter to indicate the strength of the entered password. This incorporates a colored bar to reflect password strength, with red indicating a weak password and green indicating a strong password. In addition, the longer the colored bar, the greater the strength of the password.
- 4) Select or deselect the elements to protect from user actions.
- 5) Click **OK**.

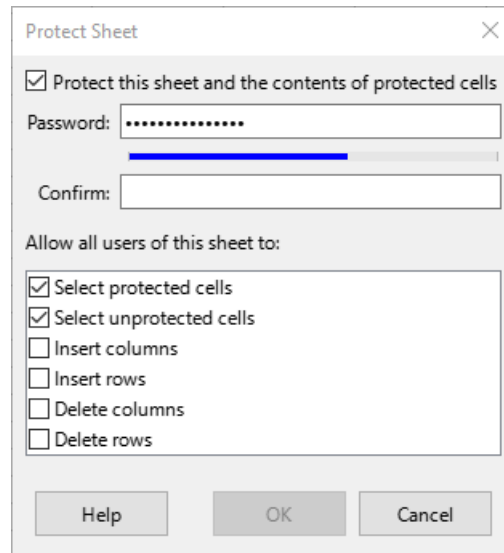

Figure 91: Protect Sheet dialog with password strength meter

Any cells that had been marked as protected will no longer be editable by anyone that does not have the password.

The protected sheet has a padlock icon in its tab, as shown in Figure 92.

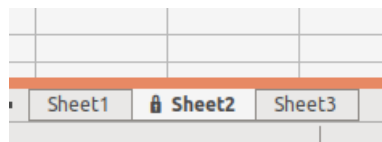

Figure 92: The padlock icon in a protected sheet

Alternatively, the entire spreadsheet can be password-protected by selecting **Tools > Protect Spreadsheet Structure** on the Menu bar. When this option is chosen, unauthorized users cannot add, delete, move, or rename any sheets in the document.

Sorting records

When Calc sorts cells in a sheet, they are re-ordered based on user-specified sort criteria. Sorts are useful when you are searching for a particular item and become even more useful after you have filtered data.

Also, sorting allows you to add new information to the bottom of your spreadsheet and then use a sort to put the values in their proper order. When a spreadsheet is long, it is usually easier to add new information at the bottom of the sheet, rather than adding rows in their correct place. After you have added information, you can then sort the records to update the spreadsheet.

For more information on sorting records and the sorting options available, see Chapter 2, Entering and Editing Data, in the *Calc Guide*.

To use the Sort dialog on cells in a spreadsheet:

- 1) Select the cells to be sorted.
- 2) Go to **Data > Sort** on the Menu bar, or click the **Sort** icon on the Standard toolbar, to open the Sort dialog (Figure 93).
- 3) On the *Sort Criteria* tab, select the sort criteria in the drop-down lists. The selected lists are populated from the selected cells.
- 4) Select either ascending order (A-Z, 0-9) or descending order (Z-A, 9-0).
- 5) Adjust the settings as required on the *Sort Criteria* and *Options* tabs. For details, see the Help or Chapter 2, Entering and Editing Data, in the *Calc Guide*.
- 6) Click **OK** and the sort is carried out on the spreadsheet.

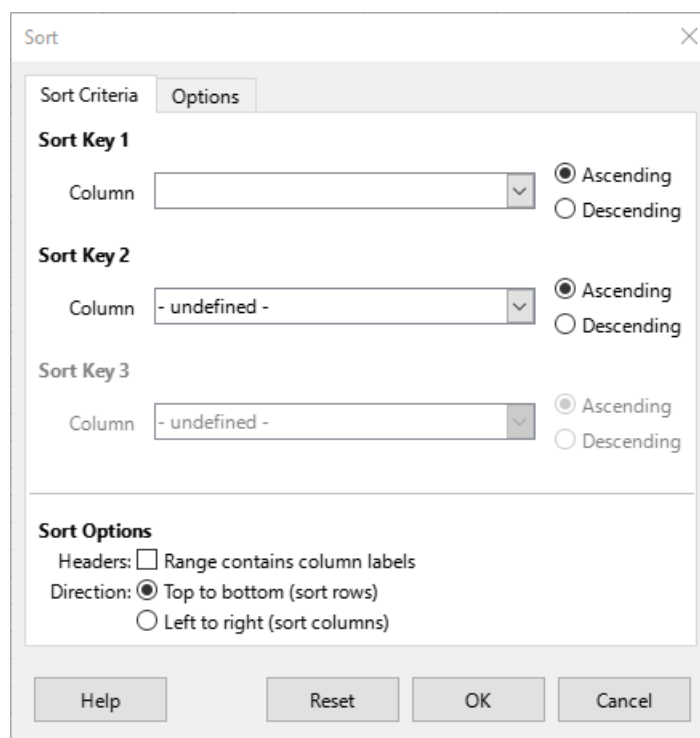

Figure 93: Sort dialog, Sort Criteria tab

Cell comments

Users can add a comment to a cell. These comments are small notes and text that provide extra information about the spreadsheet. They are not considered a part of the spreadsheet for calculation or printing purposes, and usually only appear when the user hovers the mouse over the particular cell that has been commented.

You can insert a comment by any of the following actions:

- Right-clicking on the desired cell and selecting **Insert Comment** in the context menu.
- Selecting **Insert > Comment** on the Menu bar.
- Pressing *Ctrl+Alt+C*.
- Clicking the **Insert Comment** icon on the Standard toolbar.

Cells that contain comments are marked with a colored triangle in the upper right corner. By default, comments will remain hidden and only appear when you hover the mouse over a cell

that contains a comment. To toggle the visibility of comments, select **View > Comments** on the Menu bar.

For more information, see Chapter 12, Sharing and Reviewing Spreadsheets, in the *Calc Guide*.

Using formulas and functions

You may need more than numbers and text in a spreadsheet. Often the contents of one cell depend on the contents of other cells. Formulas are equations that use numbers and variables to produce a result. Any cell can contain a formula. Variables are placed in cells to hold data required by equations.

A function is a predefined calculation entered in a cell to help you analyze or manipulate data. All you have to do is enter the arguments and the calculation is made automatically. Functions help you create the formulas required to get the results that you are looking for.

Creating formulas

Functions and formulas can be entered directly into the Formula bar or by using the Function Wizard. To launch the Function Wizard, click the **Function Wizard** icon on the Formula bar, select **Insert > Function** on the Menu bar, or press *Ctrl+F2*.

Inside the Function Wizard, you can choose from the many built-in Calc functions available. When you search for a term in the Function Wizard, function descriptions are provided as well as their names. You can also choose to complete functions from within the wizard rather than having to type full formulas into the Formula bar.

Each function, when selected, will display a brief explanation of its use and acceptable syntax. It will also allow you to enter the information required by that function and a result window will showing the expected calculation from the data entered.

Note

A fast alternative to the Function Wizard is the Functions deck on the Sidebar, where you can quickly list and narrow down functions. It provides brief explanations on their use and syntax, but does not provide the search or data entry capabilities of the full wizard.

Calc offers powerful built-in functions under multiple categories, covering Database, Date & Time, Financial, Information, Logical, Mathematical, Array, Statistical, Spreadsheet, Text, and Add-in functions.

For a more in-depth introduction to formulas and the Function Wizard, see Chapter 8, Using Formulas and Functions, in the *Calc Guide*.

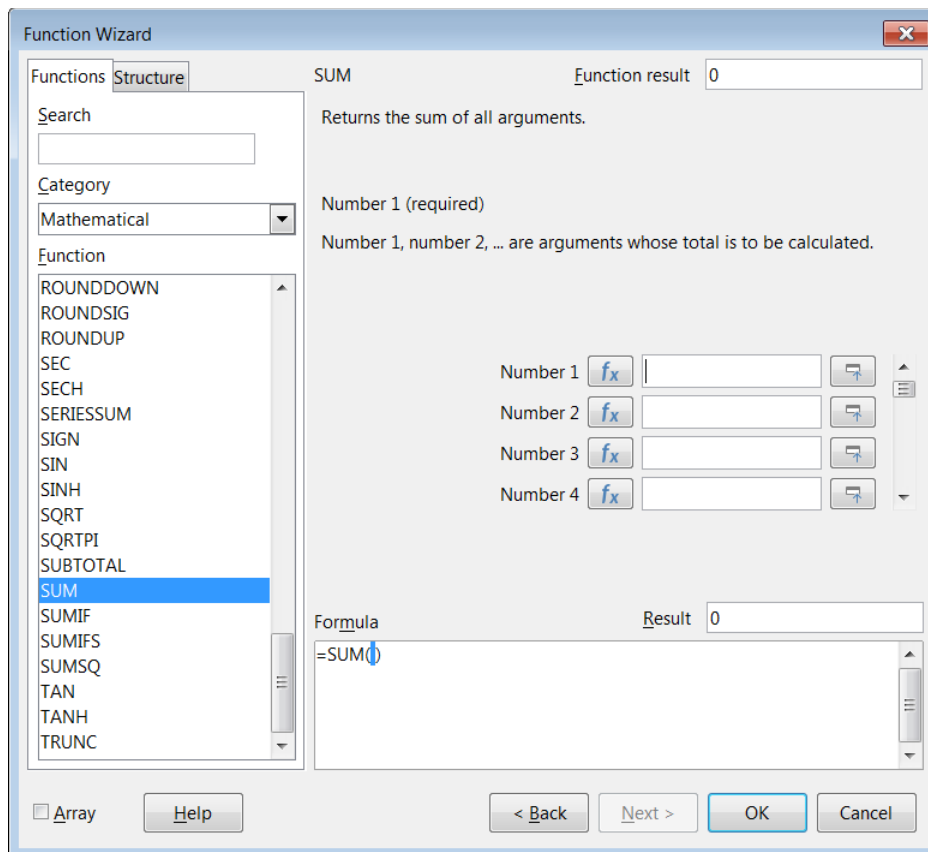

Figure 94: Function Wizard

Analyzing data

Calc includes many tools to help you analyze information, including features for copying and reusing data, for automatically creating subtotals, and other ways to vary information and help you find the answers you need. These tools are divided between the Tools and Data menus.

Calc also includes many tools for statistical analysis, and they can help you obtain important numerical information on data obtained from physical measurements, polls, or even business transactions such as sales, stock quotations, and so on. These statistical data analyses are available in the menu **Data > Statistics**.

See Chapter 10, Data Analysis, in the *Calc Guide* for more information on the these tools.

Pivot tables and pivot charts

One of the most useful tools for analyzing data is the pivot table, which allows you to organize, manipulate, and summarize large amounts of data to make it much easier to read and understand. They also allow you to answer different questions about a spreadsheet by rearranging – or pivoting – the data in it, which includes the ability to view different summaries of the source data, display the details of areas of interest, and create reports. You can also create a pivot chart that allows you to view a graphical representation of the data in a pivot table.

For example, you might have a spreadsheet containing a list of donations to various charities by a group of recruiters in various months, but you are only interested in how much money each recruiter has collected in total. Instead of manually calculating that amount by using the sorting and formatting options, you could arrange a pivot table which makes that data easier to organize and read.

To create a pivot table, choose **Data > Pivot Table > Insert or Edit** on the Menu bar, or click the **Insert or Edit Pivot Table** icon on the Standard toolbar. The Pivot Table Layout dialog will intelligently guess the column headings from the provided raw data and insert them into the *Available Fields* selection box. From there, you can drag and drop your desired information into column, row, data, or filter fields to organize accordingly and click **OK** to view the results.

To choose new information to display, or to alter the layout of the existing information, right-click anywhere in the existing pivot table to bring up the context menu and choose **Properties**. You can also access the same dialog by selecting **Data > Pivot Table > Insert or Edit** on the Menu bar, or clicking the **Insert or Edit Pivot Table** icon on the Standard toolbar.

For an in-depth explanation of pivot tables and the preconditions necessary to use them, see Chapter 9, Using Pivot Tables, in the *Calc Guide*.

Pivot charts

To get a quick visual representation of the data contained in a pivot table, you can generate a pivot chart. Functionally, pivot charts are nearly identical to regular charts except in two key areas. First, as the data in the pivot table is altered, the pivot chart will adjust itself automatically. Second, a pivot chart includes field buttons, which are graphical elements that allow you to filter the content of the pivot table from within its pivot chart.

For more information on pivot charts and charts in general, see Chapter 3, Creating Charts and Graphs, and Chapter 9, Using Pivot Tables, in the *Calc Guide*.

Printing

Printing from Calc is similar to printing from other LibreOffice components (see Chapter 1, LibreOffice Basics), but some details of printing in Calc are different, especially regarding preparation for printing.

After print ranges have been defined, they are formatted with automatic page breaks. To view the page breaks, go to **View > Page Break** on the Menu bar.

Print ranges

Print ranges can be used to print a specific part of the data and print selected rows or columns on every page. For more information about using print ranges, see Chapter 7, Printing, Exporting, Emailing, and Signing in the *Calc Guide*.

Defining a print range

To define a new print range or modify an existing print range:

- 1) Select the range of cells to be included in the print range.
- 2) Go to **Format > Print Ranges > Define** on the Menu bar. Automatic page break lines are displayed on screen.
- 3) To check the print range, go to **File > Print Preview** on the Menu bar, press *Ctrl+Shift+0*, or click the **Toggle Print Preview** icon on the Standard toolbar. Calc will display only the cells in the print range.

Adding to a print range

After defining a print range, you can add more cells to it by creating another print range. This allows multiple, separate areas of the same sheet to be printed while not printing the whole sheet.

- 1) After defining a print range, select an extra range of cells for adding to the print range.

- 2) Go to **Format > Print Ranges > Add** on the Menu bar to add the extra cells to the print range. The page break lines are no longer displayed on the screen.
- 3) To check the print ranges, go to **File > Print Preview** on the Menu bar, press *Ctrl+Shift+O*, or click the **Toggle Print Preview** icon on the Standard toolbar. Calc will display the print ranges as separate pages.

Note

The additional print range will print as a separate page, even if both ranges are on the same sheet.

Removing a print range

It may become necessary to remove a defined print range, for example, if the whole sheet needs to be printed later.

To remove all the defined print ranges, go to **Format > Print Ranges > Clear** on the Menu bar. After the print ranges have been removed, the default page break lines will appear on the screen.

Editing a print range

At any time, you can directly edit the print range, for example to remove or resize part of the print range. Go to **Format > Print Ranges > Edit** on the Menu bar to open the Edit Print Ranges dialog where you can modify the print range.

Printing options

To select the options for page order, elements to be printed, and scale to be used when printing a spreadsheet:

- 1) Go to **Format > Page Style** on the Menu bar to open the Page Style dialog (Figure 95).
- 2) Select the *Sheet* tab and make your selections from the available options. Click **OK**.

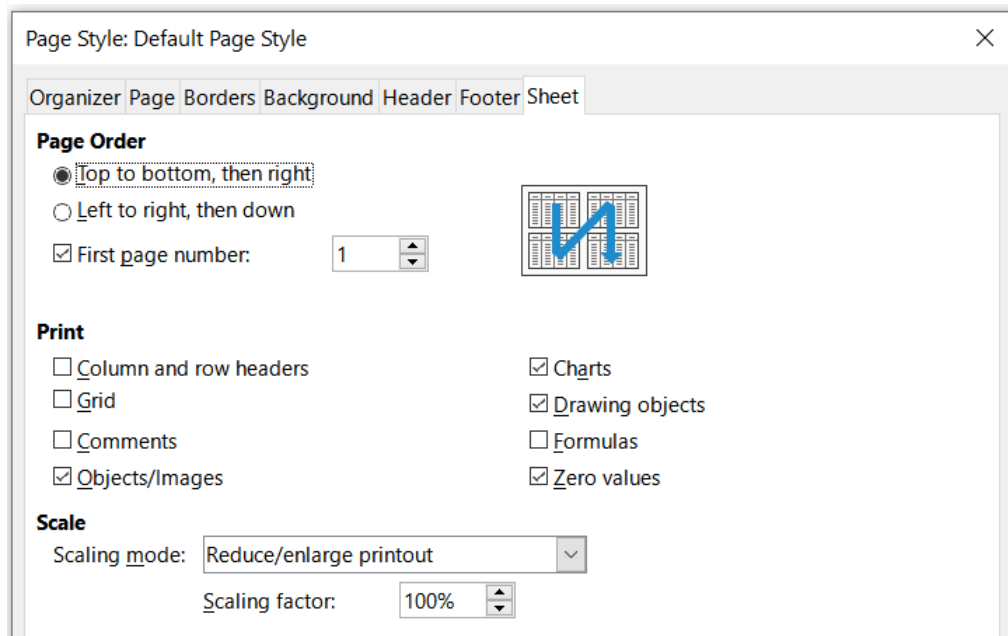

Figure 95: Page Style dialog – Sheet tab

Repeat printing of rows or columns

If a sheet is printed on multiple pages, you can set up certain rows or columns to repeat on each printed page. For example, if the top two rows of the sheet as well as column A need to be printed on all pages, do the following:

- 1) Go to **Format > Print Ranges > Edit** on the Menu bar to open the Edit Print Ranges dialog (Figure 96).
- 2) Type the row identifiers in the *Rows to Repeat* box. For example, to repeat rows 1 and 2, type \$1:\$2. This automatically changes *Rows to Repeat* from **- none -** to **- user defined -**.
- 3) Type the column identifiers in the *Columns to Repeat* box. For example, to repeat column A, type \$A. In *Columns to Repeat*, **- none -** changes to **- user defined -**.
- 4) Click **OK**.

For more information on editing print ranges, see Chapter 7, Printing, Exporting, Emailing, and Signing, in the *Calc Guide*.

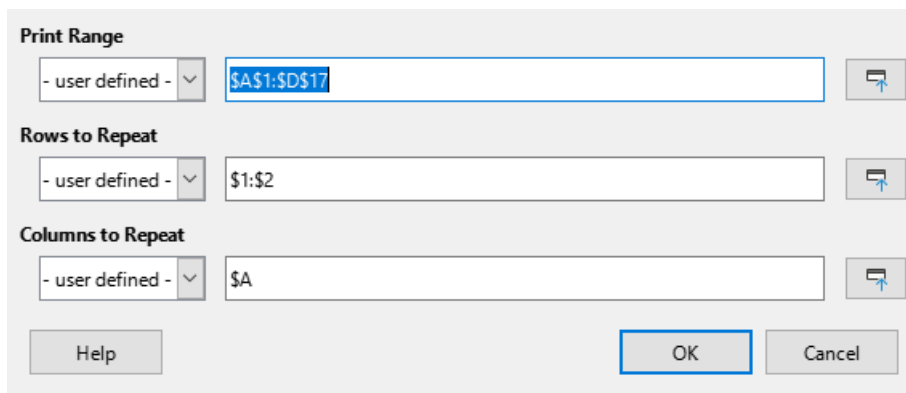

Figure 96: Edit Print Ranges dialog

Page breaks

While defining a print range can be a powerful tool, it may sometimes be necessary to manually adjust the printout using a manual page break. A page break helps to ensure that the data prints properly according to the page size and page orientation. You can insert a horizontal page break above or a vertical page break to the left of the active cell.

Inserting a break

To insert a page break:

- 1) Navigate to the cell where the page break is needed.
- 2) Go to **Sheet > Insert Page Break** on the Menu bar.
- 3) Select **Row Break** to create a horizontal page break above the selected cell or select **Column Break** to create a vertical page break to the left of the selected cell.

Tip

After selecting **View > Page Break**, you can right-click on a cell to access a context menu containing **Row Break** and **Column Break** options.

Deleting a break

To remove a page break:

- 1) Navigate to a cell that is next to the page break you want to remove.
- 2) Go to **Sheet > Delete Page Break** on the Menu bar.
- 3) Select **Row Break** or **Column Break** as needed.



Tip

Multiple manual row and column breaks can exist on the same sheet. When you want to remove them, you can remove each break individually, as described above. However, after selecting **View > Page Break**, you can right-click on a cell to access a context menu containing a **Delete All Breaks** option to remove them all at once.

For more information on page breaks, see Chapter 7, Printing, Exporting, Emailing, and Signing, in the *Calc Guide*.

Headers and footers

Headers and footers are text that can be printed at the top or bottom of a page when you print a spreadsheet. Headers and footers are set and defined using the same method. For more information on setting and defining headers and footers, see Chapter 7, Printing, Exporting, Emailing, and Signing, in the *Calc Guide*.

Headers and footers are also assigned to a page style. You can define more than one page style for a spreadsheet and assign different page styles to different sheets within a spreadsheet. For more information, see Chapter 5, Using Styles and Templates, in the *Calc Guide*.

Setting a header or footer

To set a header or footer:

- 1) Select the sheet that you want to set the header or footer for.
- 2) Open the Page Style dialog (Figure 97) using one of the following methods:
- 3) Go to **Format > Page Style** on the Menu bar.
- 4) On the Styles deck of the Sidebar, right-click the relevant page style and select **Modify** in the context menu.
- 5) Double-click the name of the page style on the Status Bar.
- 6) Select the *Header* or *Footer* tab as appropriate.
- 7) Select the **Header on** or **Footer on** option.
- 8) Select **Same content on left and right pages** if you want the same header or footer to appear on all the printed pages.
- 9) Select / deselect **Same content on first page** as required.
- 10) Set the margins, spacing, and height for the header or footer. You can also select **AutoFit height** to automatically adjust the height of the header or footer.
- 11) To change the appearance of the header or footer, click on **More** to open the Border / Background dialog.
- 12) To set the contents, for example page number, date and so on, that appear in the header or footer, click **Edit** to open the Headers (or Footers) dialog.
- 13) Click **OK** to save your changes.

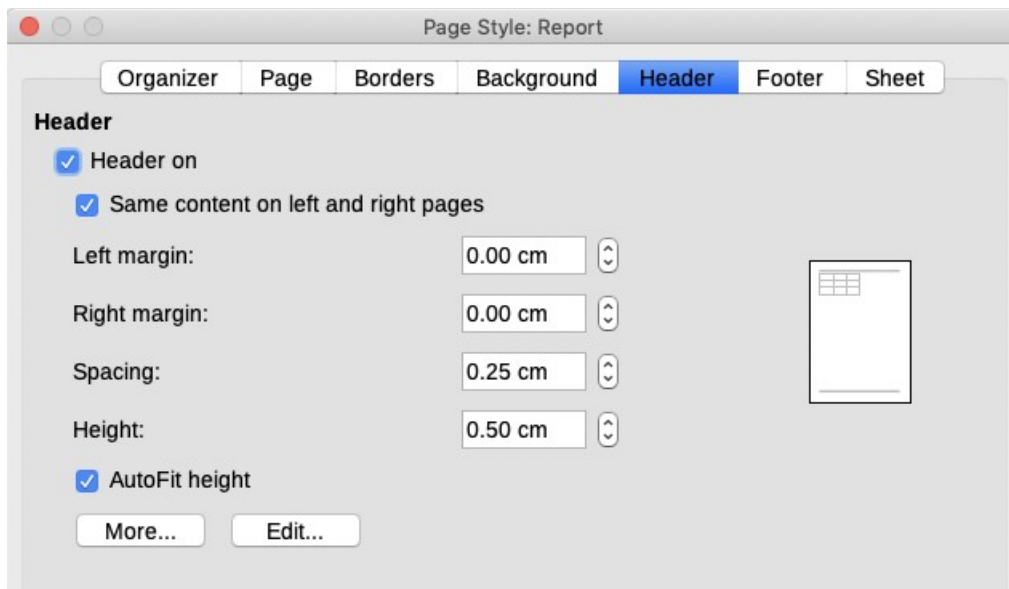

Figure 97: Header tab of Page Style dialog



LibreOffice
Community



Chapter 4, Working with Styles, Templates, and Hyperlinks

Using consistent formatting in documents

Introduction

To ensure formatting consistency in LibreOffice documents, users can control text and other elements by using templates, styles and direct formatting. Direct formatting is also known as manual formatting. Understanding how to format documents unlocks the power of LibreOffice.

Styles

A style in LibreOffice is a collection of formatting attributes that can be applied to text and other objects. If text or object shares a style in LibreOffice, then that text or object shares the chosen attributes of that style. For example, a paragraph style can include settings such as font type and size, indents, spacing between lines, alignment on a page, and so on.

All LibreOffice installations share a default set of styles that cannot be deleted, but can be modified to suit the user's formatting requirements. Also, new styles can be created and these styles can be deleted.

Templates

A template is a document that allows users to generate new documents that has pre-existing contents and a set of specific formatting styles, graphics, tables, objects, and so on. Templates are used as a basis for creating several similar documents for company documents, or user guides. For example, define paragraph and character styles in a document, then save the document as a template. Then the command **New > Templates...** can be used to create a new document with the same look and feel of that template.

New documents created in LibreOffice use a default template that is hard coded into LibreOffice. This default template can be changed to suit personal or corporate requirements.

When LibreOffice is installed on a computer, a number of predefined templates are also installed, providing a starting point for different types of documents, such as business letters, presentations, or drawings.

Direct (or manual) formatting

Applies formatting directly, or manually, to selected text. For example, select a word, then click on a tool on the Formatting toolbar, the Sidebar, or use a keyboard shortcut to format the text as bold or italic. However, using direct formatting can produce documents with a mismatch of formatting attributes.

Styles

Working with styles

A style allows you to apply a set of common formatting elements to pages, text, frames, cells, graphic objects, and so on. Each style has a name such as "Body Text" and "Document Title." Using styles can quickly change the format, or appearance, of selected elements.

If you do not use styles and manually format paragraphs, words, tables, page layouts, and other elements in documents, this can increase user workload and introduce format errors into a document. Styles provide consistency in documents. LibreOffice recommend the use of styles to reduce the workload and increase the accuracy of producing good documents with ease.

Since LibreOffice styles may work differently from other office software programs, some planning may be needed, but that effort will save time and effort over the longer term. Also, Writer relies on heading styles (or other styles if specified) when compiling a table of contents.

 **Note**

Manual formatting overrides any applied styles and once an element has been formatted manually, it cannot be modified by a style. To remove direct formatting, select the text, then right-click and select **Clear Direct Formatting** from the context menu. Alternatively, use the keyboard shortcut *Ctrl+M* (macOS +M) to clear direct formatting from selected text, or go to **Format > Clear Direct Formatting** on the Menu bar.

Style categories

See Table 8 on which style categories are available for each module. For more information, see the specific user guide for each LibreOffice module. All the styles are defined as:

Page styles

Controls margins, headers and footers, borders and backgrounds. In Calc, page styles also define the sequence for printing sheets.

Paragraph styles

Controls all the formatting elements of a paragraph, such as text alignment, tab stops, line spacing, and borders, and can include character formatting.

Character styles

Affects the formatting of text within a paragraph, such as the font and size of text, or modifies elements such as bold and italic.

Table styles

Apply predefined formats to tables and table elements in a text document.

Frame styles

Format graphic and text frames, including text wrap, borders, backgrounds, and columns.

List styles

Allows selection of format and positioning of numbers or bullets in lists.

Cell styles

Format cell data, such as fonts, alignment, borders, background, number formats (for example, currency, date, number), and cell protection.

Drawing styles

Format drawings and presentations, such as line, area, shadowing, transparency, font, connectors, dimensioning, and other attributes.

Presentation styles

Format font, indents, spacing, alignment, and tabs.

Table 8: Style categories available in LibreOffice modules

Style Category	Writer	Calc	Draw	Impress
Page	Yes	Yes		
Paragraph	Yes			
Character	Yes			
Frame	Yes			
List	Yes			
Table	Yes			
Cell		Yes		

Style Category	Writer	Calc	Draw	Impress
Presentation				Yes
Drawing			Yes	Yes

Style types

See Table 9 on which style types are available for each module. For more information on styles, see the user guide for that LibreOffice module. Generally, the LibreOffice style types are:

Hierarchical

Displays the styles in the selected category in a hierarchical list. To view the styles inside a sub-level, click on the chevron > next to the style name.

All Styles

Displays all styles of the selected style category.

Hidden Styles

Displays the styles that have been hidden in the document. Hiding styles removes, but does not delete, selected styles from the list of displayed styles.

Applied Styles

Displays the styles of the selected category that have been applied in the current document.

Custom Styles

Displays all user-defined styles in the selected style category.

Automatic

Displays styles appropriate to the current context.

Text Styles

Displays formatting styles for text.

Chapter Styles

Displays formatting styles for headings.

List Styles

Displays formatting styles for ordered or unordered lists.

Index Styles

Displays formatting styles for indexes.

Special Styles

Displays formatting styles for headers, footers, footnotes, endnotes, tables, and captions.

HTML Styles

Displays a list of styles for HTML documents.

Conditional Styles

Displays the user-defined conditional styles.

Table 9: Style types available in LibreOffice modules

Style Type	Writer	Calc	Draw	Impress
Hierarchical	Yes	Yes	Yes	Yes
All Styles	Yes	Yes	Yes	Yes
Hidden Styles	Yes	Yes	Yes	Yes
Applied Styles	Yes	Yes	Yes	Yes
Custom Styles	Yes	Yes	Yes	Yes

Style Type	Writer	Calc	Draw	Impress
Automatic	Yes			
Text Styles	Yes			
List Styles	Yes			
Index Styles	Yes			
Special Styles	Yes			
HTML Styles	Yes			
Conditional Styles	Yes			

Applying styles

LibreOffice provides several ways to select and apply styles, as seen below:

- Select the Styles deck in the Sidebar.
- **Use View > Styles** on Menu bar.
- **Select Styles** on the Menu bar (Writer and Calc).
- **Choose Set Paragraph Style** on the Formatting toolbar (Writer).
- **Select Apply Style** on the Formatting toolbar (Calc).
- Right-click to bring up the context menu and select **Character, Paragraph, or List** (Writer).
- Right-click to bring up the context menu and select **Styles** (Calc).
- **Fill Format Mode** in Styles deck on Sidebar (Writer and Calc).
- Keyboard shortcuts where available.

Styles deck on Sidebar

The Styles deck allows you to view all available styles for a document (Figure 98). To access the deck, perform these steps:

- 1) Open the Styles deck on the Sidebar using one of the following methods:
 - Go to **View > Styles** on the Menu bar.
 - For Writer or Calc only, go to **Styles > Manage Styles** on the Menu bar.
 - Use the keyboard shortcut *F11* (macOS $\text{⌘}+T$).
 - Click on **Styles** on the right of the Sidebar.
- 2) To display a preview of styles in the Styles deck, select **Show previews** at the bottom of the Styles deck.
- 3) To select a style category, click on one of the icons at the top of the Styles deck to display the styles available in the selected category. See “Style categories” on page 169 for more information on available style categories for each LibreOffice module.
- 4) To select a style type, click on the drop-down list to open it and select the style type required. The style types available depends on which LibreOffice module is open and the type of document being edited. See “Style types” on page 170 for more information on available style types for each LibreOffice module.

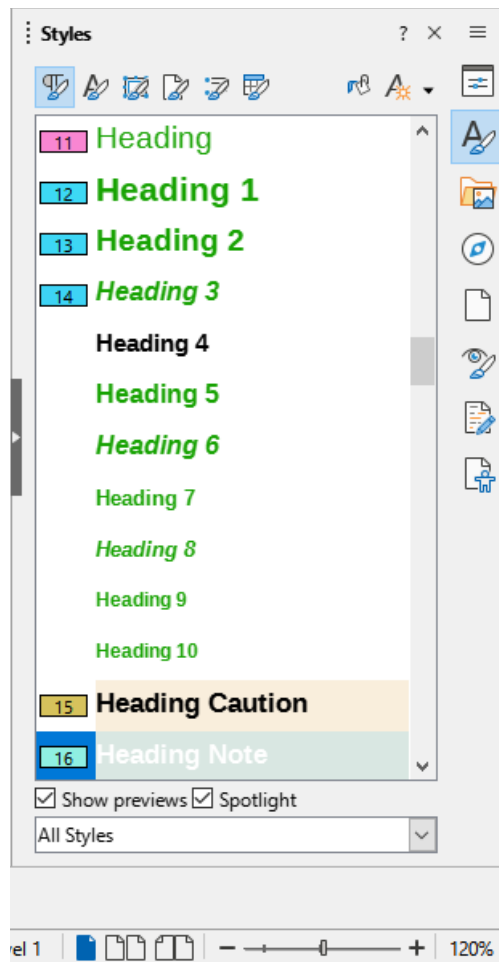

Figure 98: Styles deck on Sidebar — Writer

- 5) To apply a style to an element, position the cursor in text, or select an object, in the document, then double click on the required style in the Styles deck on the Sidebar.

Spotlighting styles

LibreOffice Styles deck on the sidebar also provides a tool to spotlight paragraph and character styles as well as direct formatting present in the document. The Spotlight tool is handy to assist in housekeeping the document with respect to the styles in use and direct formatting. To enable the spotlight feature proceed as follow:

- 1) Open the Styles deck on the Sidebar as indicated above.
- 2) Mark the **Spotlight** checkbox at the bottom of the Styles deck (Figure 98).
 - The paragraph spotlight indicator is codified using numbers and colors displayed in the left margin. They correspond to the numbers and colors displayed in the Styles deck.
 - The character spotlight indicator is codified using number and colors displayed in a call-out. They also correspond to the numbers and colors displayed in the Styles deck.
 - Paragraphs with direct formatting are indicated by a hatch pattern in the Spotlight colored indicators on the margin.

58 **Note**

Manual formatting overrides any applied styles and once an element has been formatted manually, it cannot be modified by a style. To remove direct formatting, **df** select the text, then right-click and select **Clear Direct Formatting** from the context menu. Alternatively, use the keyboard shortcut **Ctrl+M** (macOS **⌘+M**) to clear direct formatting from selected text, or go to **Format > Clear Direct Formatting** on the Menu bar.

131

48 **Style categories**

6 See Table 1 on which style categories are available for each module. For more information, see the specific user guide for each LibreOffice module. All the styles are defined as:

24 **Page styles**

7 Controls margins, headers and footers, borders and backgrounds. In Calc, page styles also define the sequence for printing sheets.

24 **Paragraph styles**

7 Controls all the formatting elements of a paragraph, such as text alignment, tab stops, line spacing, and borders, and can include character formatting.

Figure 99: Spotighting paragraphs and characters styles.

- Characters direct formatting are indicated by a call-out with string "df" next to the text (Figure 99).

Note

Choose **Format > Spotlight > Character Direct Formatting** to activate the character direct formatting visual indicator.

Styles menu

The **Styles** menu is available in LibreOffice's Writer and Calc modules. It displays the default set of styles available in the Styles deck on the Sidebar (Figure 101 for Writer and Figure 100 for Calc). These styles are factory set and available in all LibreOffice installations.

- 1) Locate the text or element where the style will be applied. If necessary, select it.
- 2) Go to **Styles** on the Menu bar.
- 3) Click on the style name to apply its attributes to the selected text, or element.



Figure 100: Style submenu in Calc

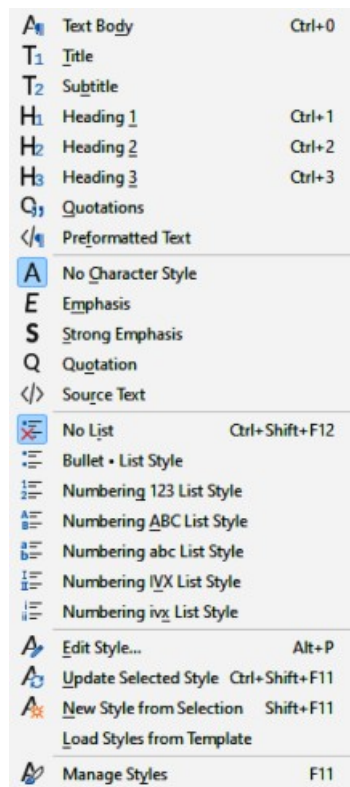

Figure 101: Styles submenu in Writer

Applying styles with the context menu

Writer

This module's context menu can apply styles to selected text. Right-click on text to bring up the context menu. Then select either **Paragraph**, **Character**, or **List** and choose the appropriate style from a sub-context menu.

Calc

In this module, select cells, right-click to bring up the context menu, then select **Styles** to apply a style to those cells.

Formatting toolbar

Writer

If a paragraph style has been created and applied to text, the style name will appear in the **Set Paragraph Style** drop-down list at the left-hand end of the Formatting toolbar.

- 1) Click in a paragraph to select that style.
- 2) Click on **Set Paragraph Style** on the Formatting toolbar to open the drop-down list.
- 3) Select the required paragraph style from the options available in the drop-down list to apply it to the selected paragraph.



Tip

Enable the Formatting (Styles) toolbar in **View – Toolbars** to get the same style commands as the **Styles** menu for Writer.

Calc

After a style has been created in Calc and applied to one or more cells, the style name appears in the **Apply Style** drop-down list at the left-hand end of the Formatting toolbar.

- 1) Click in a cell to select it.
- 2) Click on **Apply Style** on the Formatting toolbar to open the drop-down list.
- 3) Select the required cell style from the options available in the drop-down list to apply it to the selected cell.

Fill Format Mode







If you need to apply a style to multiple elements in the Writer and Calc modules without using the Styles deck and double-clicking, the **Fill Format Mode** is available.

- 1) Open the Styles deck on the Sidebar and select the required style.
- 2) Click on **Fill Format Mode** at the top of the Styles deck and the cursor changes shape to indicate **Fill Format Mode**.
- 3) Position the cursor on the element where a style is going to be applied.
- 4) Click and the style is applied to the selected element. To apply a character style, click and drag to select the characters, then release the cursor.
- 5) Repeat step 4 until the style has been applied to all required elements.
- 6) To quit **Fill Format Mode**, click on **Fill Format Mode** again, or press the *Esc* key.

Keyboard shortcuts

In Writer, keyboard shortcuts can apply paragraph styles to selected paragraphs and also allow users to perform some edits on styles, as shown in Table 100.

Table 10: Paragraph style and style editing keyboard shortcuts

Style name & editing function	Windows & Linux	macOS
Body Text	<i>Ctrl+0</i>	 +0
Heading 1	<i>Ctrl+1</i>	 +1
Heading 2	<i>Ctrl+2</i>	 +2
Heading 3	<i>Ctrl+3</i>	 +3
No List	<i>Ctrl+Shift+F12</i>	 +Shift+F12
Edit Style	<i>Alt+P</i>	 +P
Update Selected Style	<i>Ctrl+Shift+F11</i>	 +Shift+F11
New Style from Selection	<i>Shift+F11</i>	<i>Shift+F11</i>
Manage Styles	<i>F11</i>	<i>F11</i>

Creating new styles

Using a styles dialog

A style can be created with the Styles deck. For more information on creating styles, refer to the guide for that LibreOffice module.

- 1) Open the Styles deck on the Sidebar.
- 2) Click on the icon for the required style category at the top of the Styles deck to open the list of styles available in the style category.

- 3) Right-click on a style and select **New** from the context menu to open a style dialog applicable for the selected style category. Figure 103 shows an example of the Paragraph Styles dialog.
- 4) Click on **General** to open the **General** page in the styles dialog.
- 5) In *Name*, enter a name for the new style.
- 6) For text documents paragraph styles only, select a style from the *Next Style* drop-down list that will be available after you press *Enter* closing a paragraph.
- 7) If necessary, in *Inherit from*, select a style from the drop-down list that will be used for basic formatting of the new style in the document.
- 8) In *Category*, select a style category from the drop-down list that the new style will use. By default, **Custom Styles** is the selected category.
- 9) Use the various options available on the other dialog pages to format the new style to the document requirements. If available, changes to a style can be checked in the preview box on the dialog page.
- 10) When all formatting options have been carried out, click on **OK** to save the new style and close the dialog.

Note

If a style has been selected in *Inherit from* on the dialog **General** page, any formatting changes to this style are also carried out on the new style that is created.

Creating new style from a selection

LibreOffice can use the format of selected text or a selected cell to create a new style. Styles created with this method are only available in the document it was created. Also, those styles will not be included in a template created from that document.

For more information on creating styles with this method, refer to the user guide for the appropriate LibreOffice module.

- 1) Open the Styles deck on the Sidebar if it is not already open (Figure 102).
- 2) Click on the icon for the required style category at the top of the Styles deck to open the list of styles in the style category.
- 3) In the document, select the element to be used as a basis for a new style.
- 4) Create the new style using one of the following steps to open the New Style from Selection dialog:
 - In Writer, click on **Styles actions** on the Sidebar title bar and select **New Style from Selection** from the context menu.
 - In Calc, Draw, or Impress, click on **New Style from Selection**.
- 5) In the New Style from Selection dialog, enter a name for the new style in **Enter new style name** text box.
- 6) Click **OK** to create the new style in the selected style category using the selected formatting options and close the dialog.

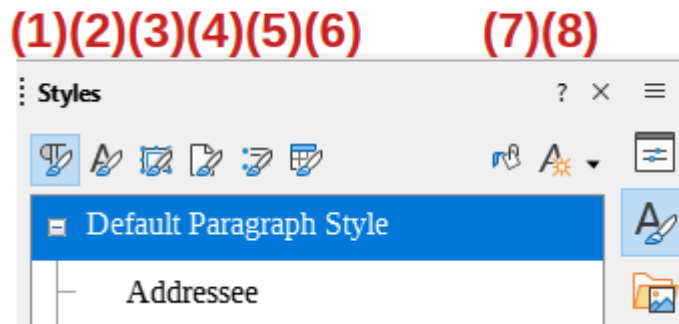

Figure 102: Styles categories and action buttons

- | | | |
|---------------|-----------|----------------------|
| (1) Paragraph | (4) Page | (7) Fill Format Mode |
| (2) Character | (5) List | (8) Styles Actions |
| (3) Frame | (6) Table | |

Note

The New Style from Selection dialog displays a list of custom styles that are available in the document. By default, a new style created from a selection is placed in the Custom Styles.

Dragging and dropping

In Writer and Calc, users can create a style by dragging and dropping a selected element into the Styles deck on the Sidebar. The new style is based on the formatting of the selected text or the selected cell. To use this method, perform the following steps:

- 1) Open the Styles deck on the Sidebar.
- 2) Open the list of styles in the style category by clicking on the icon for the required style category at the top of the Styles deck.
- 3) Select text or a cell in the open document, then drag and drop that element onto the Styles deck on the Sidebar.
- 4) Open the New Style from Selection dialog and enter a name for the new style in **Enter new style name** text box.
- 5) Click **OK** to create the new style in the selected style category and close the dialog. The new style is based on the formatting of the selected element and it is placed in **Custom Styles**.

Editing styles

When LibreOffice is installed onto a computer, a default set of styles is included. It provides a starting point for creating documents with styles. These default styles cannot be deleted, but can be edited to match the formatting requirements for documents.

All user-created styles can be edited or deleted. For more information on creating styles, see “Creating new styles” above.

Styles can be edited using one of the following methods:

- Dragging and dropping a formatted element into the Styles deck in the Sidebar.
- Select a formatted element and edit its style.
- Use AutoUpdate to edit paragraph and frame styles only.
- Add styles from another document or template into a document.

Note

Any editing, or changes made to a style are effective only in the current document. To edit or change styles in more than one document, the template has to be changed, or styles loaded from another document.

Using a styles dialog

A style can be edited with the Styles dialog. For more information on editing styles in a module, refer to the appropriate LibreOffice user guide.

- 1) Open the Styles deck on the Sidebar.
- 2) Click on the icon for the required style category at the top of the Styles deck to open the list of styles available in the selected style category.
- 3) Right-click on a style and select **Edit Style** from the context menu to open a style dialog applicable for the selected style category. Figure 103 shows an example of the Paragraph Styles dialog.
- 4) Use the various options available on the dialog pages to edit the selected style. If available, changes to a style can be checked in the preview box on the dialog page.
- 5) When changes are complete, click on **OK** to save the changes and close the dialog.

Set Paragraph Style or Apply Style

A style can also be edited with **Set Paragraph Style** for Writer or **Apply Style** for Calc on the Formatting toolbar by performing the following steps:

- 1) Select a paragraph in Writer or a cell in Calc.
- 2) On the Formatting toolbar, open a drop-down list of styles by clicking on the chevron **v** or triangle **▼** next to **Set Paragraph Style** for Writer or **Apply Style** for Calc.

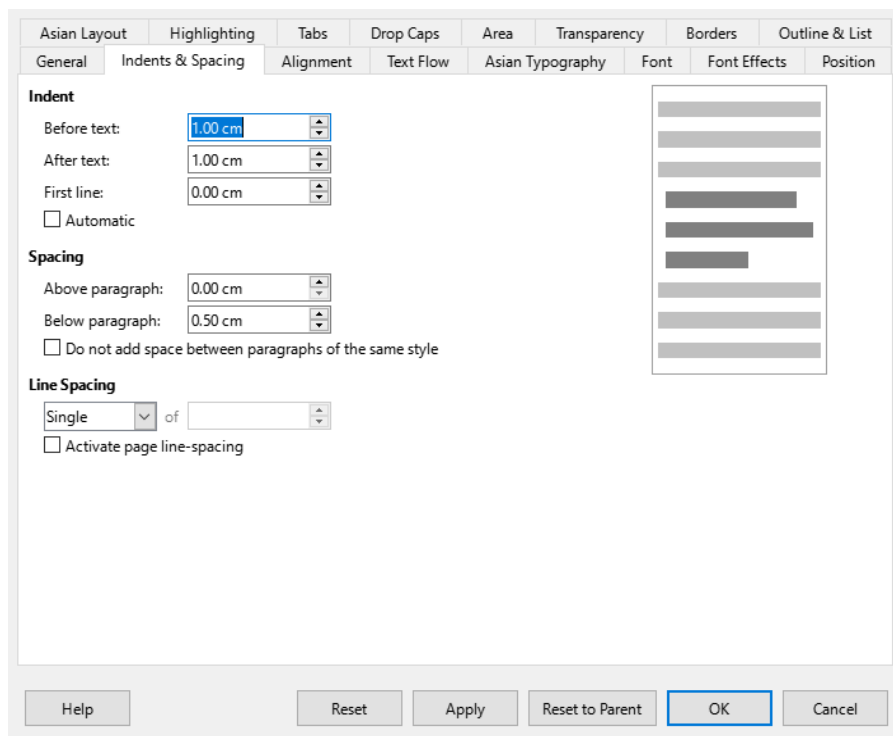

Figure 103: Paragraph Style dialog

- 3) Select a style and click on the chevron **v**, or triangle **▼** next to the style name, then select **Edit Style** from the context menu to open the Paragraph Style dialog (Figure 103).
- 4) Edit the selected style by using various options available on the dialog pages. Changes to a style can be checked in the preview box on the dialog page.
- 5) When changes have been completed, click on **OK** to save the changes and close the dialog.

Updating styles from selection

- 1) Open the Styles deck on the Sidebar.
- 2) Select the element that is formatted with the attributes of the desired style.
- 3) On the Styles deck, select the style that is going to be updated from the selection.
- 4) Update the style using one of the following methods:
 - At the top of the Sidebar, click on the chevron **v**, or triangle **▼** next to **Styles actions** and select **Update Selected Style** from the context menu.
 - In Writer or Calc, go **Styles > Update Selected Style** on the Menu bar.
 - Using **Set Paragraph Style** for Writer, or **Apply Style** for Calc, click on the chevron **v**, or triangle **▼** next to the selected style and select **Update to Match Selection** from the context menu.
 - Use the keyboard shortcut *Ctrl+Shift+F11* (macOS **⌘**+*Shift+F11*).

Using AutoUpdate

When the **AutoUpdate** option is selected on the **General** page of the Paragraph Style, or Frame Style dialog, a style is updated whenever you directly format a paragraph or frame that is in that style. In Writer, **AutoUpdate** only applies to paragraph and frame styles. See the *Writer Guide* for more information on **AutoUpdate**.

Renaming styles

In LibreOffice, only custom styles can be renamed.

- 1) Open the Styles deck on the Sidebar.
- 2) In the Styles drop-down list at the bottom of the Sidebar, select **Custom Styles** so you can see any custom styles that are available in the document.
- 3) Select the style that is going to be renamed from the displayed list of custom styles.
- 4) Right-click on the selected style and select **Edit Style** from the context menu to open the style dialog for the selected type of style.



Note

If **Modify** is grayed out in the context menu, then the selected style cannot be renamed.

- 5) Click on **General** to open the **General** page in the style dialog.
- 6) In the *Name* text box, enter a new name for the selected style.
- 7) Click on **Apply** to rename the selected style, then click **OK** to close the style dialog.

Deleting styles

Only custom styles can be deleted.

- 1) If not already open, open the Styles deck on the Sidebar.
- 2) In the styles category drop-down list at the bottom of the Sidebar, select **Custom Styles** to display any custom styles that are available in the document.
- 3) Select the style that is going to be deleted from the displayed list of custom styles. To delete multiple styles, hold down the *Ctrl* key (macOS ) while selecting styles.
- 4) Right-click on the selected style and select **Delete** from the context menu.
- 5) Click on **Apply** to delete the selected style, then click **OK** to close the style dialog.



Note

If **Delete** is grayed out in the context menu, then the selected style cannot be deleted.

If a style is deleted that is in use, all elements that used the deleted style will return to the default style.

Page styles

Page styles can be created in Writer or Calc. For more information on page styles, see the *Writer Guide* and the *Calc Guide*. For example, you can create a style that is only applied to the first page.

To create a new page style in Writer, do the following:

- 1) Open a new text document and open the Styles deck on the Sidebar.
- 2) Open the **Page Styles** panel and select **Page Styles** at the top of the Styles deck.
- 3) Click on **Styles actions** at the top of the Styles deck and select **New Style from Selection** from the context menu to open the New Style from Selection dialog.
- 4) Add the name of the new page style in the **Enter new style name** text box and click **OK**. This closes the New style from Selection dialog and the new page style appears in the **Page Styles** panel.
- 5) Right-click on the new page style in the **Page Styles** panel and select **Edit Style** from the context menu to open the Page Style dialog.
- 6) Modify and format the page with the options available on the Page Style dialog.
- 7) Click **OK** to save the changes and close the Page Style dialog.
- 8) To apply the new page style, double-click on the required page style.

Templates

A template is a document that contains user-specified formatting styles, graphics, tables, objects, and other information. LibreOffice can use a template to generate new documents with a common content and a common format. For example, you can add the outline of a report and also define paragraph and character styles in a document, save the document as a template, and then use the template to create a new document with the same report outline and styles.

All documents in LibreOffice are based on templates. The software has a number of predefined templates that can be used to create different types of documents, including business letters, presentations, or drawings. Templates can be created to suit your requirements. Also, templates

can be downloaded from the LibreOffice website using the following link:
<https://extensions.libreoffice.org>.

If a blank document is created in LibreOffice, then the software uses the appropriate LibreOffice default template. If required, this default template can be replaced by a custom template to suit user requirements, see “Setting default template” below for more information.

Custom LibreOffice templates

User-created templates are located in the My Templates folder and the next time LibreOffice is started, those templates appear in the LibreOffice startup window and the Select a Template dialog.

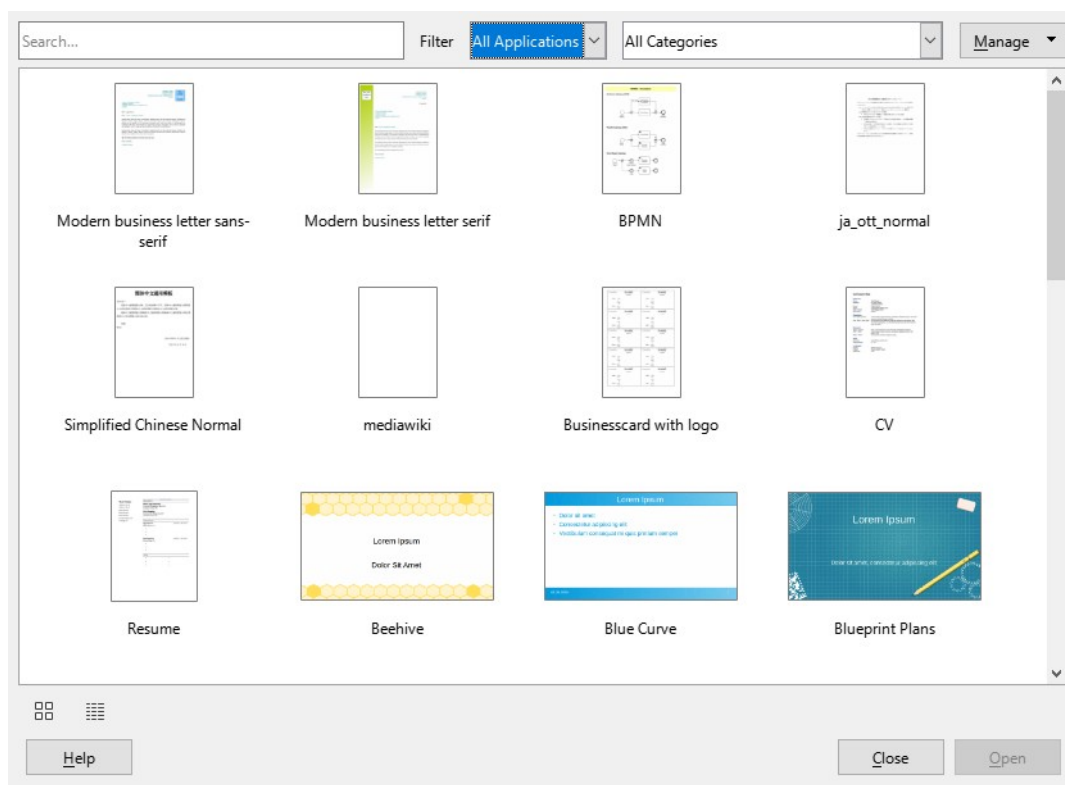

Figure 104: Templates dialog

Creating new documents from a template

A new document can be created in the Templates dialog by doing these steps:

- 1) Open the Templates dialog (Figure 104) by:
 - Select **File > New > Templates** on the Menu bar.
 - Select **File > Templates > Manage Templates** on the Menu bar.
 - Use the keyboard shortcut *Ctrl+Shift+N* (macOS *⌘+Shift+N*).
 - Click on the triangle ▼ next to **New** on the Standard toolbar and select **Templates** from the context menu.
 - Click on **Templates** in the LibreOffice Start Center.
- 2) Determine where to display the template and select the LibreOffice application and template category in the **Filter** drop-down lists.
- 3) Generate a document with the template with one of the following methods:

- Double-click on the selected template.
- Right-click on the template and select **Open** from the context menu.
- Click on **Open** on the Template dialog.

Creating a template

Any formatting element in a document can be saved in a template: for example, printer settings; file paths; text or object colors; and so on. Also, predefined text and graphics can be added to a template.

- 1) Open an existing document, or create a new document of the type required for a template.
- 2) Add any content that is required for the new template; for example company logo, copyright statement, and so on.

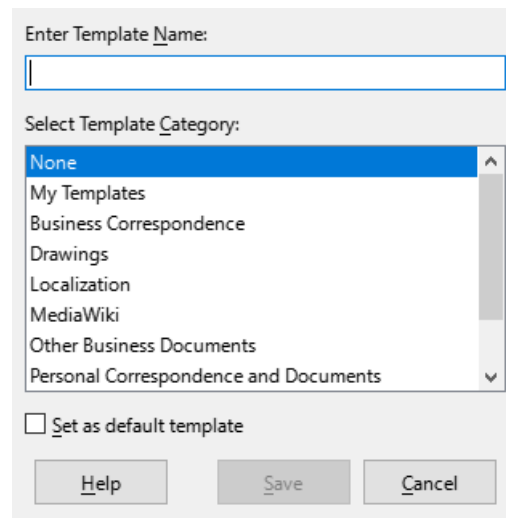

Figure 105: Save As Template dialog

- 3) Format any content added to the template requirements.
- 4) Create, or modify, any styles required for the new template.
- 5) Go to **File > Templates > Save as Template** on the Menu bar to open the Save As Template dialog (Figure 105).
- 6) Enter a name for the new template in the **Enter Template Name** text box.
- 7) Select a template category, from the categories available in **Select Template Category**.
- 8) If necessary, select **Set as default template** to change the default template for the required document type.
- 9) Click on **Save** to save template and close the Save As Template the dialog.

Template wizard

Writer has a Template Wizard which speeds up the template creation process. For more information on the Template Wizard, see the *Writer Guide*.

- 1) Go to **File > Wizards** on the Menu bar and select **Letter**, **Fax**, or **Agenda** to start a template for one of those types of documents. The Letter Wizard dialog is shown in Figure 106.
- 2) Go through the wizard and go through the steps as the wizard instructs.

- 3) Click on **Finish** and a Save as dialog opens.
- 4) Navigate to the required folder where the template is going to be saved.
- 5) Enter a file name in the text box using the file extension **OTT** for document templates.
- 6) Click on **Save** to save the new template and close the Save as dialog. The new template appears in the list of templates available.

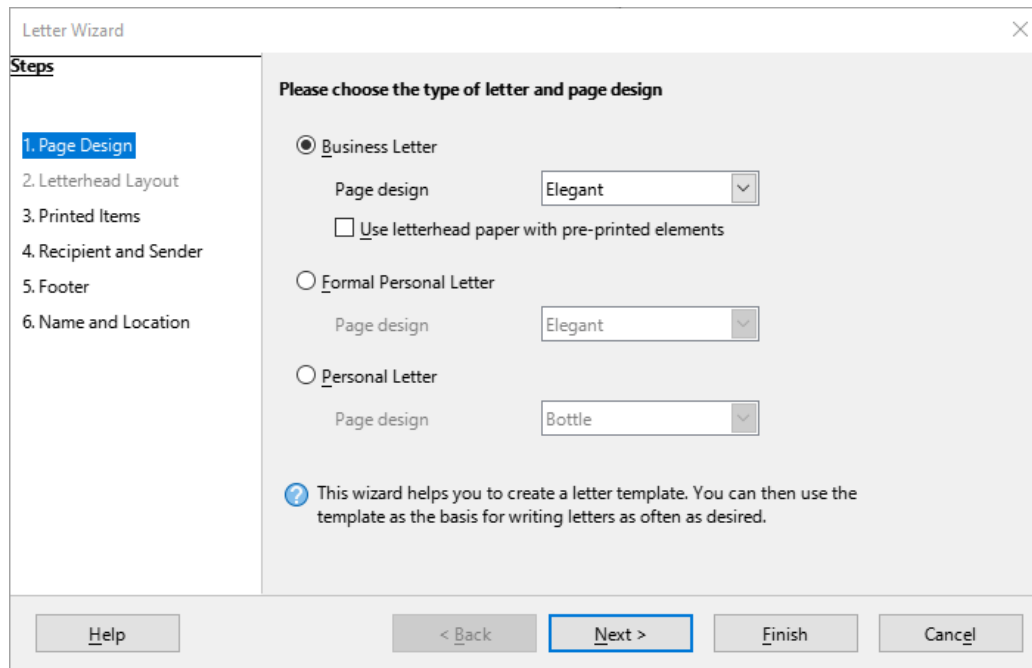

Figure 106: Letter Wizard dialog

Setting default template

LibreOffice allows you to specify a specific template as the default document. The template has to be in a location visible in the Save as Template dialog so that LibreOffice can find it, and you can always reset to the original LibreOffice default template if necessary.

Changing default template

- 1) Go to **File > New > Templates** or **File > Templates > Manage Templates** on the Menu bar to open the Templates dialog.
- 2) Select the document type from the *Filter* drop-down list.
- 3) Select the template to use as the default LibreOffice template for the selected document type.
- 4) Right-click on the selected template and select **Set as Default** from the context menu. A default template icon appears at the top right of the new default template.
- 5) Click on **Open** and a new document opens using the new default template. The next time a new document is created without selecting a different template, that document uses the new default template.

Resetting default template

- 1) Go to **File > New > Templates** or **File > Templates > Manage Templates** on the Menu bar to open the Templates dialog.
- 2) Select the presentation template that is being used as the default presentation template in the Select a Template dialog.

- 3) Right-click on the template and select **Reset Default** from the context menu.
- 4) Click on **Close** to close the Templates dialog. The next time that a new document is created and a specific template is not selected, the document is created using the original default LibreOffice template for that document type.

Editing templates

Default LibreOffice templates cannot be edited. Only templates that are created or imported can be edited.

- 1) Go to **File > New > Templates** or **File > Templates > Manage Templates** on the Menu bar to open the Templates dialog.
- 2) Right-click on the template to be edited and select **Edit** from the context menu and the template opens in the relevant LibreOffice module.
- 3) Edit and update the styles, text and/or objects on the selected template.
- 4) Go to **File > Save** on the Menu bar or use the keyboard shortcut *Ctrl*+*S* (macOS +*S*) to save the changes.
- 5) Close the template, or create a document, using the edited template.

Note

Any document created from a template before editing can be updated to show the changed template settings the next time the document is opened. A confirmation dialog opens asking if the updated styles are to be used or keep the old styles. If keep the old styles is selected, then the document continues to use the old styles without any confirmation.

Organizing templates

LibreOffice templates must be in specific LibreOffice template folders. New LibreOffice template categories can be created and used to organize LibreOffice templates. For example, separate template categories for different projects or clients. Templates can also be imported and exported.

Tip

The location of folders used LibreOffice template categories varies with computer operating systems. To learn where the template folders are stored on a computer, go to **Tools > Options > LibreOffice > Paths** (macOS **LibreOffice > Preferences > LibreOffice > Paths**).

Creating custom categories

- 1) Go to **File > New > Templates** or **File > Templates > Manage Templates** on the Menu bar to open the Templates dialog.
- 2) Click on **Manage** at the top right of the Templates dialog and select **New Category** from the context menu.
- 3) Enter a category name in *Enter new category name* box in the New Category dialog (Figure 107).
- 4) Click **OK** to save the new category and the category appears in the *Filter* drop-down list for categories at the top of the Templates dialog.

Deleting custom categories

- 1) Go to **File > New > Templates** or **File > Templates > Manage Templates** on the Menu bar to open the Templates dialog.
- 2) Select the custom category for deletion from the drop-down list of categories at the top of the Templates dialog.
- 3) Click on **Manage** at the top right of the Template dialog and select **Delete Category** from the context menu.
- 4) Click **Yes** to confirm the deletion of the custom category.

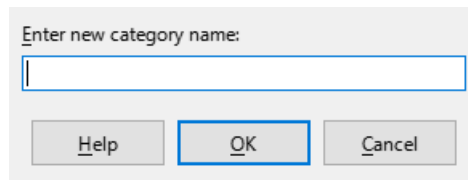

Figure 107: New Category dialog

Note

LibreOffice's default template categories or categories using the Extension Manager cannot be deleted. Only custom categories that have been created in Impress can be deleted.

Moving templates

- 1) Go to **File > New > Templates** or **File > Templates > Manage Templates** on the Menu bar to open the Templates dialog.
- 2) Right-click on the template that is going to be moved and select **Move** from the context menu.
- 3) In the Select Category dialog (Figure 108), select a category from the displayed list of categories, or enter a name in the **Create a New Category** box to create a new category for the template.
- 4) Click **OK** to move the template to its new category and close the Select Category dialog.

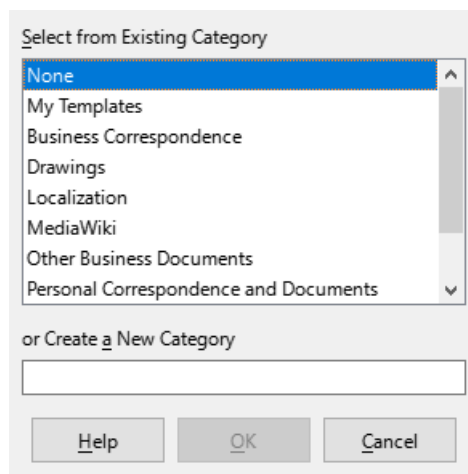

Figure 108: Select Category dialog

 **Note**

Only custom templates can be moved between categories. Templates supplied with LibreOffice or installed with the Extension Manager cannot be moved.

Deleting templates

- 1) Go to **File > New > Templates** or **File > Templates > Manage Templates** on the Menu bar to open the Templates dialog.
- 2) Right-click on the template being deleted and select **Delete** from the context menu.
- 3) Click on **Yes** to confirm the deletion.

 **Note**

Templates supplied with LibreOffice, or installed using the Extension Manager, cannot be deleted. Only templates that have been created in LibreOffice, or imported from other sources, can be deleted.

Renaming templates

- 1) Go to **File > New > Templates** or **File > Templates > Manage Templates** on the Menu bar to open the Templates dialog.
- 2) Right-click on the template being renamed and select **Rename** from the context menu.
- 3) Enter a new template name in the text box that has opened, then click on **OK** to save the new template name.

 **Note**

Templates supplied with LibreOffice or installed with the Extension Manager, cannot be renamed. Only templates that have been created in LibreOffice or imported from other sources can be renamed.

Importing templates

LibreOffice uses the term “repositories” when it refers to sources for templates. A repository can be a directory on a computer or a location on the internet. The community-created template repository for LibreOffice is at <https://extensions.libreoffice.org/>.

If a template is in a different location on the computer, then the template must be imported into a LibreOffice category for LibreOffice to recognize the template.

- 1) To import a template onto the computer, go to <https://extensions.libreoffice.org/> or another internet location and download the required template to your computer.
- 2) Open the Templates dialog by selecting **File > New > Templates** or **File > Templates > Manage Templates** on the Menu bar.
- 3) Find the **Filter** drop-down lists then select the required document type and template category.
- 4) Click on **Manage** at the top right of the Template dialog and open the Open dialog by selecting **Import** from the context menu.
- 5) Use the Open dialog, to find the folder where the template is located on the computer.
- 6) Display the available templates by selecting the **Templates** in the *File type* box.
- 7) Select the template and click **Open to** import template into the selected category.

Exporting templates

- 1) Open the Templates dialog by selecting **File > New > Templates** or **File > Templates > Manage Templates** on the Menu bar.
- 2) Activate the context menu by right-clicking on the template to be exported then select **Export** from the menu. A file browser window will appear.
- 3) Navigate to the folder where the template will be exported and click on **OK**. The template is exported to the selected location and the browser closes.

Hyperlinks

In LibreOffice, hyperlinks allow you to create references to web pages and other elements in remote locations.

Absolute and relative hyperlinks

There are two types of hyperlinks: absolute and relative.

- An absolute hyperlink links to a web page, or file, that is outside the current domain or file location. It must contain the full address of the target file, or web site, such as <https://libreoffice.org>. An absolute hyperlink will stop working if its target is moved to a new location in the internet.
- A relative hyperlink contains an address that is relative to the document's current file location. A relative hyperlink stops working if the document is removed from the current location.

Inserting hyperlinks

- 1) Select the location where the hyperlink will be inserted.
- 2) Go to **Insert > Hyperlinks** on the Menu bar or use the keyboard shortcut *Ctrl+K* (macOS +K) to open the Hyperlink dialog (Figure 109).
- 3) On the left hand side, determine whether the hyperlink will be absolute or relative.
- 4) Click **Apply** to insert the hyperlink into the document.
- 5) Click **Close** or **OK** to close the dialog.



Tips

LibreOffice automatically converts website URLs into hyperlinks. To turn off this function, go to **Tools > AutoCorrect Options > Options** and deselect **URL Recognition**.

To change the color of hyperlinks, go to **Tools > Options > LibreOffice > Application Colors** (macOS **LibreOffice > Preferences > LibreOffice > Application Colors**), and scroll to the *Unvisited links* and/or *Visited links* checkboxes. Select them, choose new colors from the color palettes for the links, and click **OK**. Note that this color change changes the color for all hyperlinks across all LibreOffice modules.



Note

In Writer and Calc, the Navigator can be used to insert hyperlinks. For information, see the *Writer Guide* and *Calc Guide*.

Hyperlink types

To choose a hyperlink type, go to **Insert > Hyperlinks** on the Menu bar or use the keyboard shortcut *Ctrl+K* (macOS $\text{⌘}+K$) to open the Hyperlink dialog.

Internet

Enter the required web address in the *URL* text box and a name for the hyperlink in the *Text* text box (Figure 109).

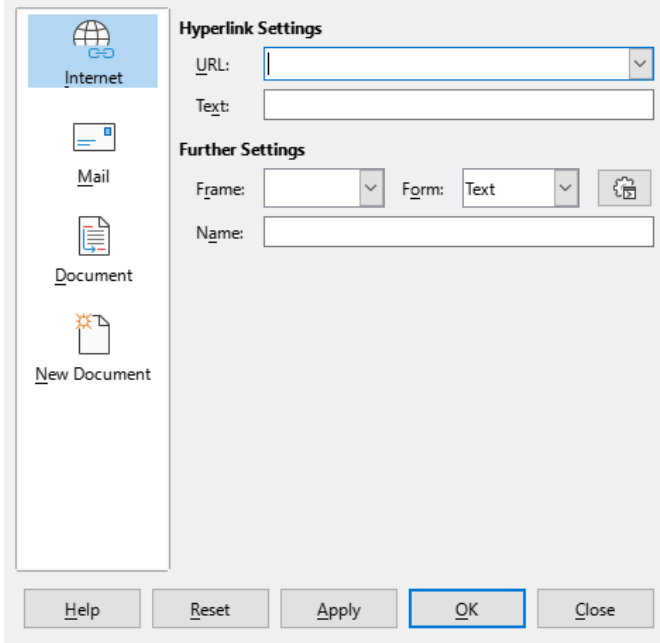

The screenshot shows the Hyperlink dialog box with the 'Internet' page type selected. The 'Hyperlink Settings' section includes a 'URL' dropdown menu and a 'Text' text box. The 'Further Settings' section includes a 'Frame' dropdown menu, a 'Form' dropdown menu set to 'Text', and a 'Name' text box. At the bottom, there are buttons for 'Help', 'Reset', 'Apply', 'OK', and 'Close'.

Figure 109: Hyperlink dialog — Internet page

Mail

Go to **Insert > Hyperlinks** on the Menu bar or use the keyboard shortcut *Ctrl+K* (macOS $\text{⌘}+K$) to open the Hyperlink dialog. Enter email details in *Recipient* and the subject of the link in *Subject* (Figure 110).

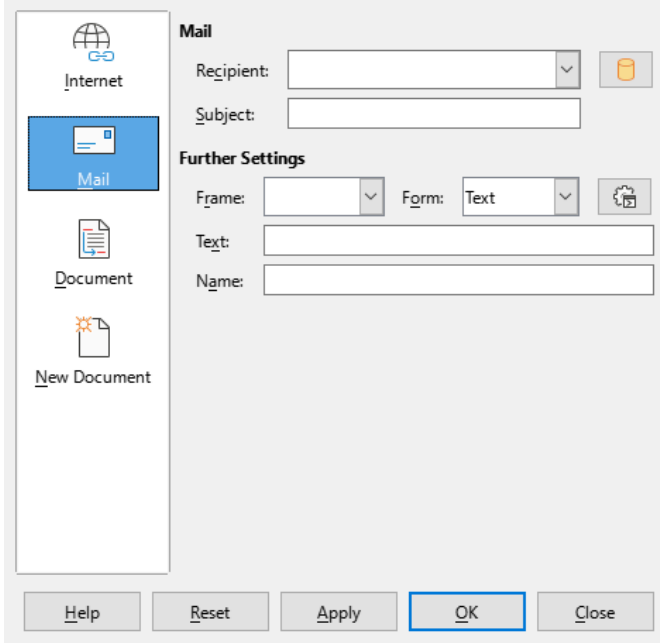

The screenshot shows the Hyperlink dialog box with the 'Mail' page type selected. The 'Mail' section includes a 'Recipient' dropdown menu and a 'Subject' text box. The 'Further Settings' section includes a 'Frame' dropdown menu, a 'Form' dropdown menu set to 'Text', and a 'Text' text box. At the bottom, there are buttons for 'Help', 'Reset', 'Apply', 'OK', and 'Close'.

Figure 110: Hyperlink dialog — Mail page

Document

Links to another document or to another place in a document, commonly referred to as a bookmark. Enter the details in the *Path* text box, or click on **Open File** to open a file browser. Leave this blank if the link is to a target in the same document (Figure 111).

Optionally, specify a target, for example, a specific slide in a presentation. Click on **Target in Document** to open a dialog where a target can be selected. If the name of the target is known, type it into the *Target* text box.

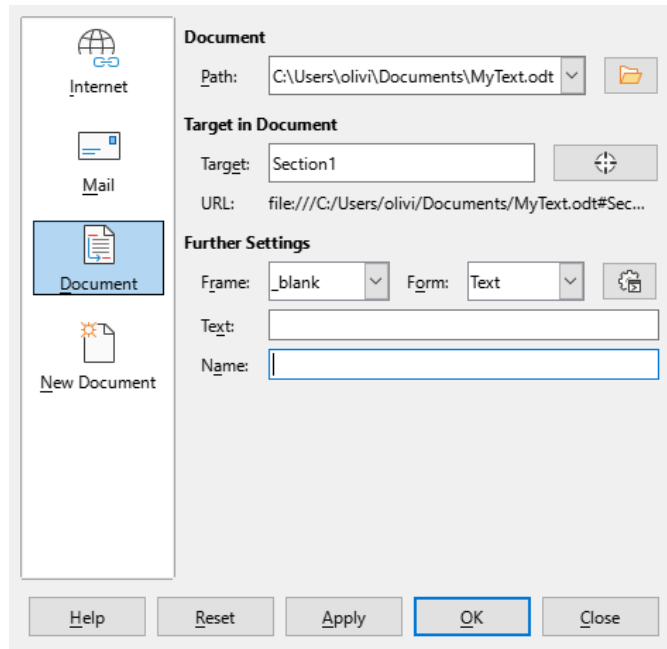

Figure 111: Hyperlink dialog — Document page

New Document

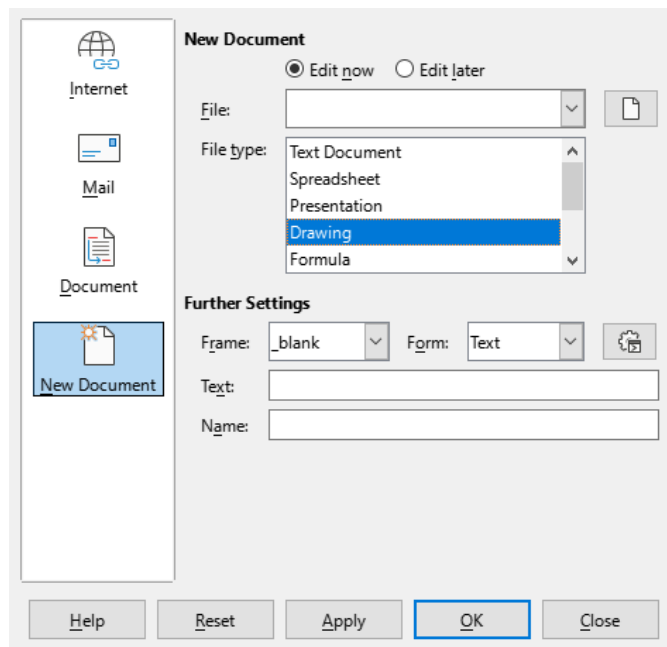

Figure 112: Hyperlink dialog — New Document page

Links a new document. Select **Edit now** to edit the newly created document immediately or **Edit later** to only create the hyperlink. Choose the type of document to create from the

File type drop-down list. Click on **Select path** to open a file browser so that a directory is selected for the new document (Figure 112).

Further Settings

These settings are common to all hyperlink types, though some choices are more relevant to some types of links.

Frame

Set the value to determine how the hyperlink opens. This applies to documents that open in a web browser.

Form

Specifies if the link is to be presented as text or as a button.

Text

Specifies the text that will be visible to the user.

Name

Applicable to HTML documents. It specifies text that will be added as a NAME attribute in the HTML code behind the hyperlink.

Editing hyperlinks

- 1) Select a hyperlink using one of the following methods (depends on the module):
 - Click anywhere in the hyperlink text.
 - Click and drag a selection marquee over the hyperlink text to display a text box border and selection handles.
 - Double-click on a hyperlink to open an editing box.
- 2) Select editing mode and open the Hyperlink dialog using one of the following methods:
 - Click on **Insert Hyperlink** on the Standard toolbar.
 - Go to **Edit > Hyperlink** on the Menu bar.
 - Use the keyboard shortcut *Ctrl*+*K* (macOS +*K*).
 - Right-click and select **Edit Hyperlink** from the context menu.
- 3) Modify the link in the Hyperlink dialog then click **Apply** to save the changes. The Hyperlink dialog remains open.
- 4) Once you have finished editing hyperlinks, click on **OK** to close the Hyperlink dialog.

Removing hyperlinks

To turn a hyperlink into plain text, right-click on the link and select **Remove Hyperlink** from the context menu. To delete a hyperlink, select the hyperlink and press the *Delete* or *Backspace* key.



LibreOffice
Community



Chapter 5, Working with Images and Graphics

Images, Graphics, Gallery, Drawing Tools, Fontwork

Introduction

Adding image and graphic files to LibreOffice documents consist of the following types:

- Image and graphic files, for example photos, drawings, PDF documents, and scanned images.
- Diagrams created using LibreOffice Draw.
- Artwork created using clipart or Fontwork.
- Charts created using LibreOffice Calc.
- Images, clipart and diagrams from the LibreOffice Gallery.

This chapter provides basic instructions and information for image and graphic files. For more detailed information and instructions on image and graphic files, see the specific user guide available for each LibreOffice module.

Images and graphics

Creating

Image and graphic files are created using a graphics program, scanning, or downloading from the Internet, or photos from a digital camera. When downloading image and graphic files from the Internet, make sure the licensing, or copyright, allows the use of an image or graphic.

LibreOffice can import, rotate and flip various vector (line drawing) image and graphic files. LibreOffice also supports raster (bitmap) file formats and the most common formats for raster files are GIF, JPG, PNG, and BMP. See Appendix B for a full list of image and graphic formats that LibreOffice can import.

LibreOffice can also import SmartArt images from Microsoft Office files. For example, Writer can open a Microsoft Word file that contains SmartArt and edit the SmartArt images.

Editing

To edit photos and other bitmap images, use a bitmap editor. To edit line drawings, use a vector drawing program. There is no need to use additional graphic applications because LibreOffice Draw has the capability to edit images and graphics.

Freely available Open-source tools are also a good alternative when editing image and graphic files, for example GIMP (bitmap editor) and Inkscape (vector drawing program). Open-source tools and many other Open-source applications work on Windows, macOS, and Linux operating systems.

Adding

Image and graphic files can be added to a document using one of the following methods:

- Inserting a file directly from a graphics program, or a scanner.
- Dragging images and graphics from a clipart gallery.
- Copying and pasting from a source on a computer.

Inserting

When an image, or graphic, file is available on the computer being used, the file is inserted into a LibreOffice document using one of the following methods. These insertion methods are only examples because actual insertion does depend on the following:

- Computer operating system.
- Computer setup.
- LibreOffice module being used.

Drag and drop

Dragging and dropping embeds a copy of the file into a document.

- 1) Open a file browser window and locate the file to be inserted.
- 2) Drag the file into the LibreOffice document and drop it on the selected page.

Note

To link an image, or graphic, file instead of embedding, hold down the *Ctrl+Shift* keys (macOS *⌘+Shift*) while dragging the file.

Insert Image dialog

- 1) Open a LibreOffice document and click on the page where the image, or graphic, is to be inserted.
- 2) Go to **Insert > Image** on the Menu bar to open the Insert Image dialog (Figure 113). This dialog is similar to a file browser window.

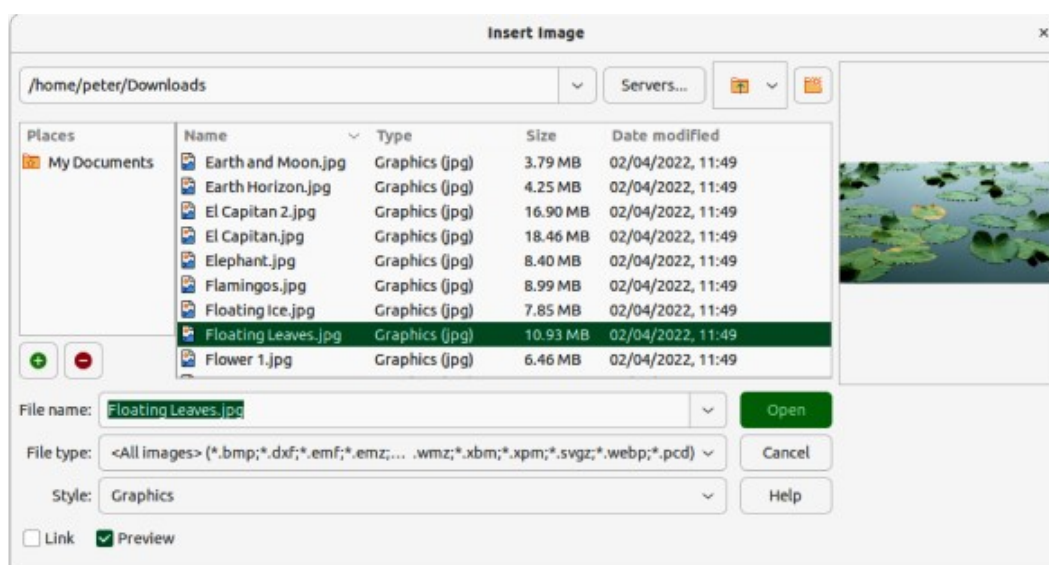

Figure 113: Insert Image dialog

- 3) Navigate to where the file is located and select it. If the **Preview** option is selected in the Insert Image dialog, a preview of the selected image, or graphic, appears in the **Preview** box.
- 4) Click on **Open** and the image, or graphic, is embedded into the document and Insert Image dialog closes.
- 5) If the image, or graphic, is going to be linked and not embedded, select the **Link** option before clicking **Open**.

Note

If the Link option is selected, a message box appears when **Open** is clicked and the Confirm Linked Graphic dialog opens. Select **Keep Link** to the link the file, or **Embed Graphic** to embed the image, or graphic. To prevent this message from appearing again, deselect the option **Ask when linking a graphic**. When inserting the same image, or graphic, several times in a document, LibreOffice embeds only one copy of the file.

Copy and paste

- 1) Open both the source and target documents.
- 2) In the source document, select the image to be copied and copy the image to the clipboard. Keyboard shortcut *Ctrl+C* or *Ctrl+Ins* (macOS *⌘+C*)
- 3) In the target document, click at the position where the image is to be placed.
- 4) Paste the image from the clipboard into the document. Keyboard shortcut *Ctrl+V* or *Shift+Ins* (macOS *⌘+V*)

Note

Embedding

If the source document is closed before the image is pasted into the target document, the image stored on the clipboard could be lost.

Embedding linked image, or graphic, files breaks the link to the file and becomes part of the document. Linked images, or graphics can be embedded as follows:

- 1) Open a document in LibreOffice and go to **Edit > External Links** on the Menu bar to open the Edit Links dialog (Figure 114).

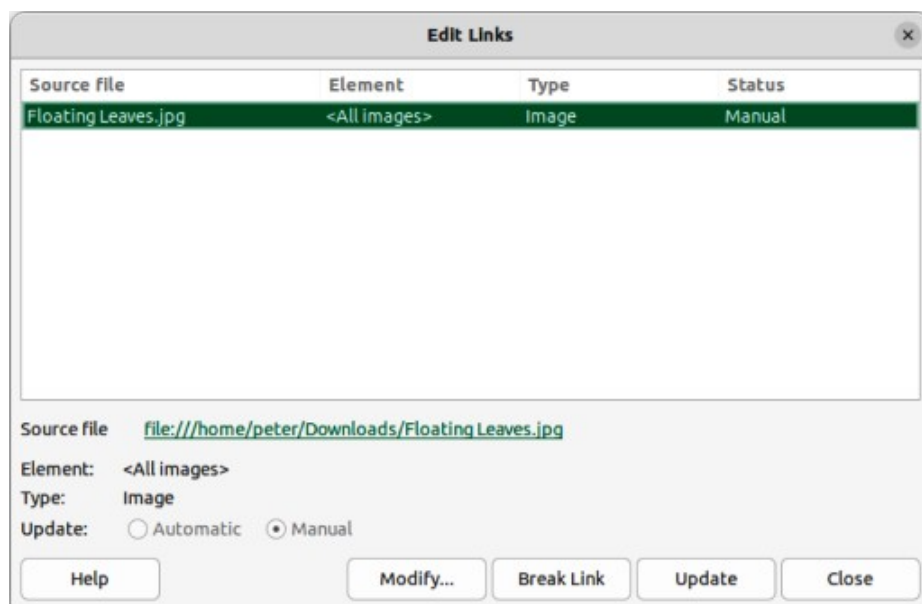

Figure 114: Edit Links dialog

- 2) Select the files that are going to be embedded.
- 3) Click on **Break Link**, then click **Yes** to confirm embedding the files.

Linking

When linking images, or graphics, LibreOffice creates a link to the file instead of saving a copy of the file in a document. The result is that the image, or graphic, is displayed in the document. However, when the document is saved, it contains only a reference to the linked file, not the file itself. The document and the image, or graphic, remain as two separate files reducing file size.

Advantage

File can be modified separately using a graphics program. The modified image, or graphic, appears the next time the document is opened. This is an advantage if another person is updating the files, for example a graphic artist.

Advantage

Linking reduces the file size of the document when it is saved, because the file itself is not included in the document. However, file size is usually not a problem on modern computers, and LibreOffice can handle large files.

Disadvantage

Sending a document with linked files to another computer, the linked files must also be sent, or moved with the document so that the receiver sees the linked images, or graphics in the document. Keep track of the file locations and make sure any recipient knows where to store the files so the document can find the files when it is opened. For example, image files placed in a subfolder named Images in the folder containing the document. The recipient needs to put the image files in an Images subfolder in the same folder the document has been placed.

Scanning

If a scanner is connected to a computer, LibreOffice can use the scanning software to scan an image, graphic, or document, then place the scanned media into the open document. The following scanning procedure is an example of how to insert scanned media into a document.

- 1) Go to **Insert > Media > Scan > Select Source** on the Menu bar and select the scanning source from the list of available devices.
- 2) Click in the document where the scanned media is to be inserted.
- 3) Place the media for scanning onto the selected scanner.
- 4) Go to **Insert > Media > Scan > Request** on the Menu bar to open the scanning software.
- 5) Click on **Preview** in the scanning software to scan the media and a preview image appears in the scanning software.
- 6) Adjust settings for image quality, size, and other attributes in the scanning software.
- 7) Click on **Scan** in the scanning software and the media is scanned. A scanned copy of the media is inserted into the LibreOffice document.
- 8) Click on **Close** in the scanning software to close the scanning application.



Note

The scanning software must be an application that LibreOffice recognizes and is compatible to scan and insert media into a document.

After a scanning sources has been selected, LibreOffice remembers the selected scanning source. This eliminates the need to select a scanning source each time scanned media is inserted into a document.

Inserting using the Gallery

The Gallery (Figure 115) provides a convenient way to insert media, such as graphics and sounds, into documents. The Gallery is available in the Writer, Calc, Impress, and Draw modules of LibreOffice. When copied, Gallery images are embedded into a document, but can also be linked to the Gallery image. See “LibreOffice Gallery” below for more information.

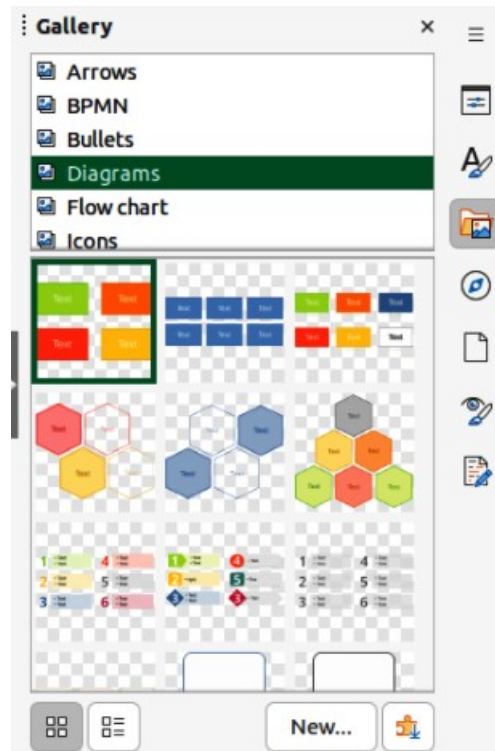

Figure 115: Gallery deck in Sidebar — Icon View

- 1) Click on **Gallery** on the right side of the Sidebar, or use the keyboard shortcut *Ctrl+Alt+3* (macOS *⌘+⌥+3*) to open the Gallery deck.
- 2) Select a Gallery theme from the list provided.
- 3) Select the required image from the displayed images with a single click.
- 4) To insert the required image into the document use one of the following methods:
 - Drag and drop the image into the document.
 - Right-click on the image and select **Insert** in the context menu. This places the image in the center of the document.
- 5) To insert an image as a link, hold down the *Shift* and *Ctrl* (macOS *⌘*) keys, then drag and drop the object into the document.

Editing images or graphics

LibreOffice provides many tools for editing images and graphics. These tools are described in more detail in the relevant user guide for each LibreOffice module. Editing images, or graphics, consists of the following:

- Cropping, resizing, modifying, filtering, and positioning.
- Wrapping text around images.
- Using images as backgrounds and watermarks.

For complex editing, it is recommended to use a graphics application, such as Gimp, or Inkscape. The edited image, or graphic, can then be inserted into LibreOffice.

Image toolbar

When an image is inserted, or an image is selected in the document, the Image toolbar opens automatically. If the Image toolbar does not open, go to **View > Toolbars** on the Menu bar and select Image from the submenu. Two other toolbars also become available when an image is selected:

- Image Filter toolbar, which can be used as a floating toolbar.
- Color toolbar, which opens as a separate floating toolbar.

Using these three toolbars together, corrections and adjustments can be applied to an image. Also, special effects can be applied, such as transparency, color adjustment, flipping and rotation, and special effect filters.

Cropping

If only a part of an image, or graphic, is to be used in a document, it can be cropped. LibreOffice provides two ways to crop an image, or graphic:

- **Crop** tool — available as a tool on toolbars, or in a context menu after right-clicking on an image, or graphic. The **Crop** tool provides a quick and easy way to crop an image, or graphic.
- **Crop** page in the Writer Image dialog — accessed by right-clicking on the image, or graphic, and selecting **Properties** in the context menu. The **Crop** page provides more control when cropping.

Note

When an image, or graphic, is inserted into a LibreOffice document and is cropped, the image, or graphic, itself is not cropped. LibreOffice masks the parts of the image, or graphic, that have been cropped. If the document is exported as HTML, the original image, or graphic, is also exported. For exporting individual cropped images, or graphics, see “Exporting” on page 205.

Resizing

To fit an image, or graphic, into a LibreOffice document, it may have to be resized. The quickest way to resize an image, or graphic, is to use the selection handles as shown by the following example.

- 1) Click on an image, or graphic, to display the selection handles.
- 2) Position the cursor over one of the selection handles and the cursor changes shape, giving a graphical representation of the resizing direction as follows:
 - Corner handles simultaneously resizes both width and height of an image.
 - Horizontal handles resizes the height of an image.
 - Vertical handles resizes the width of an image.
- 3) Click on a selection handle and drag to resize the image, or graphic. During resizing, a ghost image appears helping to resize an image, or graphic, (Figure 116).
- 4) To maintain the original height and width proportions of an image while dragging using a selection handle, hold down the *Shift* key before dragging a selection handle. Remember to release the *Shift* key before releasing the selection handle.

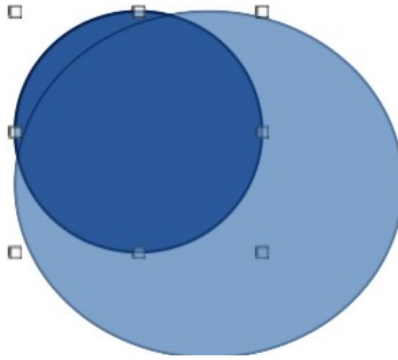

Figure 116: Example of resizing an image

Positioning

After inserting an image, or graphic, into a LibreOffice document, it may have to be repositioned to achieve the correct document format. The quickest way to resize an image, or graphic, is to use the cursor as shown by the following example.

- 1) Select an image, or graphic, to display the selection handles.
- 2) Move the cursor over a selected image, or graphic, and the cursor changes shape to a grabbing cursor. The grabbing shape depends on the computer setup and the computer operating system.
- 3) Click and drag the selected image, or graphic, to the desired position. During movement, a ghost image appears helping with repositioning (Figure 117).
- 4) Release the cursor when the image, or graphic, is in the desired position.

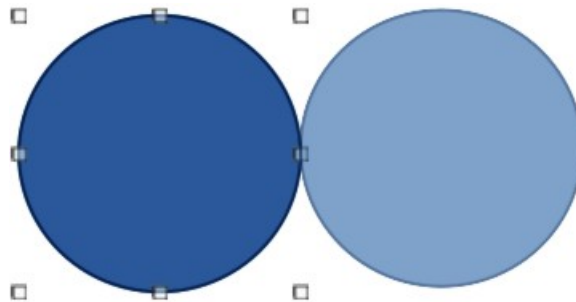

Figure 117: Example of positioning an image

Tip

The arrow keys on the keyboard can also be used to quickly move a selected image, or graphic, into a new position.

Rotating images

After inserting an image, or graphic, into a LibreOffice document, it can be rotated to achieve the correct document format. The quickest way to rotate an image, or graphic, is to use the cursor as shown by the following example.

- 1) Click on an image, or graphic, to display the selection handles.
- 2) Click again (NOT double-click) on the selected image, or graphic, switching on rotation mode, or go to **Format > Rotate** on the Menu bar.

Note

Using a double-click on an image, or graphic, switches on text editing mode for the selected image, or graphic.

- 3) Move the cursor over one of the corner handles and the cursor changes shape indicating the movement direction.
- 4) Click on a corner selection handle and move in the direction required to rotate the object. Only the corner selection handles are active for rotation.
- 5) When satisfied with the rotation, release the cursor.
- 6) To restrict the rotation angles to multiples of 15 degrees, press and hold the *Shift* key while rotating the image. This is useful for rotating images through a right angle, for example from portrait to landscape. Remember to release the *Shift* key before releasing the cursor.
- 7) To change the rotation center of the object, click and drag the central pivot point to the desired position before rotating. The central pivot point can be moved to any position on the document, even outside of the image boundaries.

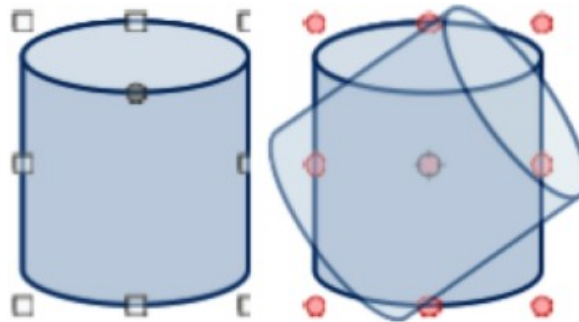

Figure 118: Example of rotating an image

Flipping

After inserting an image, or graphic, into a LibreOffice document, it can be flipped either vertically, or horizontally. Depending on which LibreOffice module is being used, use one of the following methods to quickly flip an image, or graphic:

- Right-click on the selected image, or graphic, and select **Flip > Vertically** or **Horizontally** from the context menu.
- Click on **Vertically**, or **Horizontally** on the Line and Filling toolbar.
- Click on **Flip Vertically**, or **Flip Horizontally** on the Image toolbar.
- Go to **Format > Flip > Vertically**, or **Horizontally** on the Menu bar.
- Go to **Format > Rotate or Flip > Flip Vertically**, or **Flip Horizontally** on the Menu bar
- Click on **Flip Vertically**, or **Flip Horizontally** in the **Position and Size** panel on the Properties deck of the Sidebar.

Arranging

LibreOffice organizes images and graphics in a stack. The image, or graphic, on the top level of a stack covers the images and graphics on the lower levels, if any overlapping occurs. Select images, or graphics, and use one of the following methods to change the stack level:

- Click on the required arrange tool on the Line and Filling toolbar.

- Right-click on selected objects and select **Arrange** from the context menu, then select the required arrange option from the sub-context menu.
- Go to **Format > Arrange** on the Menu bar and select an option from the submenu.
- Use the keyboard shortcut available for each arrangement option.

The stack level of each image, or graphic, can be changed. The options available for arranging the stack level of images, or graphics are as follows:

Bring to Front

Selected object is moved in front of all other objects. Keyboard shortcut *Ctrl+Shift++* (macOS +*Shift++*).

Bring Forward

Selected object is moved one level up in the stack. Keyboard shortcut *Ctrl++* (macOS ++).

Send Backward

Selected object is moved one level down in the stack. Keyboard shortcut *Ctrl+-* (macOS +-).

Send to Back

Selected object is moved behind all other objects. Keyboard shortcut *Ctrl+Shift+-* (macOS +*Shift+-*).

In Front of Object

Moves the first selected object in front of the second selected object. Select the first object, then click on the second object and the objects swap position.

Behind Object

Moves the first selected object behind the second selected object. Select the first object, then click on the second object and the objects swap position.

Reverse

Swaps the stacking order of two selected objects.

Alignment and positioning

When an image, or graphic, is added to a document, the alignment and positioning has to be selected in respect to text and other objects on a document page.

Arrangement

Is the positioning of an image, or graphic, on an imaginary vertical axis. Arrangement controls how images, or graphics are stacked upon each other, or relative to the text.

Alignment

is the vertical, or horizontal positioning of an image, or graphic, in relation to the selected anchor point.

Anchoring

Is a reference point for that an image, or graphic, is fixed in a document. This reference, or anchor point can be a page, frame, cell, paragraph, or character. An image, or graphic, always has an anchor point.

Text wrapping

In a document refers to the relation of images and graphics to the surrounding text. Options for text wrapping allow the text to wrap around an image, or graphic, as follows:

- One or both sides of the image, or graphic.

- Above or below of the image, or graphic.
- Allow text overprint of the image, or graphic.
- Allow of the image, or graphic, to cover the text.
- Treat the image, or graphic, as a separate paragraph, or character.

Exporting

To use another graphics application to edit an image, or graphic, the file is exported directly from the document. The following procedure is an example only. Actual procedure depends on the computer operating system and computer setup.

- 1) Right-click on the image, or graphic.
- 2) Select **Save** from the context menu to open the Image Export dialog (Figure 119).
- 3) Navigate to the folder where the image, or graphic, is going to be exported to.
- 4) Enter a file name in the **File name** text box and select the file type from the options available from the drop-down list in **File type**.
- 5) Click on **Save** to export the file and close the dialog.
- 6) Open the graphics program, then navigate to the folder where the file is located.
- 7) Carry out the necessary editing to the file and save the file in the required format. The image, or graphic, can then be re-inserted back into the document.

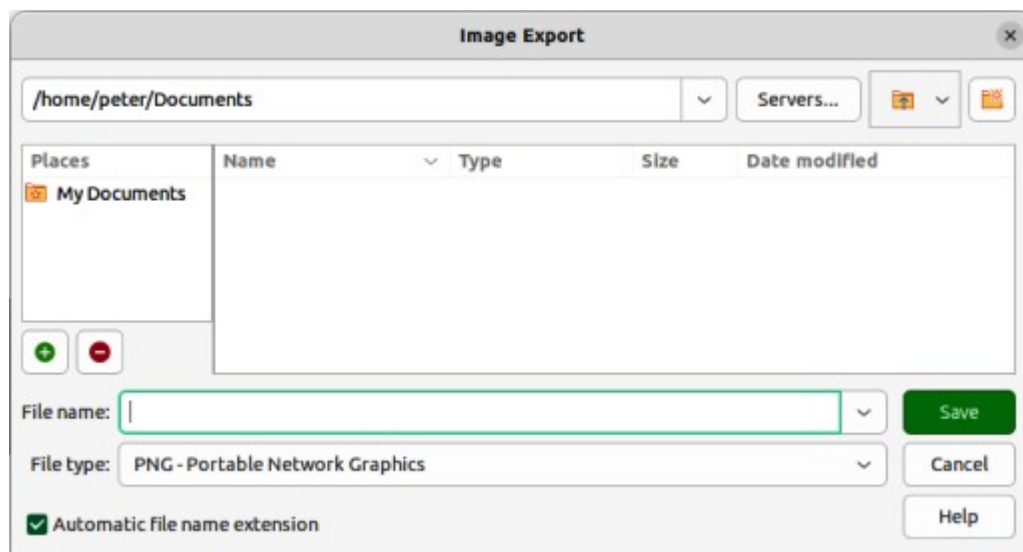

Figure 119: Image Export dialog

Compressing

If an image, or graphic, has a large file size, it can be compressed to reduce the file size. This results in a smaller file size for the document, but may result in a loss of quality when the image, or graphic, is compressed. The following procedure is an example only. Actual procedure depends on the computer operating system and computer setup.

- 1) Right-click on the image, or graphic.
- 2) Select **Compress** from the context menu to open the Compress Image dialog (Figure 120).
- 3) Use options available in **Compression** and **Resolution** to compress the image, or graphic.

- 4) If necessary, click on **Calculate New Size** and check the file size of the compressed image, or graphic.
- 5) Click on **OK** to save the changes and close the dialog.
- 6) If the resulting image is not acceptable, undo the changes and repeat the procedure using different compression settings.

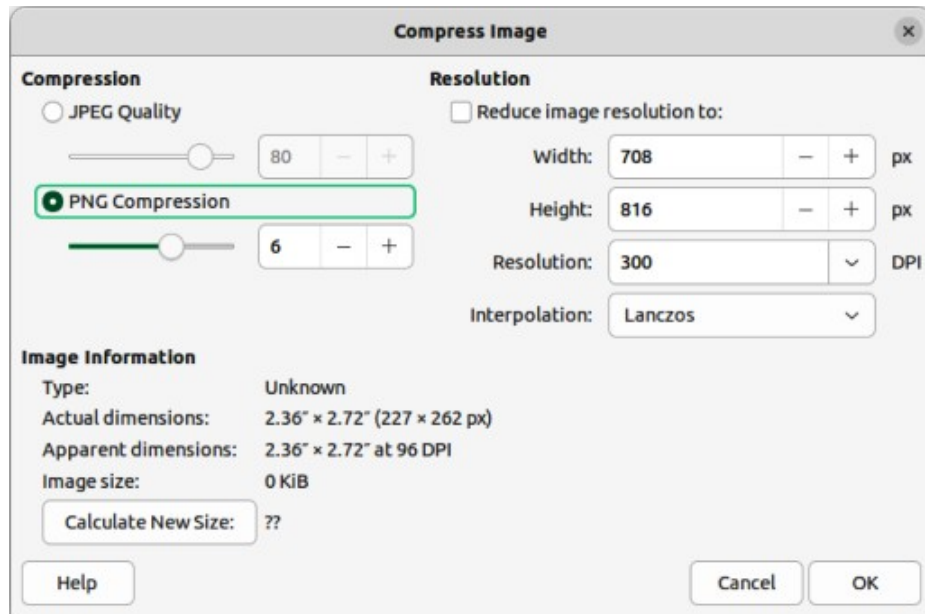

Figure 120: Compress Image dialog

LibreOffice Gallery

Graphics in the Gallery are grouped by themes, such as Arrows, Diagrams, and Icons, and are installed when LibreOffice is installed on a computer. The Gallery can be displayed in **Icon View** (Figure 115 on page 200), or **Detailed View** (Figure 121).

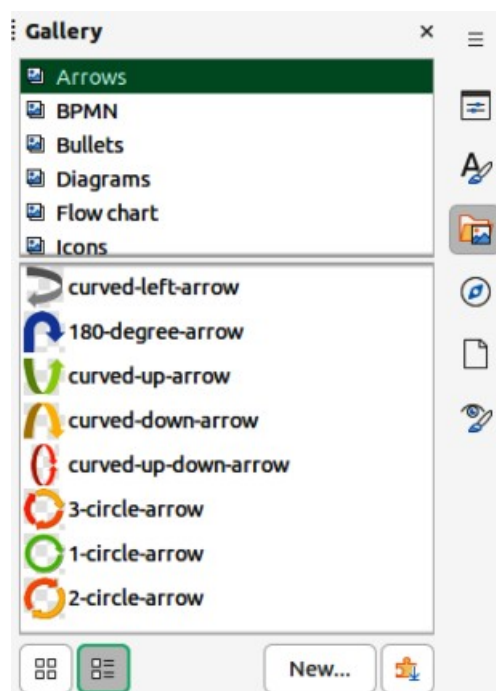

Figure 121: Gallery deck on Sidebar — Detailed View

Inserting Gallery images and graphics

The Gallery deck on the Sidebar contains a collection of images and graphics that can be used in a document. Images and graphics can also be added to the Gallery, making it an essential tool for inserting images and graphics into a document quickly. The Gallery is available for all LibreOffice modules.

- 1) Open the Gallery deck in the Sidebar using one of the following methods:
 - Go to **Insert > Media > Gallery** on the Menu bar.
 - Click on **Gallery** in the Sidebar.
- 2) Select a theme from the available themes and the images and graphics for that theme are displayed.
- 3) Scroll through the available images and graphics and select the required image or graphic.
- 4) Click and hold on the image or graphic and drag it onto the slide. Release the hold and the image or graphic is inserted centrally onto the page.
- 5) Format the image or graphic to the document requirements.

Default themes

Images and graphics in the Gallery are grouped by themes, such as Arrows, Bullets, Diagrams and so on. These default themes are listed alphabetically in the box at the top of the Gallery deck on the Sidebar. Click on a theme name to see its images and graphics displayed in the Gallery deck.

The Gallery default themes are read-only. No images or graphics can be added to or deleted from these themes. The default themes are easily identified by right-clicking on a theme name and the only available option in the context menu is **Properties**.

Custom themes

Custom themes, when added to the Gallery, are the only themes where images and graphics can be added. Custom themes are listed alphabetically, along with the default themes, in the box at the top of the Gallery deck on the Sidebar. Custom themes are easily identified by right-clicking on a theme name and the options available in the context menu are **Delete**, **Rename**, and **Properties**.

Custom themes can also be added to the Gallery to hold any images or graphics that are used frequently. For example, a company logo, or images and graphics that are used for specific projects.

Tip

Gallery themes are available from the LibreOffice extensions website at <https://extensions.libreoffice.org/>. This website also includes themes from previous versions of LibreOffice that are no longer installed when newer versions of LibreOffice are installed. See Chapter 13, Customizing LibreOffice for information on managing extensions.

Creating themes

- 1) Open the Gallery deck in the Sidebar using one of the following methods:
 - Go to **Insert > Media > Gallery** on the Menu bar.
 - Click on **Gallery** in the Sidebar.

- 2) Click **New** at the bottom of the Gallery deck and the Properties of New Theme dialog opens (Figure 122).
- 3) Click on **General** and type a name for the new theme in the text box.
- 4) Click **OK** to save the new theme and close the dialog. The new theme is displayed in the list of themes in the Gallery.

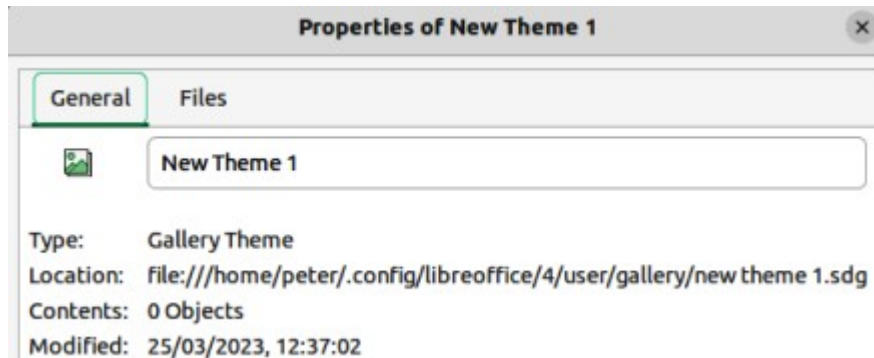

Figure 122: Properties of New Theme dialog — General page

Note

The name of the Properties of New Theme dialog changes to show the name of the newly created custom theme in the Gallery deck.

Adding images and graphics

- 1) Right-click on a custom theme name in the theme list on the Gallery deck and select **Properties** from the context menu to open the Properties of New Theme dialog.
- 2) Click on **Files** to open the Files page (Figure 123), then click on **Find Files** to open a Select Path dialog.

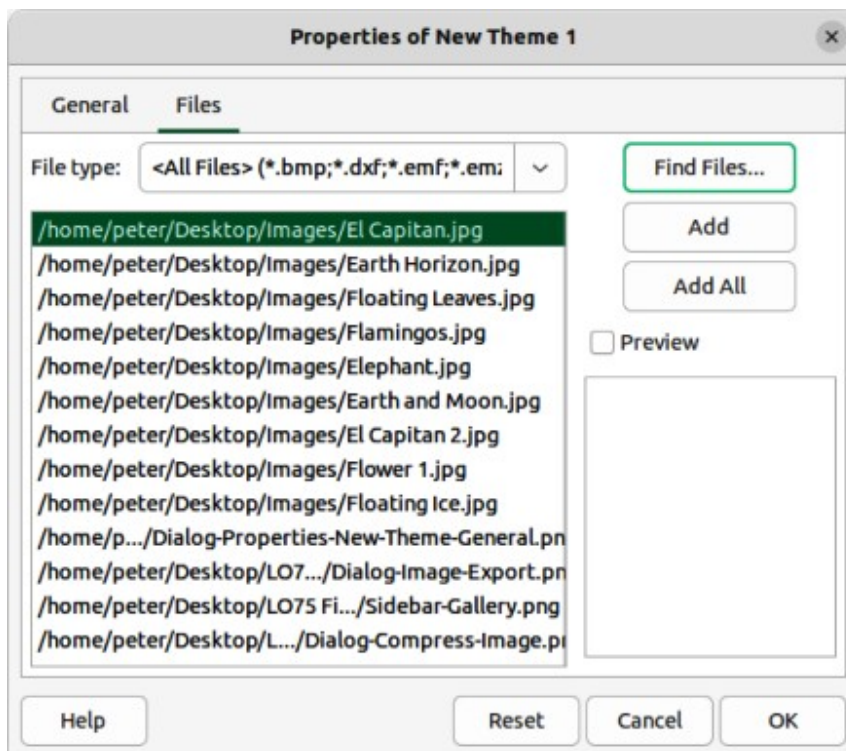

Figure 123: Properties of New Theme dialog — Files page

- 3) Navigate to the folder that contains the images and graphics required and select the folder.
- 4) Click **OK** to close the Select Path dialog. The files contained in the folder appear in the Properties of New Theme dialog.
- 5) If necessary, select **Preview** and any image or graphic selected appears in the preview box.
- 6) Select the files required for the custom theme and click on **Add**. The added files disappear from the file list and the images and graphics appear in the custom theme on the Gallery deck.
- 7) To add all the files in the list, then click **Add All**. All the files disappear from the list and the images and graphics appear in the custom them on the Gallery deck.
- 8) Click **OK** and close the Properties of New Theme dialog.

Deleting images and graphics

Only images and graphics added to a custom themes can be deleted.

- 1) Open the Gallery deck and select a custom theme.
- 2) Right-click on the image or graphic and select **Delete** from the context menu.
- 3) Click **Yes** in the confirmation message to delete the image.

Note

Images and graphics in custom themes are linked files and are deleted from the Gallery only. The original image and graphic files are not deleted.

Updating themes

All images and graphics in the Gallery are linked files. It is recommended that any custom themes are updated on a regular basis to make sure that all the files are still available.

- 1) Open the Gallery deck and select a custom theme that contains at least one image or graphic.
- 2) Right-click on the name of the selected custom theme.
- 3) Select **Update** from the context menu and the links to all the image and graphic files are updated.

Gallery images and graphics location

Images and graphics in the Gallery can be located anywhere on a computer, or a network drive. When adding graphics to the Gallery, the files are not moved or copied. Only the location of each image or graphic added to the Gallery is used as a reference.

The location of the Gallery is specified in **Tools > Options > LibreOffice > Paths** (macOS **LibreOffice > Preferences > LibreOffice > Paths**). If necessary, this location can be changed and gallery files (*.sdv) can be copied to other computers.

Gallery contents provided with LibreOffice are stored in a different location. You cannot change this location.

Note

The location of Gallery themes installed using LibreOffice extensions are determined by the extension settings.

Creating image maps

An image map defines areas of an image (called hotspots) with hyperlinks to web addresses, other files on the computer, or parts of the same document. Hotspots are the graphic equivalent of text hyperlinks (for more information, see Chapter 4, Working with Styles, Templates, and Hyperlinks).

Clicking on a hotspot causes LibreOffice to open the linked page in the appropriate program (for example, the default browser for an HTML page; LibreOffice Calc for an ODS file; a PDF viewer for a PDF). Hotspots can be in various shapes and several hotspots can be included on the same image.

Image map editor

- 1) In a LibreOffice document, select the image where hotspots are going to be defined.
- 2) Go to **Tools > ImageMap** on the Menu bar to open the ImageMap Editor dialog (Figure 124). The main part of the dialog displays the image where hotspots are to be defined.
- 3) Use the tools and fields in the dialog to define the required hotspots and links. A hotspot is identified by a line indicating its shape. The information needed for the hotspot includes the address pointed to by the hyperlink and the text to be displayed when the cursor is moved over the hotspot.
- 4) Click on **Apply** to apply the settings.
- 5) Click **Save** to save the image map to a file, then close the dialog.

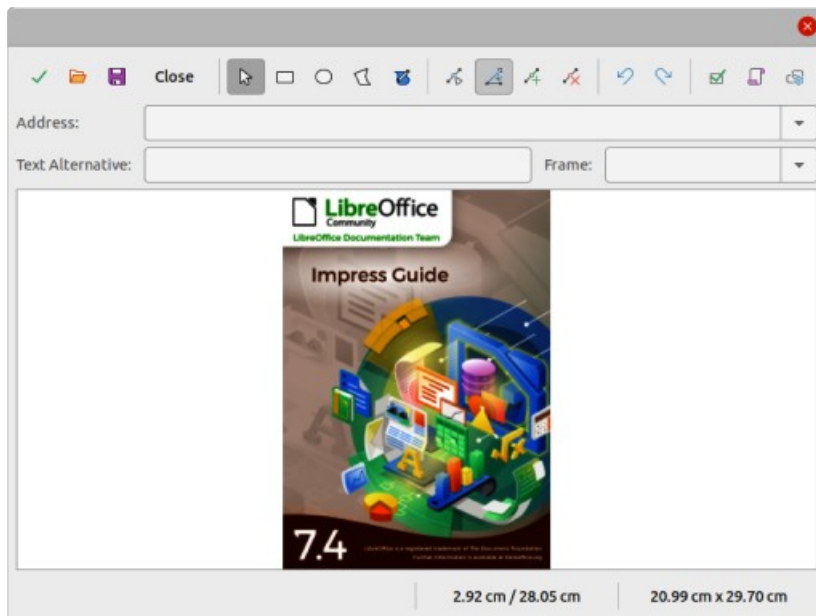

Figure 124: Image Map Editor dialog

Image map tools

The toolbar at the top of the dialog contains the following tools and text boxes to specify the properties of an image map:

Apply

Applies any changes made.

Open

Opens a file browser window for navigating to a folder where an image map has been saved.

Save

Opens a file browser window for navigating to a folder where the image map is to be saved.

Close

Closes the Image Map dialog. A confirmation window opens asking for confirmation of what happens to any changes that have been made.

Select

Used to select a hotspot that has been created on an image.

Rectangle, Ellipse, Polygon and FreeForm Polygon

Drawing tools for hotspot shapes. These tools work in exactly the same way as the corresponding tools in the Drawing toolbar.

Edit Points, Move Points, Insert Points, Delete Points

Advanced editing tools to manipulate the shape of a polygon hotspot. Select **Edit Points** first to activate the other points tools.

Undo

Reverses any previous action taken.

Redo

Carries out any action that has been previously undone.

Active

Toggles the status of the hotspot activating a selected hotspot or deactivating it if active.

Macro

Associates a macro with the hotspot instead of a hyperlink.

Properties

Sets the hyperlink properties and adds the Name attribute to the hyperlink.

Address

Enter the URL address that points to a hyperlink, or to an anchor in a document (for example a specific slide number). Using an anchor in a document, write the address in this format: `file:///<path>/document_name#anchor_name`.

Text

Enter the text that is displayed when the cursor is moved over the hotspot.

Frame

Where the target of the hyperlink opens.

_blank

Opens in a new browser window.

_self

Default selection and opens in the current window.

_top

File opens in the topmost frame in the hierarchy.

`_parent`

File opens in the parent frame of the current frame. If there is no parent frame, the current frame is used.

Note

The value `_self` for the target frame works in the vast majority of occasions. It is not recommended to use the other selections unless absolutely necessary.

LibreOffice drawing tools

Drawing tools in LibreOffice are used to create graphics consisting of rectangles, circles, lines, text, and other predefined shapes. Also several graphics can be grouped to maintain their relative position and proportion with each other. Graphics are placed directly on a page in a document, or inserted into a frame.

Tip

When creating complex drawings, it is recommended to use LibreOffice Draw to make use of more advanced drawing features, for example drawing layers and styles.

Drawing toolbar

An example Drawing toolbar is shown in Figure 125. If the Drawing toolbar is not displayed, it can be opened by going to **View > Toolbars > Drawing** on the Menu bar, or by clicking on **Show Draw Functions** on the Standard toolbar.

The default tools available on a Drawing toolbar do vary slightly between the LibreOffice modules. Tools can be added to a Drawing toolbar using **Visible Buttons**, or customizing the toolbar. See Chapter 12, Configuring LibreOffice, Chapter 13, Customizing LibreOffice for more information, or the specific user guide for each LibreOffice module.

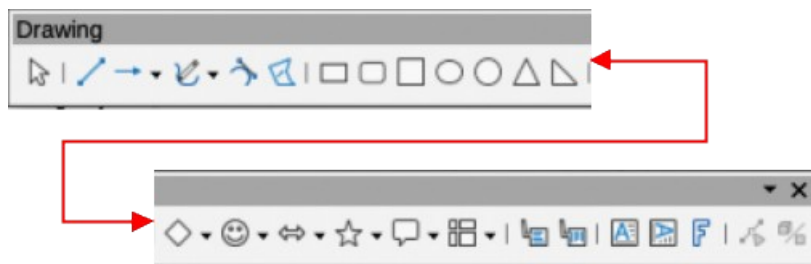

Figure 125: Drawing toolbar — Writer module

Drawing tools numbered from left to right for Figure 125

- | | | |
|------------------------|------------------------|--------------------------|
| 1) Select | 10) Ellipse | 19) Flowchart |
| 2) Insert Line | 11) Circle | 20) Callouts |
| 3) Lines and Arrows | 12) Isosceles Triangle | 21) Vertical Callouts |
| 4) Curves and Polygons | 13) Right Triangle | 22) Insert Text Box |
| 5) Curve | 14) Basic Shapes | 23) Insert Vertical Text |
| 6) Polygon | 15) Symbol Shapes | 24) Insert Fontwork Text |
| 7) Rectangle | 16) Block Arrows | 25) Points |
| 8) Rectangle, Rounded | 17) Stars and Banners | 26) Toggle Extrusion |
| 9) Square | 18) Callout Shapes | |

Note

The following procedures are examples only using LibreOffice Writer. Actual procedures depend on the LibreOffice module being used, computer operating system, and computer setup.

Inserting drawing objects

- 1) Click in the document at the position where the drawing is to be placed.
- 2) Select the drawing required tool on the Drawing toolbar and the following happens:
 - The cursor changes shape to indicate drawing mode is selected.
 - The Formatting toolbar changes to the Drawing Object Properties toolbar (Figure 126).
- 3) Click and drag to create the drawing object using the default properties.
- 4) Release the cursor and the selected drawing tool remains active. This allows drawing another object of the same type.
- 5) If necessary, select another drawing object to draw a different shape of drawing object.
- 6) Press the *Esc* key, or deselect the drawing object to cancel drawing mode.

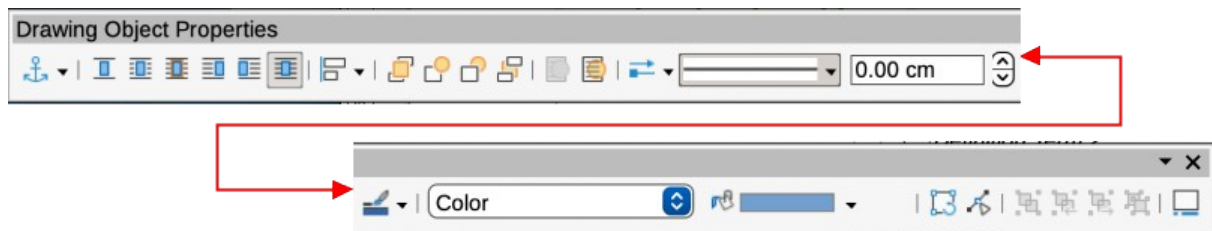

Figure 126: Drawing Object Properties toolbar

Drawing object properties numbered from left to right for Figure 126

- | | | |
|-----------------------------|--|--------------------|
| 1) Select anchor for object | 11) Back One | 20) Fill Color |
| 2) None | 12) Send to Back | 21) Rotate |
| 3) Parallel | 13) To Foreground | 22) Points |
| 4) Optimal | 14) To Background | 23) Group |
| 5) Before | 15) Select start and end
arrowheads for lines | 24) Enter Group |
| 6) After | 16) Line Style | 25) Exit Group |
| 7) Through | 17) Line Width | 26) Ungroup |
| 8) Align Objects | 18) Line Color | 27) Insert Caption |
| 9) Bring to Front | 19) Area Style/Filling | |
| 10) Forward One | | |

Changing properties

- 1) Click on **Select** on the Drawing toolbar, then select the drawing object.
- 2) On the Drawing Object Properties toolbar, select each property tool required for the drawing object.
- 3) If necessary, select the property value from the available options.
- 4) Select the type of drawing object required on the Drawing toolbar.
- 5) Click and drag to create the drawing object using the selected properties.
- 6) To change properties for another drawing object, repeat Steps 2 and 3 before drawing the object.
- 7) Press the *Esc* key, or deselect the drawing object to cancel drawing mode.

Editing drawing objects

Editing drawing objects uses the same procedures that are used for editing images and graphics. See “Images and graphics” above for more information.

Grouping objects

This section gives only a brief introduction to grouping of objects. An example of grouping two objects together is shown in Figure 127. For more information on working with grouped objects, see the specific user guide for each LibreOffice module.

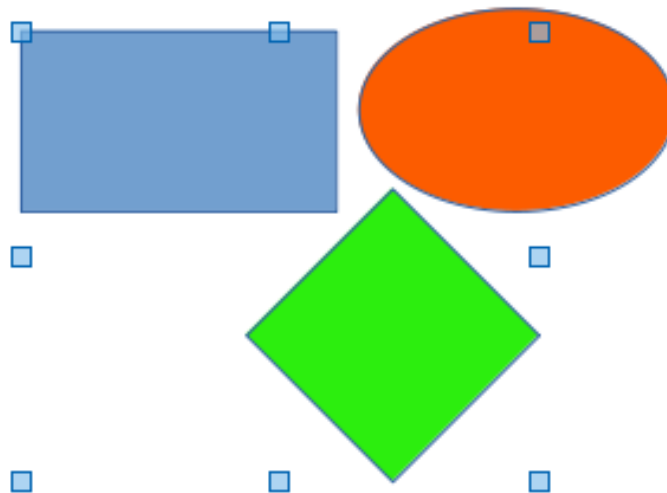

Figure 127: Example of grouping objects

Grouping of objects is similar to putting objects into a container. Objects within a group are moved together as one object and any changes made are applied globally to the objects within the group. A group can always be undone and the objects that make up the group can always be manipulated separately.

Temporary grouping

Temporary grouping is when several objects are selected together. Any changes to the objects are applied to all of the objects within the temporary group. For example, a temporary group of objects can be rotated in its entirety.

A temporary group is created using one of the following methods:

- Hold down the *Shift* key whilst clicking multiple objects on a slide.
- Click and drag the cursor to create a marquee around multiple objects. Release the cursor and all the objects within the marquee are selected.

To cancel a temporary grouping of objects, simply click outside of the selection handles displayed around the objects.

Permanent grouping

1) Objects are grouped together using one of the following methods:

- Hold down the *Shift* key whilst clicking multiple objects on a slide.
- Click and drag the cursor to create a marquee around multiple objects. Release the cursor and all the objects within the marquee are selected.

- To select all the objects on the slide, go to **Edit > Select All** on the Menu bar, or use the keyboard shortcut *Ctrl+A* (macOS $\text{⌘}+A$).
- 2) With selection handles displayed, use one of the following methods to create a group of selected objects:
 - Go to **Format > Group > Group** on the Menu bar.
 - Use the keyboard shortcut *Ctrl+Shift+G* (macOS $\text{⌘}+Shift+G$).
 - Right-click on an object within the selected group and select **Group** from the context menu.

Editing or formatting groups

- 1) Click on an object in the group to select the group. Any editing or formatting can then be carried out on all the objects within the group or on individual objects within the group.
- 2) To edit an individual object within a group, enter the group using one of the following methods:
 - Use the keyboard shortcut *F3*.
 - Go to **Format > Group > Enter Group** on the Menu bar.
 - Right-click and select **Enter Group** from the context menu.
- 3) Select individual objects within the group for editing or formatting. An example of editing individual objects in a group is shown in Figure 128.
- 4) When editing or formatting is completed, use one of the following methods to exit the group and the whole group then becomes selected:
 - Use the keyboard shortcut *Ctrl+F3* (macOS $\text{⌘}+F3$).
 - Go to **Format > Group > Exit Group** on the Menu bar.
 - Right-click and select **Exit Group** from the context menu.

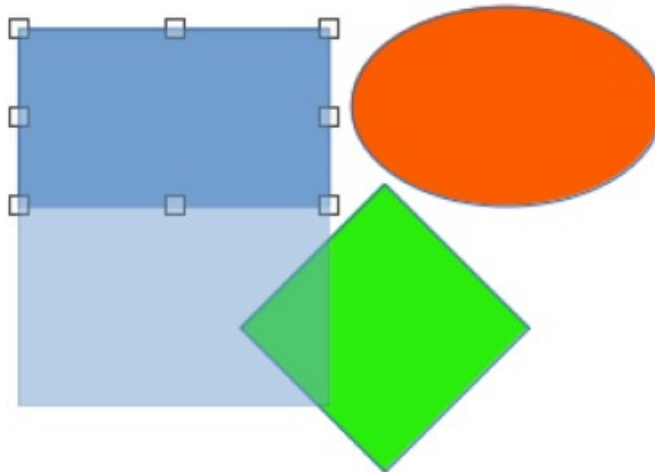

Figure 128: Example of editing inside a group

Ungrouping

- 1) Click on any one of the objects in the group to select the group.
- 2) With selection handles displayed, use one of the following methods to ungroup a group of objects:

- Go to **Format > Group > Ungroup** on the Menu bar.
- Use the keyboard shortcut *Ctrl+Alt+Shift+G* (macOS $\text{⌘}+\text{⌥}+\text{⇧}+G$).
- Right-click on the group and select **Ungroup** from the context menu.

Fontwork

With Fontwork, graphical text art objects can be created to make a document more attractive. There are many different settings for text art objects (line, area, position, size, and more) giving a large selection of effects. Fontwork is available with the Writer, Calc, Draw, and Impress modules of LibreOffice, but there are small differences in the way that each module displays Fontwork.

- 1) Click on **Insert Fontwork Text** on the Drawing toolbar, or go to **Insert > Fontwork** on the Menu bar to open the Fontwork Gallery dialog (Figure 129).



Figure 129: Fontwork Gallery dialog

- 2) Select a Fontwork style from the dialog and click **OK**. The selected Fontwork appears centrally on the page and the dialog closes.
- 3) Double-click on the Fontwork text graphic to switch on editing mode.
- 4) Type in the required text to replace the default text in the Fontwork graphic and the text appears over the default text as shown by the example in Figure 130.
- 5) Press *Esc* key, or click outside the Fontwork graphic and the text replaces default text.



Figure 130: Example of creating Fontwork

Fontwork toolbar

The Fontwork toolbar (Figure 131) becomes visible and active when a Fontwork object is selected. If the toolbar is not visible, go to **View > Toolbars > Fontwork** on the Menu bar. Also, the **Fontwork** panel opens in the Properties deck on the Sidebar and contains the same tools as the Fontwork toolbar.

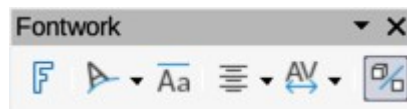

Figure 131: Fontwork toolbar

Insert Fontwork Text

Opens the Fontwork Gallery dialog.

Fontwork Shape

Changes the shape of the selected object. Clicking on the triangle ▼ next to **Fontwork Shape** opens the Fontwork Shape sub-toolbar (Figure 132) allowing selection of different Fontwork shapes.



Figure 132: Fontwork Shape sub-toolbar

Fontwork Same Letter Heights

Changes the height of characters in the selected Fontwork object. Toggles between normal height where the characters have different heights to where all characters have the same height.

Fontwork Alignment

Specifies the text alignment within the frame. Options available are *Left Align*, *Center*, *Right Align*, *Word Justify*, and *Stretch Justify*. The effects of the text alignment can only be seen if the text spans over two or more lines. In the *Stretch Justify* mode, all lines are filled completely.

Fontwork Character Spacing

Selects the spacing between characters and whether kerning pairs are used. Options available are *Very Tight*, *Tight*, *Normal*, *Loose*, *Very Loose*, and *Custom Spacing*. For *Custom Spacing*, input a percentage value: 100% is normal character spacing, less than 100% character spacing is tighter, and more than 100% character spacing is looser.

Toggle Extrusion

Converts the Fontwork object into a 3D shape using extrusion. See the *Draw Guide* for more information.

Editing Fontwork

It is possible to treat Fontwork text as an object and apply all the formatting that has been described in this chapter. Assign line properties only to Fontwork that does not have a 3D effect, otherwise the changes are not visible. Also, modify some of the Fontwork shapes by moving the dot that is displayed along with the selection handles. This is similar to modification of the angles of trapezoid and parallelogram basic shapes.

Barcodes and QR codes

Writer, Calc, Impress, and Draw can generate barcodes and QR (Quick Response) codes. Barcodes are used for many purposes to easily identify items using a code scanner. QR codes are a type of barcode containing, for example, data that points to a website or application.

Generating

- 1) Go to **Insert > OLE Object > QR and Barcode** on the Menu bar to open the QR and Barcode Code dialog.
- 2) Enter the required information in the URL/Text field. This can be, for example, a website address, or a product number.
- 3) Select the error correction factor from the options available in *Error correction*. This is the complexity of the graphic generated.
- 4) Enter the margin required in the *Margin* text box. The margin is placed around the code when it is generated.
- 5) Select the type of code from the options available in the *Type* drop-down list.
- 6) Click **OK** to generate the code and close the QR and Barcode dialog.

Options

URL/Text:

Error correction: Low
 Medium
 Quartile
 High

Margin:

Type:



Figure 133: Example QR code

Options

URL/Text:

Error correction: Low
 Medium
 Quartile
 High

Margin:

Type:



Figure 134: Example Barcode

Editing

- 1) After the barcode, or QR code has been generated, right-click in the code and select **Edit Barcode** from the context menu to open the QR and Barcode dialog.
- 2) Make the necessary changes to the information in the QR and Barcode dialog.
- 3) Click **OK** to regenerate the code and close the QR and Barcode dialog.



LibreOffice
Community



Chapter 6, Getting Started with Impress

Presentations in LibreOffice

What is Impress?

Impress is the presentation (slide show) program included in LibreOffice creating presentations in the Open Document Presentation (ODP) format. ODP presentations can be opened by other presentation software, or exported in different presentation formats.

Slides can contain many different elements, including text, bulleted and numbered lists, tables, charts, and a wide range of graphic objects such as clip art, drawings, and photographs. Impress also includes a spelling checker, a thesaurus, text styles, and background styles.

This chapter introduces some features of Impress and does not attempt to cover all of the features available in Impress that can be used to create presentations. See the *Impress Guide* and LibreOffice Help for more information.

To use Impress for more than very simple presentations requires some knowledge of the elements used on the slides. Slides containing text use styles to determine the appearance of that text. Creating drawings in Impress is similar to the Draw module included in LibreOffice. For more information, refer to Chapter 4, Working with Styles, Templates, and Hyperlinks, and Chapter 7, Getting Started with Draw, in this guide. It is recommended to consult the *Draw Guide* for more details on how to use the drawing tools.

Starting Impress

Start Impress using any of the methods described in Chapter 1, LibreOffice Basics. The main Impress window opens and, by default, the Select a Template dialog (Figure 135) displaying templates installed with LibreOffice.

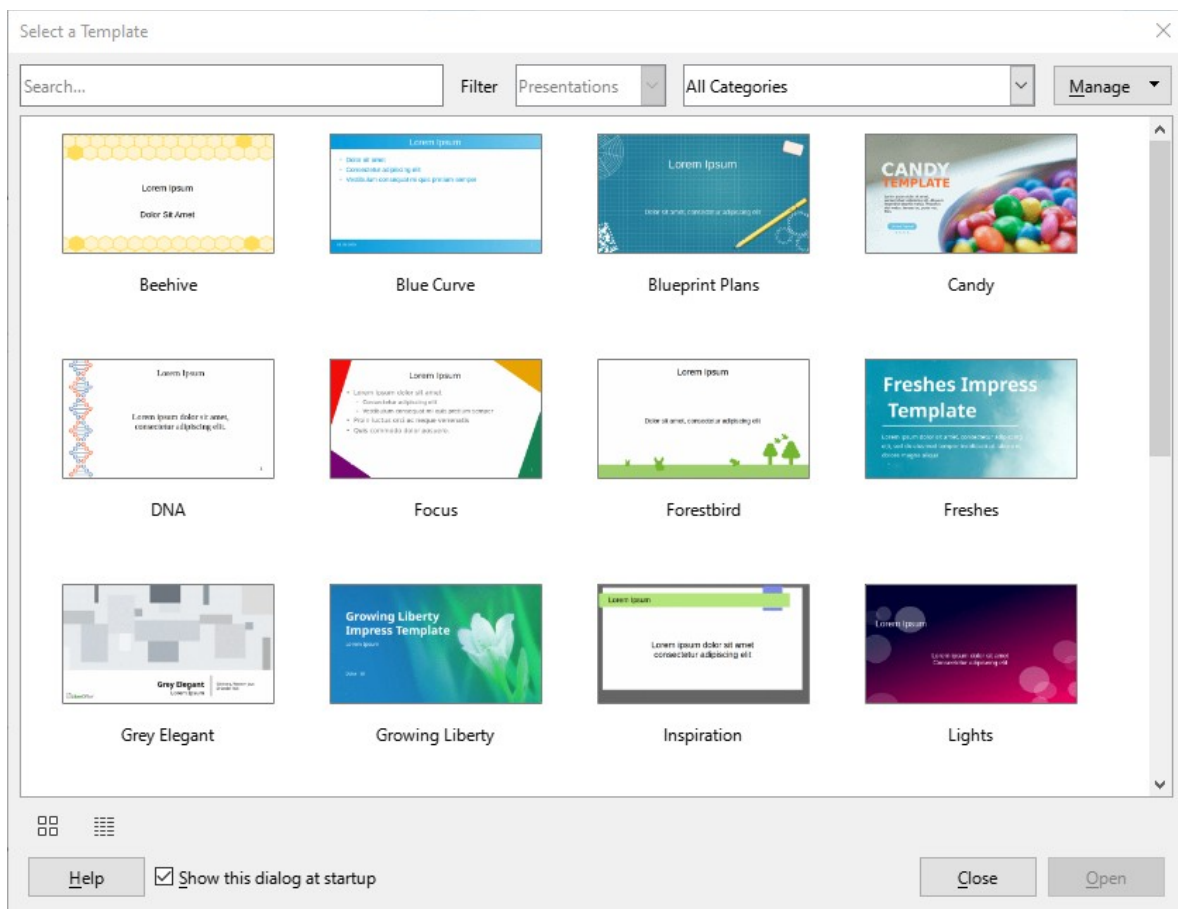

Figure 135: Select a Template dialog

Templates included with Impress are designed to fit the two standard sizes of presentation slides using 4:3 and 16:9 ratios. The templates do adapt to other available sizes, which are selected by going to **Slide > Slide Properties > Paper Format** on the Menu bar or *Format* in the **Slide** panel in the Properties deck on the Sidebar.

Tips

To start Impress without the Select a Template dialog, deselect *Show this dialog box at startup* in the lower left of the dialog.

In Windows or Linux, go to **Tools > Options > LibreOffice Impress > General** on the Menu bar (macOS **LibreOffice > Preferences > LibreOffice Impress > General**) and deselect *Start with Template Selection* under **New Document**.

The Slides pane and/or Sidebar can be closed by clicking the **X** in the upper right corner of each pane, or go to **View > Slide Pane** or **View > Sidebar** on the Menu bar to deselect. To reopen a pane, select **View > Slide Pane** or **View > Sidebar** on the Menu bar.

Main Impress window

The main Impress window (Figure 136) has three main sections: Slides pane, Workspace, and Sidebar. At the top is the Menu bar and toolbars. Toolbars can be displayed, hidden, locked in position, or floating during the creation of a presentation.

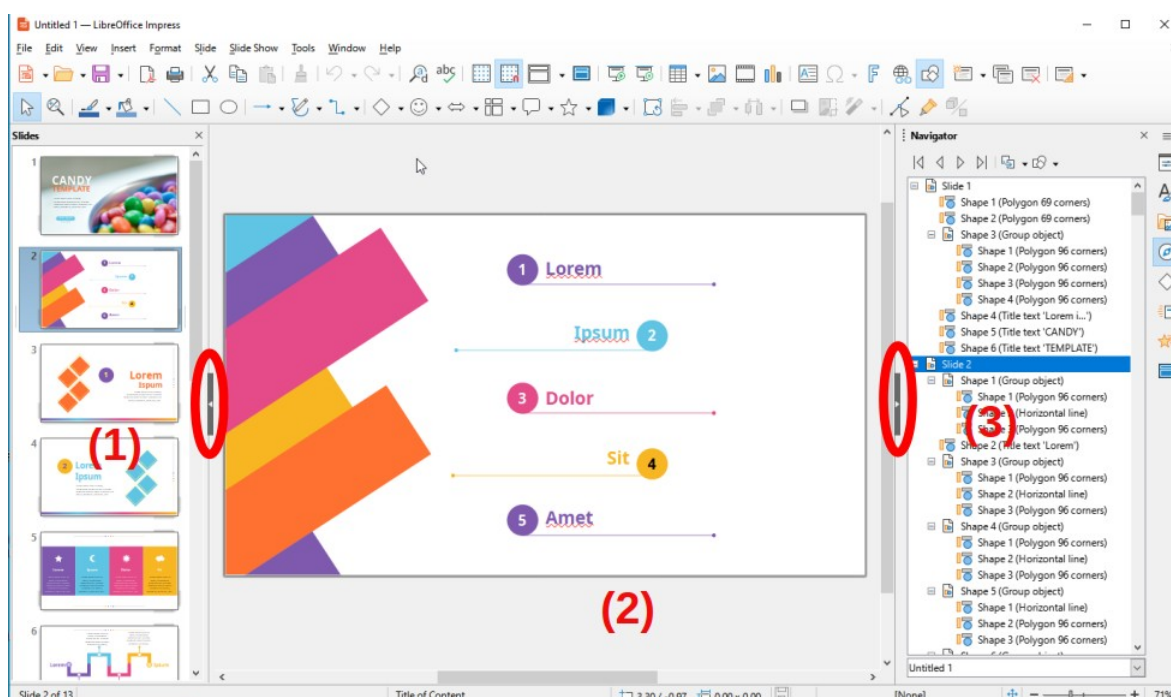

Figure 136: Main Impress window

1) Slides pane

2) Workspace

3) Sidebar

Menu bar

The Impress Menu bar, at the top of the main window, provides several menus common to all LibreOffice modules. The commands may differ between each LibreOffice module for **File**, **Edit**, **View**, **Insert**, **Format**, **Tools**, **Window**, and **Help**. Impress has two extra menus for **Slide** and **Slide Show**. When a menu item is selected, a submenu opens to show commands. The Menu bar can be customized; see Chapter 13, Customizing LibreOffice.

Workspace

The Workspace (normally the center of the main window) opens in **Normal** view. It has four standard views of **Normal**, **Outline**, **Notes**, and **Slide Sorter**. For more information, see “Workspace views” on page 235.

If master slides are used, then master views become available: **Master Slide**, **Master Notes** and **Master Handout**. There are no tabs for master views and are selected by going to **View** on the Menu bar. For more information on master slides, see the *Impress Guide*.

Slides pane

The Slides pane contains thumbnail images of slides in a presentation in the order in which the slides are shown. Clicking on a slide image in the Slides pane selects it and places the slide in the Workspace where changes are made to the displayed slide.

- To display or close the Slides pane, go to **View > Slide Pane** on the Menu bar.
- To close the Slides pane, click on the **X** in the right top corner of the Slides pane.
- To display or hide the Slides pane, use the **Hide/Show** marker on the left of the Workspace.

Several additional operations can be carried out on one or more slides in the Slides pane. Also, these additional operations are available from a context menu when right-clicking on a slide in the Slides pane.

- Add new slides to a presentation.
- Hide a slide so that it will not show in a presentation.
- Delete a slide from a presentation.
- Rename a slide.
- Duplicate a slide (copy and paste).
- Move a slide to another position in the slide order by dragging and dropping it to the desired position.

Also, the following operations can be carried out, although there are more efficient methods than using the Slides pane:

- Change the slide transition following the selected slide, or after each slide in a group.
- Change the sequence of slides in the presentation.
- Change the slide design.
- Change slide layout for a group of slides simultaneously.

Sidebar

The Sidebar, normally located on the right side of the Workspace, is similar to the Sidebar in the other LibreOffice module and consists of eight decks. To display or hide the Sidebar, use one of the following methods:

- 1) Go to **View > Sidebar** on the Menu bar.
- 2) Use the keyboard shortcut *Ctrl+F5* (macOS +F5).
- 3) Use the **Hide/Show** marker on the right of the Workspace (Figure 136 on page 229).
- 4) To hide the Sidebar, click on the **X** in the right top corner of the Sidebar.
- 5) To display the Sidebar, click on one of the Sidebar icons to open a deck.

To open a Sidebar deck, use one of the following methods:

- Click on its icon on the right side of the Sidebar.
- Click on **Sidebar Settings** at the top of the Sidebar and select a deck from the drop-down list.
- Use one of the available keyboard shortcuts for Sidebar decks.

Properties

The Properties deck (*Ctrl+Alt+1*, macOS $\text{⌘}+\text{⇧}+1$) has ten panels, allowing changes to slide layout and formatting of slide objects.

- When a slide is selected and appears in the Workspace, the Properties deck opens with the **Slide** and **Layouts** panels available.
- When a slide object is selected, the panels in the Properties deck become available: **Character, Lists, Paragraph, Area, Shadow, Line, Position and Size, Columns, Effect**, and **Image**. Actual panels displayed depends on the type of object selected.

Styles

In the Styles deck (*Ctrl+Alt+2*, macOS $\text{⌘}+\text{⇧}+2$), drawing and presentation styles are applied to a selected object, new styles created for drawing and presentation, and formatting changes to both types of styles. When saving changes to a style, the changes are applied to all of the elements formatted with that style in the presentation. For more information on styles, see “Styles” on page 258 and the *Impress Guide*.

Gallery

Using the Gallery deck (*Ctrl+Alt+3*, macOS $\text{⌘}+\text{⇧}+3$), an object is inserted into a presentation either as a copy or as a link. A copied object is independent of the original object. Changes to the original object have no effect on the copy. A link remains dependent on the original object. Changes to the original object are also reflected in the linked object. See the *Impress Guide* for more information.

Navigator

The Navigator deck (*Ctrl+Alt+4*, macOS $\text{⌘}+\text{⇧}+4$) displays all objects contained in a presentation. It provides a convenient way to move between slides in a presentation, or select an object on a slide. It is recommended to give slides and objects in a presentation meaningful names for easy identification when using the Navigator. For more information, see “Navigator” on page 234 and the *Impress Guide*.

Shapes

The Shapes deck (*Ctrl+Alt+5*, macOS $\text{⌘}+\text{⇧}+5$) provides panels for quick selection of basic shapes that are available on the Drawing toolbar: **Lines and Arrows, Curves and Polygons, Connectors, Basic Shapes, Symbol Shapes, Block Arrows, Flowchart, Callout Shapes, Stars and Banners**, and **3-D Objects**.

Slide transition

The Slide Transition deck (*Ctrl+Alt+6*, macOS $\text{⌘}+\text{⇧}+6$) provides a selection of slide transitions used in a presentation. There are controls to adjust transition speed, automatic or manual transition, and how long a selected slide is shown (automatic transition only). For more information on transitions, see “Slide transition” on page 271 and the *Impress Guide*.

Animation

The Animation deck (*Ctrl+Alt+7*, macOS $\text{⌘}+\text{⌘}+7$) is used to add, change, or remove animations for different elements or objects on a slide and adjust how objects appear during a slide show. For more information on animation effects, see “Animation effects” on page 273 and the *Impress Guide*.

Master slides

The Master Slides deck (*Ctrl+Alt+8*, macOS $\text{⌘}+\text{⌘}+8$) provides access to slide designs for presentations and several designs of master slides are available. The default master slide is blank, but the remaining master slides have backgrounds and styled text. For more information on master slides, see “Working with master slides” on page 258 and the *Impress Guide*.

Rulers

Rulers are positioned on the upper and left-hand sides of the Workspace. If the rulers are not visible, go to **View > Rulers** on the Menu bar. The rulers show the size of a selected object on the slide using double lines (highlighted in Figure 137). Rulers are also used to manage object handles and guide lines when positioning objects.

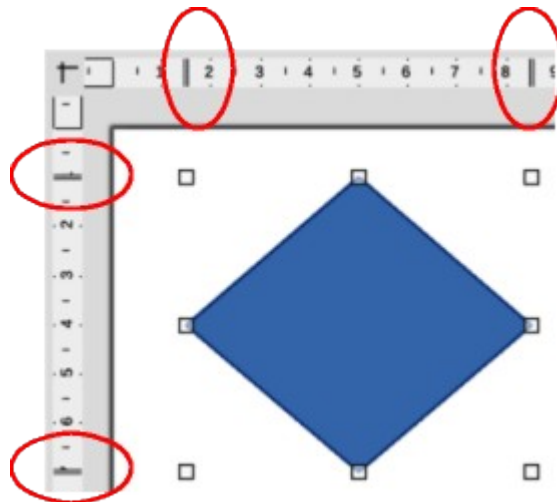

Figure 137: Rulers showing object size

To change the measurement units of the rulers, right-click on a ruler and select the measurement unit from the drop-down list, as shown in Figure 138 for the horizontal ruler. The horizontal and vertical rulers can be set to different measurement units.

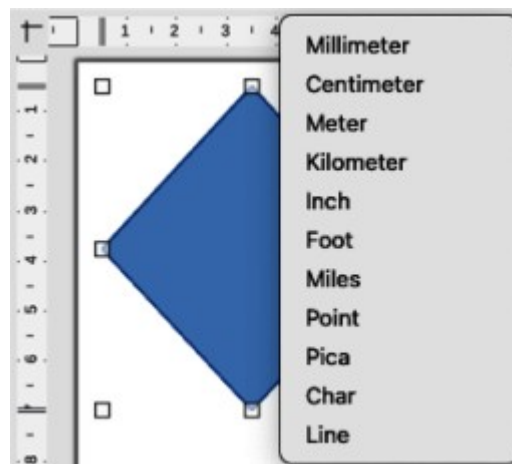

Figure 138: Changing ruler units

The page margins in the drawing area are also represented on the rulers. The margins can be changed directly on the rulers by dragging them with the mouse. The margin area is indicated by either a grayed out area on the rulers or borders around the unused area of the ruler. This margin indication depends on computer setup and operating system.

Status bar

The Status bar (Figure 139), located at the bottom of the Impress window, contains information that maybe useful when working on a presentation. Several of the fields are the same as those in other modules of LibreOffice. Some Impress specific fields are described briefly below.

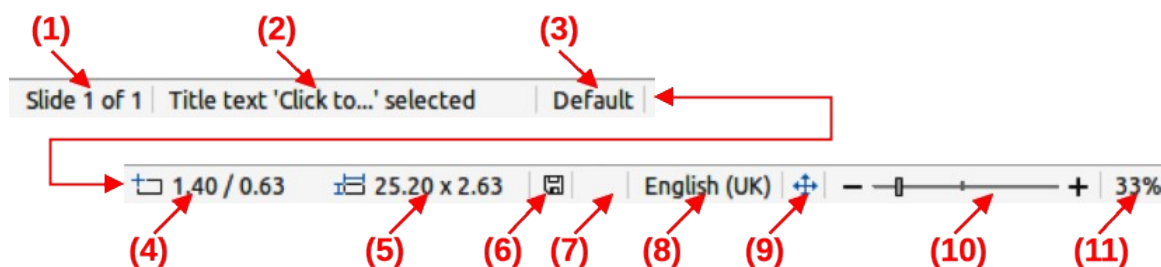

Figure 139: Status bar

- | | | |
|---------------------|----------------------|---------------------|
| 1) Slide Number | 5) Object size | 9) Fit slide |
| 2) Information area | 6) Unsaved changes | 10) Zoom slide |
| 3) Master slide | 7) Digital signature | 11) Zoom percentage |
| 4) Cursor position | 8) Text language | |

For details on the contents and use of these fields, see Chapter 1, LibreOffice Basics, in this guide and the *Impress Guide*. To hide the Status bar, go to **View** on the Menu bar and deselect **Status Bar**.

Slide number

The slide number currently displayed in the Workspace and the total number of slides in the presentation.

Information area

This changes depending on the object selected on the slide. Examples of the information displayed are shown in Table 11.

Table 11: Examples of information on Status Bar

Example selection	Examples of information shown
Text area	Text Edit: Paragraph x, Row y, Column z
Charts, spreadsheets	Embedded object (OLE) "ObjectName" selected
Graphics	Bitmap with transparency selected

Master slide

The master slide associated with the slide or notes page currently displayed in the Workspace. Right-click to open a list of available master slides and select one to apply it to the selected slide. Double-click to open the Available Master Slides dialog. For more information on master slides, see "Working with master slides" on page 258 and the *Impress Guide*.

Cursor position/Object size

Shows different information depending on whether objects are selected or not. When an object is selected, clicking in either of these areas opens the Position and Size dialog.

- When no object is selected, the position numbers show the current position (X and Y coordinates) of the cursor.

- When an object is selected and resized using the cursor, the object size numbers show the size of the object (width and height).
- If an object is selected, the position numbers show X and Y coordinates of the object upper-left corner and the object size number pair displays the size of the object. These numbers do not relate to the object itself, but to the selection outline, which is the smallest possible rectangle that can contain the visible part or parts of an object.

Unsaved changes

Indicates if there are any unsaved changes in the presentation. Clicking on this icon saves the document. If the presentation has not been saved before, the Save As dialog opens giving the opportunity to save the presentation.

Digital signatures

Indicates if the presentation has a digital signature.

Text language

Indicates the language used for any text on a presentation.

Fit slide

When this icon is clicked on, the displayed slide in the Workspace zooms to fit in the Workspace.

Zoom slider

When moved, the slide displayed in the Workspace adjusts its viewing zoom in the Workspace.

Zoom percentage

Indicates the zoom level of the slide displayed in the Workspace. Clicking on zoom percentage opens the Zoom & View Layout dialog where the settings for zoom factor and view layout are adjusted.

Navigator

The Navigator displays all objects contained in a presentation providing a convenient way to move around a presentation find items in the presentation, and reorder objects on slides.

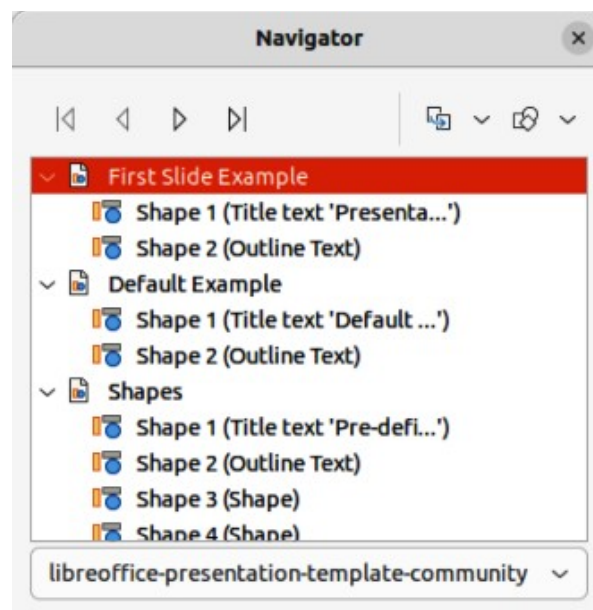



Figure 140: Navigator dialog

To open the Navigator dialog (Figure 140) go to **View > Navigator** on the Menu bar, or use the keyboard shortcut *Ctrl+Shift+F5* (macOS +*Shift+F5*). Alternatively, click on **Navigator** in the Sidebar to open the Navigator deck which is similar in appearance and function as the Navigator dialog.

The Navigator is more useful if slides and objects (pictures, spreadsheets, and so on) are given meaningful names, instead of leaving them with default names, for example “Slide 1” and “Shape 1” and so on (as shown in Figure 140). Using meaningful names allows for a slide or object to be easily located in a presentation.

Toolbars

Toolbars provide several tools that are used for creating slides for a presentation. To display or hide the various toolbars in Impress, go to **View > Toolbars** on the Menu bar and select the required toolbar in the submenu that opens. For example, the Standard and Drawing toolbars are displayed by default, but the Line and Filling, and Text Formatting toolbars are not shown. For more information on toolbars and how to use them, see Chapter 1, LibreOffice Basics, and the *Impress Guide*.

Note

The appearance of toolbar icons varies depending on the computer operating system, and the selection of icon size and style in **Tools > Options > LibreOffice > View** (macOS **LibreOffice > Preferences > Options > LibreOffice > View**).

Workspace views

The Impress workspace has four standard views selected using tabs: **Normal**, **Outline**, **Notes**, and **Slide Sorter**. These tabs are normally displayed the top of the Workspace (Figure 136 on page 229). If the tabs are not displayed, then go to **View > Views Tab Bar** on the Menu bar. Also, different workspace views can be selected by going to **View** on the Menu bar and selecting a view in the submenu. Each of the workspace views is designed to ease the completion of certain tasks.

Tip

The slide notes text box can be accessed in all views using **View – Notes Panel**.

Master views only become available in the Workspace when **Master Slide**, **Master Notes** or **Master Handout** are selected. There are no tabs for master views and can only be selected by going to **View** on the Menu bar.

Note

Each workspace view displays a different set of toolbars when selected. To customize these toolbar sets, go to **View > Toolbars** on the Menu bar, then check or uncheck the toolbars to add or remove.

Normal view

Normal view is the main standard view for creating individual slides in a presentation. In **Normal** view slides are designed, text or graphics added and formatted, and any animation effects added to text or graphics.

To place a slide in **Normal** view of the Workspace, either click on the slide thumbnail in the Slide Pane or click on the slide name in the Navigator.

Outline view

Outline view (Figure 141) contains all the slides of the presentation in their numbered sequence. It shows topic titles, bulleted lists, and numbered lists for each slide in outline format. Only the text contained in the default text boxes in each slide is shown. If text boxes or graphic objects have been added to the slides, then these objects are not displayed. Slide names are not included.

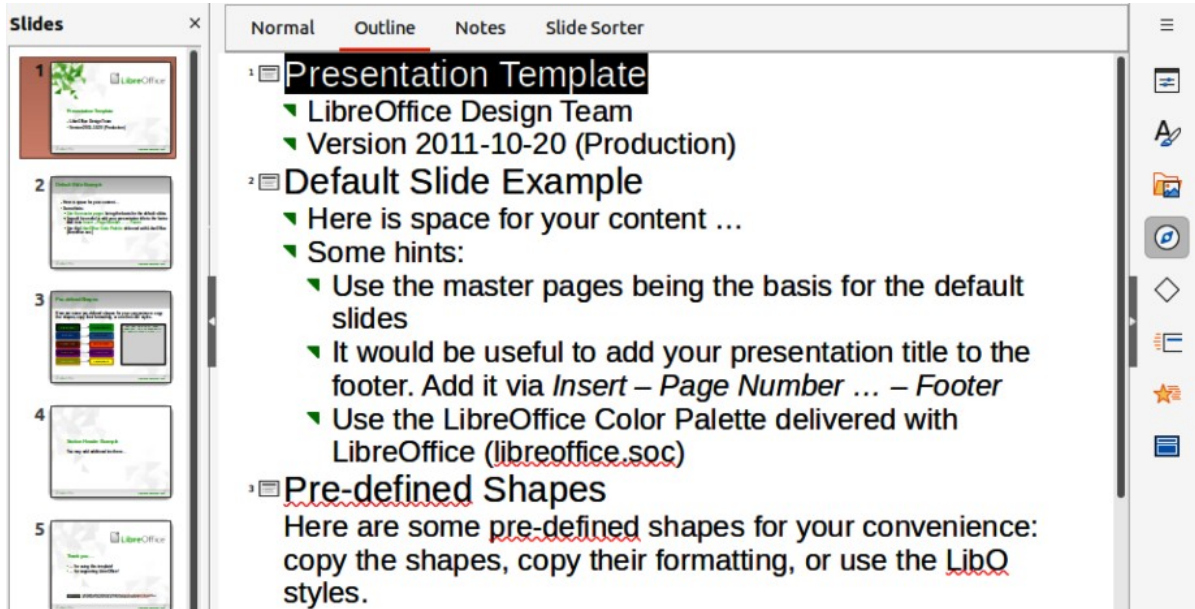

Figure 141: Example Outline view in Workspace

- Use **Outline** view for the following tasks:
 - Make changes in the text of a slide:
 - Add or delete text in a slide as in Normal view.
 - Move a paragraph in a slide up or down by using the movement arrows on the Outline toolbar (Figure 142).

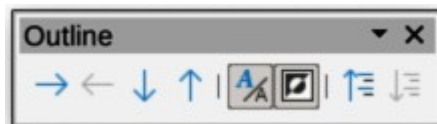

Figure 142: Outline toolbar

- Change the outline level of a paragraph in a slide using the left and right arrow buttons on the Outline toolbar.
- Compare slides with in an outline. If it is noticed in an outline that another slide is required, create it directly in **Outline** view, or return to **Normal** view to create it.

Notes view

Use **Notes** view (Figure 143) to add notes to a slide. These notes are not seen when the presentation is shown to an audience using an external display connected to a computer. Click on the words *Click to add Notes* and begin typing.

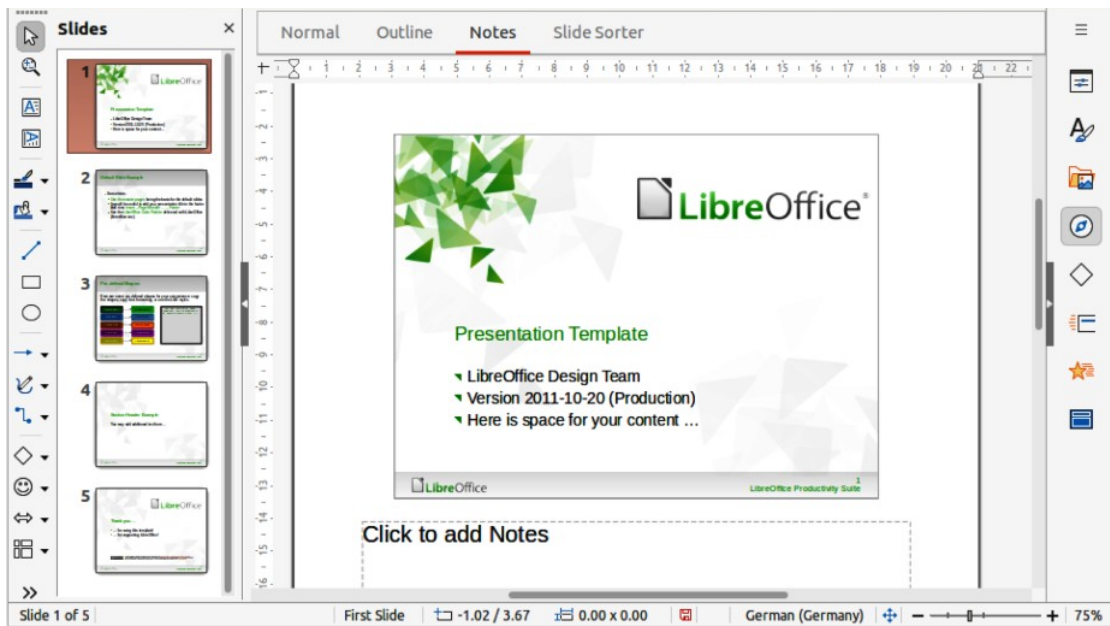

Figure 143: Example Notes view in Workspace

The *Click to add notes* text box can be resized using the resizing handles which appear when the edge of the notes box is selected. Move or change the size of the box by clicking and dragging on the box border.

When text is inserted in the *Click to add notes* text box, it is automatically formatted using the predefined *Notes* style in **Presentation Styles** in the Styles deck on the Sidebar. The *Notes* style can be formatted to the presentation requirements. For more information on editing styles, see Chapter 4, Working with Styles, Templates and Hyperlinks in this guide and the *Impress Guide*.

Slide sorter view

Slide Sorter view (Figure 144) contains all the thumbnails of slides used in a presentation. Use this view to work with one slide or a group of slides.

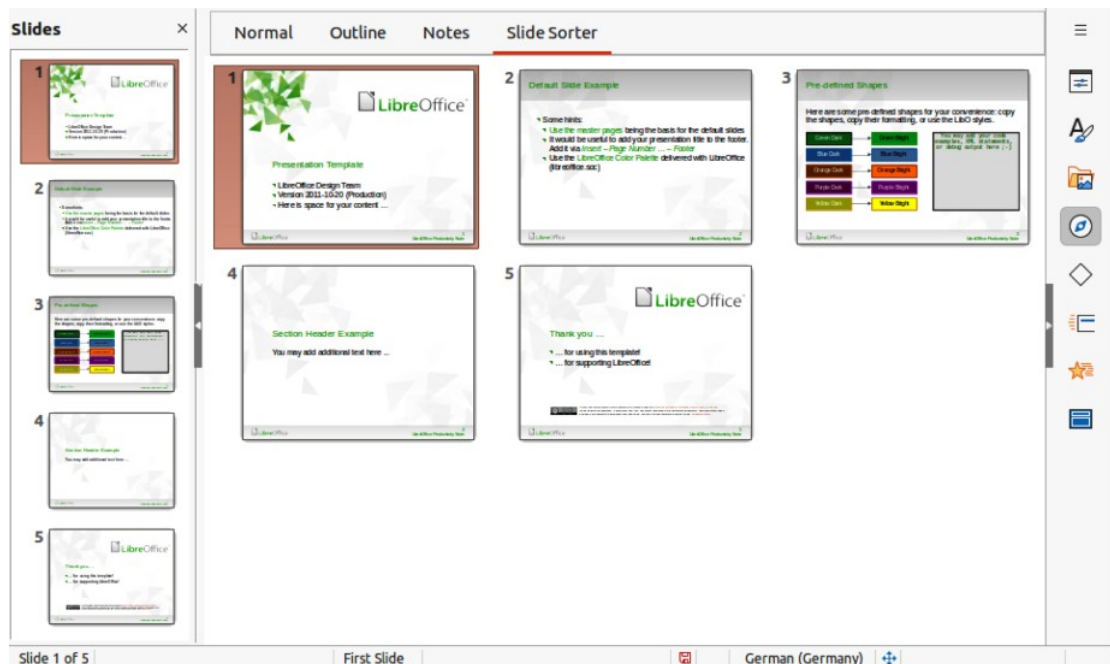

Figure 144: Example Slide Sorter view in Workspace

Customizing Slide Sorter view

To change the number of slides per row in **Slide Sorter** view:

- 1) Go to **View > Toolbars > Slide View** on the Menu bar to show the Slide View toolbar (Figure 145).
- 2) Adjust the number of slides, up to a maximum of 15, in the *Slides per Row* box.

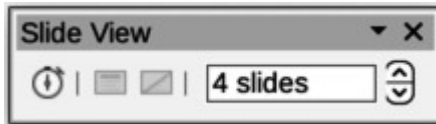

Figure 145: Slide View toolbar

Changing slide order

To change the slide order of one or a group of slides in a presentation using **Slide Sorter** view:

- 1) Select a slide or a group of slides.
- 2) Drag and drop the slide or group of slides at the location required.

Selecting a group of slides

To select a group of slides, use one of the following methods:

- *Ctrl* key — click on the first slide and, while holding the *Ctrl* key (macOS ⌘), select the required slides. The selected slides do not have to be next to each other.
- *Shift* key — click on the first slide, and while holding the *Shift* key, select the final slide for the group. This selects all of the slides between the first and the last slide selected.
- Click and drag — position the cursor slightly outside the first slide, then click and hold the left mouse button and drag the cursor until all of slides required for the group are selected.

Working in Slide Sorter view

Working with slides in **Slide Sorter** view is similar to working with slides in the Slide Pane. To make changes, right-click on a slide in **Slide Sorter** view and choose one of the following commands in Table 12:

Table 12: Slide Sorter commands

Command	Action
Cut	Removes the selected slide and saves it to the clipboard.
Copy	Copies the selected slide to the clipboard without removing it.
Paste	Inserts a slide from the clipboard after the selected slide.
New Slide	Adds a new slide after the selected slide.
Duplicate Slide	Creates a duplicate of the selected slide and places the new slide immediately after the selected slide.
Rename Slide	Renames the selected slide.
Hide Slide	Any slides that are hidden are not shown in the presentation.
Delete Slide	Deletes the selected slide.
Layout	Allows changes to the layout of the selected slide.
Move	Allows moving or repositioning of the slide in the presentation order.

Creating presentations

By default, Impress opens with the Select a Template dialog (Figure 135 on page 228) displayed allowing the selection of a template for a new presentation. To create a new presentation without a template, click on **Cancel** in the Select a Template dialog and a blank slide opens in the Workspace and Slides pane. For more information on creating presentations, slide show options, and presentation settings, see the *Impress Guide*.

Tip

The first thing to do is decide on the purpose of a presentation and plan accordingly. Having an idea of audience type, structure, content, and how the presentation will be delivered, saves a lot of time from the start.

New presentation

When creating a new presentation, Impress shows only one slide in the Slides pane and Workspace.

Inserting new slide

To insert a new slide into a presentation, use one of the following methods.

- Go to **Slide > New Slide** on the Menu bar.
- Right-click in the Slides pane and select **New Slide** in the context menu.
- Use the keyboard shortcut *Ctrl+M*.
- Go to Slide Sorter view in the Workspace, right-click on a slide and select **New Slide** in the context menu.
- Click on **New Slide** in the Presentation toolbar (Figure 146). If the Presentation toolbar is not visible, go to **View > Toolbars** on the Menu bar and select **Presentation** from the drop-down list.

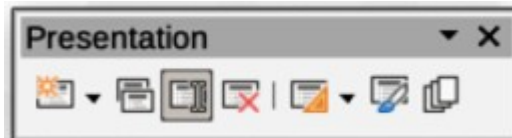

Figure 146: Presentation toolbar

Note

A new slide is inserted after the selected slide in the presentation. If a slide is not selected, then the new slide is inserted as the last slide in the presentation.

Duplicating slides

To duplicate a slide, select a slide for duplication in the Slides pane and use one of the following methods. A duplicate slide is inserted after the selected slide in the presentation.

- Right-click on a slide in the Slides pane and select **Duplicate Slide** in the context menu.
- Go to Slide Sorter view in the Workspace, right-click on a slide and select **Duplicate Slide** in the context menu.
- Go to **Slide > Duplicate Slide** on the Menu bar.
- Click on the **Duplicate Slide** icon on the Presentation toolbar.

Slide format

Click on **Properties** on the Sidebar and open the **Slide** panel (Figure 147) to display the format options available for a presentation. The **Slide** panel allows for quick formatting of all slides included in a presentation and selecting master slides for a presentation. For more information on formatting slides and using master slides, see the *Impress Guide*.

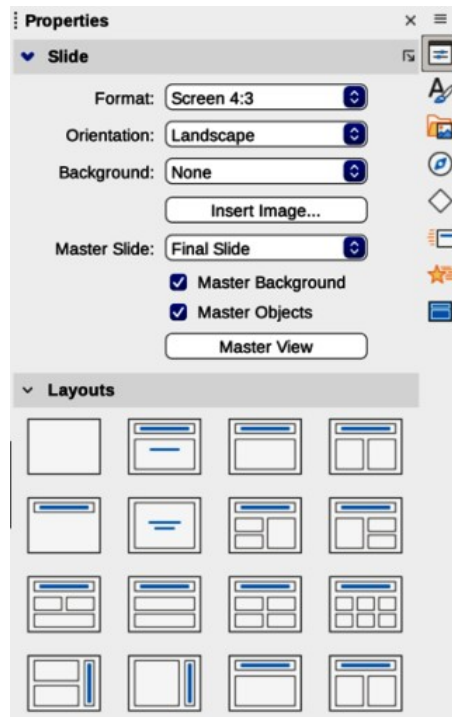

Figure 147: Slide and Layouts panels in Properties deck on Sidebar

The first slide in a presentation is normally a title slide. The layouts *Title Slide*, which also contains a section for a subtitle, or *Title Only* are the most suitable layouts for the first slide in a presentation. For the remaining slides, select the most suitable layout to use for the slide contents.

Impress does not have the functionality to create custom layouts. However, the different elements in a slide layout can be resized and moved. For more information, see the *Impress Guide*.

Selecting slide layout

The available layouts are shown in the **Layouts** panel on the Properties deck on the Sidebar. After selecting a slide, select the slide layout using one of the following methods:

- Go to the Properties deck on the Sidebar to open the **Layouts** panel (Figure 147).
- Click on **Slide Layout** on the Presentation toolbar to open a pop-up **Layouts** panel.
- Click on **Slide > Layout** on the Menu bar to open a drop-down list showing the layouts by name.
- Right-click on the selected slide and select **Layout** in the context menu to open a drop-down list of slide layouts.



Tip

To view the names for slide layouts, use the tooltip feature. Position the cursor on an icon in the **Layouts** panel (or on any other tool icon) in the Properties deck on the Sidebar and its name is displayed in a small rectangle.

Changing slide layout

Change the slide layout for a slide in a presentation as follows:

- 1) Select a slide in the presentation.
- 2) Select a new layout for the slide using one of the methods described in “Selecting slide layout” above.

Slide contents

Several layouts can contain one or more content boxes, as shown by the example in Figure 148. Each of these content boxes can be configured to contain the following elements. For more information on layout content boxes, see the *Impress Guide*.



Figure 148: Example slide using content boxes

Slide title

Click on *Click to add Title* and type a title in the text box. Impress enters text editing mode and the Text Formatting toolbar automatically opens.

Text

Click on *Click to add Text* and type the contents into the text box. Impress enters text editing mode and the Text Formatting toolbar automatically opens.

Table

Go to **Insert > Table** on the Menu bar and the Insert Table dialog opens. Enter the number of columns and rows, then click **OK**. The dialog closes and a table is inserted into the slide. Impress enters text editing mode and the Text Formatting and Table toolbars automatically open.

Chart

Go to **Insert > Chart** on the Menu bar and the Impress default chart is inserted in the slide. The **Chart Type** panel opens in the Properties deck on the Sidebar allowing editing of the chart.

Image

Go to **Insert > Image** on the Menu bar and a file browser opens. Navigate to where the required image is located. Select the file and click on **Open**. The image is placed into the slide and the file browser closes. The **Image** panel opens in the Properties deck on the Sidebar allowing editing of the image file.

Audio or video

Go to **Insert > Audio or Video** on the Menu bar and a file browser opens. Navigate to where the required audio or video file is located. Select the file and click on **Open**. The

audio or video file is inserted into the slide and the file browser closes. The Media Playback toolbar opens allowing operation of the audio or video file.

Note

Text and graphic elements can be readjusted at any time during the preparation of a presentation. However, changing slide layout that already has contents can have a dramatic effect. If the layout is changed after contents have been added, the contents are not lost, but they may need to be reformatted.

Modifying slide elements

When a slide is inserted into a presentation, it contains elements that were included in the selected slide layout. However, it is unlikely that the predefined layouts suit all requirements for a presentation. Elements required maybe removed, or objects inserted such as text and/or graphics.

Although Impress does not have the functionality to create new layouts, it allows for the resizing and moving of the slide elements. It is also possible to add slide elements without being limited to the size and position of content boxes.

Note

It is recommended that changes to slide elements in the layouts included in Impress are only made using **Normal** view, which is the default. Attempting any changes to a slide element when in **Master** view is possible, but may produce unpredictable results. Using **Master** view requires extra care as well as a certain amount of trial and error.

Moving contents box

- 1) Click on the outer frame of the contents box so that the selection handles are displayed.
- 2) Place the cursor on the frame so that it changes shape. This is normally a clenched hand, but depends on the computer setup.
- 3) Click and drag the contents box to its new position on the slide and release.

Resizing contents box

- 1) Click on the outer frame of the contents box so that the selection handles are displayed.
- 2) Place the cursor on the frame so that it changes shape.
- 3) Click and drag the selection handle on the frame to resize the contents box and release.
 - Top and bottom selection handles change the height of a contents box.
 - Left and right selection handles change the width of a contents box.
 - Corner selection handles change width and height of a contents box.

Removing elements

- 1) Select a contents box, or an element to highlight it and the selection handles are displayed.
- 2) Press the *Delete* or *Backspace* key to remove the contents box or element.

Adding text

There are two ways of adding text to a slide — contents box or text box. For more information, see “Adding and formatting text” on page 244 and the *Impress Guide*.

Contents box

Click on *Click to add Text* in the contents box and type the text. Outline styles are automatically applied to the text as it is inserted. If required, change the outline level of each paragraph as well as its position within the contents box by using the arrow buttons on the Outline toolbar and Workspace **Outline** view.

Text box

Click on **Insert Text Box** on the Standard toolbar or Drawing toolbar to select text mode, then click on the slide. A text box is created and the Text Formatting toolbar automatically opens. Type the text and click outside the text box to end text mode.

Adding images or objects

To add images or objects to a slide, for example a picture, clip art, drawing, photograph, or spreadsheet, click on **Insert** on the Menu bar and select in the drop-down menu the image or object type required. See “Inserting images, tables, charts, or media” on page 253 and the *Impress Guide*.

Modifying slide appearance

To change the background and other characteristics of all slides in the presentation, the master slide has to be modified or a different master slide selected, as explained in “Working with master slides” on page 258.

A master slide has a specified set of characteristics that acts as a template and is used as the starting point for creating other slides. These characteristics include slide background, objects in the background, formatting of any text used, and any background graphics.

Impress has a range of master slides, which are found in the Master Slides deck on the Sidebar. Additional master slides can be created or saved, or added from other sources. For more information on inserting, formatting, and changing a background, see the *Impress Guide*, or *Draw Guide*.

For example, to change the background of an individual slide or a master slide:

- 1) Right click on a slide, or master slide, and select **Slide Properties** from the context menu to open the Slide Properties dialog (Figure 149).
- 2) Select the **Background** tab and then select the type of background to use from *None*, *Color*, *Gradient*, *Image*, *Pattern* and *Hatch*.
- 3) Make a selection from the various properties that are available for each type of background.
- 4) Click **OK** to save the change and close the dialog.

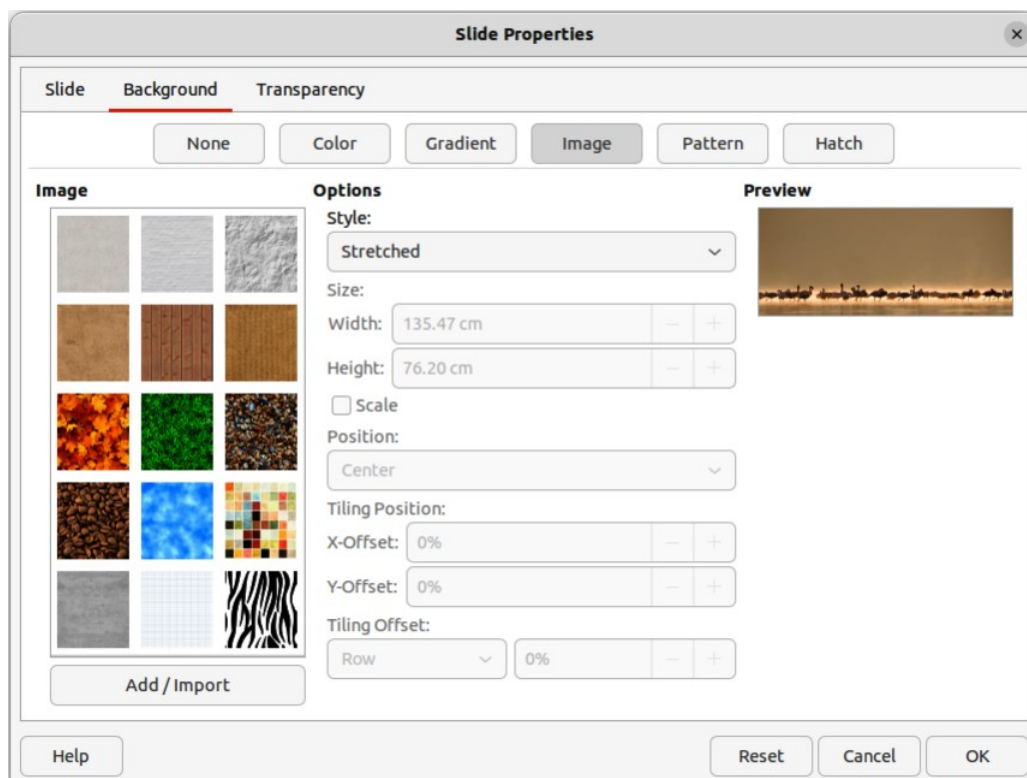

Figure 149: Slide Properties dialog — Background page

Modifying presentations

By default, a presentation displays all the slides in the same order as they appear in **Slide Sorter** view on the Workspace. Run the presentation at least once, then answer the following questions:

- Are the slides in the correct order? If not, some of the slides have to be moved.
- Is the information well spaced and visible to members of an audience at the back of a large room? The audience may not be able to see information at the bottom of a slide, so redesign the presentation to fit the top three-quarters of a screen.
- Would an additional slide make a particular point clearer? If so, create another slide.
- Are some of the slides unnecessary? Hide or delete the slides not required.
- Would animations help some of the slides? This is an advanced technique, but remember that too many animations may not create a good presentation.
- Is the slide transition the same for all sides? Varying transitions can improve a presentation.

Once the questions have been answered, make the necessary changes. Making changes can be carried out in **Slide Sorter** view on the Workspace. For more information on modifying and running a presentation, see the *Impress Guide*.

Adding and formatting text

Most of the slides in a presentation are likely to contain some text. This section gives some guidelines on how to add text and change its appearance. Text used in slides is contained in text boxes. For more information on adding and formatting text, see the *Impress Guide*.

Two types of text boxes (AutoLayout text box and text box) are available in Impress for use on slides. Both types of text boxes can be moved, resized, and deleted.

- Choose a predefined layout from the **Layouts** panel on the Properties deck on the Sidebar and do not select any special content type. These text boxes are called AutoLayout text boxes.
- Use **Insert Text Box** for horizontal text, or **Insert Vertical Text** for vertical text on the Standard toolbar, Drawing toolbar, or Text toolbar (Figure 150) to create text boxes on a slide.
- Use the keyboard shortcut *F2* to create text boxes on a slide for horizontal text.



Figure 150: Text toolbar

When adding and formatting text, the Text Formatting toolbar (Figure 151) normally opens, automatically providing a range of tools to add and format text.

Note

If the toolbars are not visible, go to **View > Toolbars** on the Menu bar and select the required toolbars in the drop-down list.

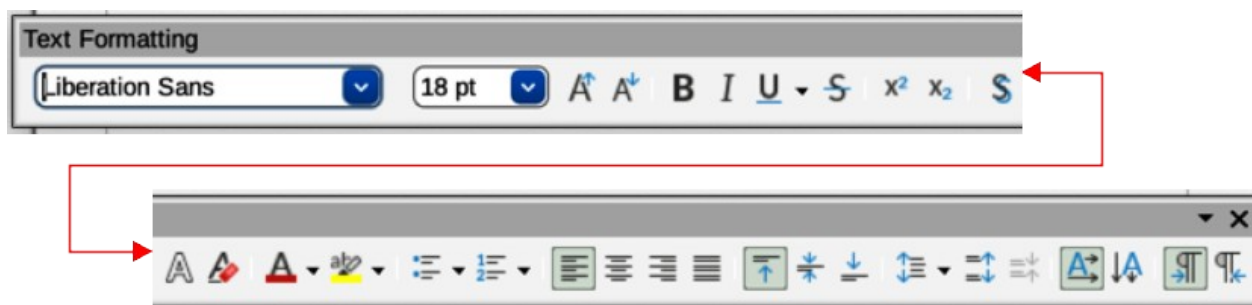

Figure 151: Text Formatting toolbar

Note

The area fill and borders in AutoLayout text boxes and text boxes can be edited using the same methods that are used for graphic objects. For more information, see the *Impress Guide*.

AutoLayout text boxes

AutoLayout text boxes are automatically created when one of the slide layouts available in Impress is selected.

- 1) Make sure **Normal** view is selected in the Workspace.
- 2) Select the slide where text is to be added into an AutoLayout text box.
- 3) Click on *Click to add Title* or *Click to add text* in an AutoLayout text box. The text automatically disappears and is replaced by a flashing text cursor. The Text Formatting toolbar automatically opens replacing the Line and Filling toolbar.
- 4) Type or paste text into the AutoLayout text box and, if necessary, format the text to the presentation requirements.

5) Click outside the AutoLayout text box to deselect it.

Text boxes

- 1) Make sure **Normal** view is selected in the Workspace.
- 2) Select the slide where the text is to be added.
- 3) For horizontal text: click on the selected slide and create a text box using one of the following methods:
 - Single line text box — select **Insert Text Box**, click on the slide and then type or paste the text. The width of the text box increases as text is added creating a single line of horizontal text.
 - Single line text box — use the keyboard shortcut *F2*, click on the slide and then type or paste the text. The width of the text box increases as text is added creating a single line of horizontal text.
 - Multiple line text box — select **Insert Text Box**, or use the keyboard shortcut *F2*, click on the slide and drag to the approximate width required for the text box, then type or paste the text into the text box. The width of the text box is fixed and the height of the text box increases automatically as text is added creating multiple lines of horizontal text.
 - Multiple line text box from a single line text box — use the *Enter* key to create a new paragraph, or the keyboard combination *Shift+Enter* to create a line break in the text.
- 4) Select the text box to switch on edit mode. This is indicated by a colored border as shown in by the example in Figure 152. The width and final position of the text box can be adjusted after adding text into the text box.
- 5) Click outside the text box to deselect it.

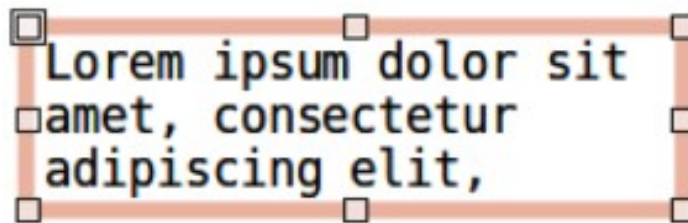

Figure 152: Example of a text box in edit mode

Vertical text

In addition to normal text boxes, where text is horizontally aligned, it is possible to insert text boxes where the text is vertically aligned. Vertical text is available only when Asian languages are selected in **Tools > Options > Language Settings > Languages** (macOS **LibreOffice > Preferences > Language Settings > Languages**).

Creating vertical text boxes is similar to creating horizontal text boxes. Use the **Insert Vertical Text** tool on the Standard, Drawing, or Text toolbars to create a vertical text box with single or multiple lines of text. See “Text boxes” on page 246 on how to create a text box for single or multiple lines of text.

Quick font resizing

To quickly increase or decrease the font size of selected text by using the tools **Increase Font Size** (*Ctrl+]*) (macOS *⌘+]*) and **Decrease Font Size** (*Ctrl+[*) (macOS *⌘+[*) on the Text

Formatting toolbar. The amount by which the font size changes depends on the standard sizes available for the font in use.

Note

AutoLayout text boxes automatically adjust font size of any text inserted into the box. For example, if a long piece of text is inserted into an AutoLayout text box, the font size may decrease in size to fit into the box.

Pasting text

Text can be added to an AutoLayout, or normal text box, by copying it from another document and pasting it into Impress. The formatting of pasted text will probably not match the formatting of the surrounding text, or that of the other slides in the presentation. This maybe what is required on some occasions. However, to make sure that the presentation style is consistent and does not become a patchwork of different styles, font types, bullet points, and so on, the text has to be formatted to match the rest of the presentation.

Unformatted text

It is good practice to paste text without formatting and apply the formatting later.

- 1) Highlight and copy the text from another document or slide.
- 2) Create a text box on a slide and make sure the text cursor is flashing in the text box. Alternatively, select an AutoLayout text box on a slide. See “Text boxes” on page 246 and see “AutoLayout text boxes” on page 245 and the *Impress Guide* for more information.
- 3) Paste unformatted text into the text box using one of the following methods. Text is pasted at the cursor position in the text box formatted using the Default Drawing Style, or Presentation Style if text was pasted into an AutoLayout text box.
 - Go to **Edit > Paste Special > Paste Unformatted Text** on the Menu bar.
 - Click on the triangle ▼ to the right of the **Paste** tool on the Standard toolbar and select **Unformatted Text** in the context menu.
 - Use the keyboard shortcut *Ctrl+Shift+V* (macOS +*Shift+V*) and select **Unformatted text** on the dialog that opens.
- 4) Format the text to the presentation requirements using the tools on the Text Formatting toolbar, or the options in **Format** on the Menu bar.

Note

The Presentation style used in AutoLayout text boxes cannot be changed by selecting another presentation style. Make sure the AutoLayout text box uses the presentation style required. Change outline levels and outline styles using the *Tab* key or *Shift+Tab* key combination. See the *Impress Guide* for more information.

AutoLayout text box formatting of pasted text

If text is being pasted into an AutoLayout text box, the appropriate outline style has to be applied to the text giving it the same look and feel as the rest of the presentation.

- 1) Highlight and copy the text from another document or slide.
- 2) Paste the text into the AutoLayout text box, then select the pasted text.

- 3) Select **Format > Clear Direct Formatting** on the Menu bar, or use the keyboard shortcut *Ctrl+Shift+M* (macOS *⌘+Shift+M*) to make sure any formatting is removed from the pasted text.
- 4) Use the four arrow buttons on the Outline toolbar to move the text to the appropriate position and give it the appropriate outline level.
 - Left arrow promotes a list entry by one level (for example from Outline 3 to Outline 2). Alternatively, place the cursor at the beginning of the paragraph and use the *Shift+Tab* keys.
 - Right arrow demotes a list entry by one level. Alternatively, place the cursor at the beginning of the paragraph and use the *Tab* key.
 - Up arrow moves a list entry up in the list order.
 - Down arrow moves a list entry down in the list order.
- 5) If necessary, modify the presentation style to format the text to the presentation requirements to change font attributes, tabs, and so on. See the *Impress Guide* for more information. Alternatively, apply any necessary manual or direct formatting to the text.

Text box formatting of pasted text

Pasting formatted text into a text box overwrites any formatting and replaces the text box style.

- 1) Highlight and copy the text from another document or slide.
- 2) If necessary, create a text box on a slide and make sure the text cursor is flashing in the text box. See “Text boxes” on page 246 and the *Impress Guide* for more information.
- 3) Paste formatted text into the text box. Text is pasted at the cursor position in the text box and the text formatting of the pasted text overwrites any style formatting of the text box.
- 4) Select **Format > Clear Direct Formatting** on the Menu bar or use the keyboard shortcut *Ctrl+Shift+M* (macOS *⌘+Shift+M*) to make sure any formatting is removed from the pasted text.
- 5) Select the required drawing style to format the text from the available drawing styles.
- 6) If necessary, modify a drawing style or create a new drawing style to format the text to the presentation requirements. See the *Impress Guide* for more information.

Note



Drawing styles can be created in Impress and are only available for the presentation which is being created and has been saved. Templates can also be created that include any drawing styles required. For more information, see the *Impress Guide*.

Creating lists

The procedure to create an unordered (bulleted) or ordered (numbered) list varies depending on the type of text box used. The tools to manage and format a list are the same. To change the appearance of a list, see “Changing list type” on page 250.

AutoLayout text boxes

In AutoLayout text boxes and by default, the outline styles available are unordered lists. An example of these outline styles is shown in Figure 153. These outline styles are presentation styles and cannot be deleted, but can be modified or updated to the presentation requirements. See the *Impress Guide* for more information.

- Use the keyboard shortcut *Alt+Shift+Left Arrow* (macOS +*Shift+Left Arrow*)
- 3) To move a list point lower in the list order without changing the outline level, use one of the following methods:
 - Click on **Move Down** to move selected paragraphs down one paragraph on the Outline toolbar, or the **Lists** panel on the Properties deck in the Sidebar.
 - Go to **Format > Lists** on the Menu bar and select **Move Down** in the submenu.
 - Use the keyboard shortcut *Alt+Shift+Down Arrow* (macOS +*Shift+Down Arrow*).
 - 4) To move a list point higher in the list order without changing the outline level, use one of the following methods:
 - Click on **Move Up** to move selected paragraphs up one paragraph on the Outline toolbar, or the **Lists** panel on the Properties deck in the Sidebar.
 - Go to **Format > Lists** on the Menu bar and select **Move Up** in the submenu.
 - Use the keyboard shortcut *Alt+Shift+Up Arrow* (macOS +*Shift+Up Arrow*).

Note

In AutoLayout text boxes, promoting or demoting an item in the list corresponds to applying a different outline style. The second outline level corresponds to Outline 2 style, the third outline level to Outline 3 style, and so on. A change in level and style produces other changes, for example, to font size, bullet type, and so on.

Text boxes

Create an unordered or ordered list in a text box as follows:

- 1) Create a text box on a slide and make sure the cursor is flashing in the text box. See “Text boxes” on page 246 on how to create a text box.
- 2) Create a list using one of the following methods:
 - Click on **Toggle Unordered List** or **Toggle Ordered List** on the Text Formatting toolbar.
 - Click on **Toggle Unordered List** or **Toggle Ordered List** in the **Lists** panel on the Properties deck in the Sidebar.
 - Go to **Format > Lists** on the Menu bar and select **Unordered List** or **Ordered List** in the submenu.
- 3) Type the text and press *Enter* to start a new list point or use the keyboard combination *Shift+Enter* to start a new line without creating a new list point. The new line will have the same indentation as the list point.
- 4) To increase or decrease the indent level of a list point, or move a list point up or down, see “Changing outline level” on page 249.

Changing list type

The list type can be changed for an unordered or ordered type for the entire list or for a single point only as follows:

- 1) Select a point in a list, or select the entire list in the text box. Alternatively, click on the border of the text box so that the resizing handles are displayed to select the entire list.

- 2) Change the list type from unordered to ordered list, or ordered to unordered as described in “Text boxes” above.
- 3) If required, change the type of bullet or number used for the list:
 - a) Click on the triangle ▼ to the right of the **Toggle Unordered List**, or **Toggle Ordered List**, on the Text Formatting toolbar, or the **Lists** panel on the Properties deck in the Sidebar.
 - b) Select a bullet or number type from the options available in the drop-down window as shown in Figure 154, or Figure 155.
 - c) If necessary, click on **More Bullets**, or **More Numbering**, in the drop-down window to open the Bullets and Numbering dialog for further options to change the list appearance. See the *Impress Guide* for more information.

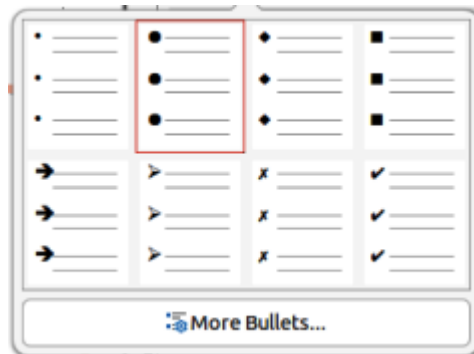

Figure 154: More Bullets dialog

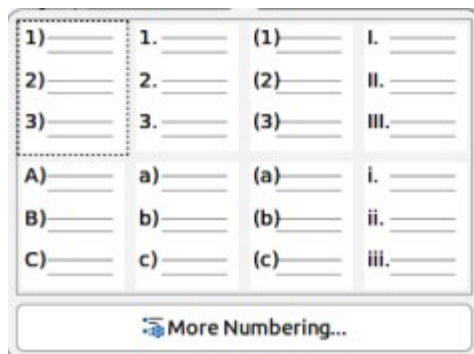

Figure 155: More Numbering dialog

Changing bullet or number format

The bullet, or number format used in a list can be changed for the entire list, or for a single point only as follows:

- 1) Select a point in a list, or select the entire list in the text box. Alternatively, click on the border of the text box so that the resizing handles are displayed to select the entire list.
- 2) Click on the triangle ▼ to the right of the **Toggle Unordered List**, or **Toggle Ordered List**, on the Text Formatting toolbar, or the **Lists** panel on the Properties deck in the Sidebar to open a drop-down dialog displaying the format options available.
- 3) Select a bullet or number type from the options available in the drop-down window as shown in Figure 154, or Figure 155.
- 4) If necessary, click on **More Bullets**, or **More Numbering**, in the drop-down window to open the Bullets and Numbering dialog for further options to change the list appearance. See the *Impress Guide* for more information.

Notes

The Bullets and Numbering dialog can also be opened by going to **Format > Bullets and Numbering** on the Menu bar, or by right-clicking on a list point and selecting **Bullets and Numbering** from the context menu.

If a list was created in an AutoLayout text box, then the Outline styles can be modified to change the list type and/or format. Changes made to an Outline style apply to all the slides that use that style. See the *Impress Guide* for more information.

Text in a presentation can be formatted into columns inside text boxes and objects. However, columns cannot be used on separate parts of text inside a text box or object. The whole of the text box or object has to be used for columns.

Text columns

The type of columns used in Impress are continuous flow columns. This means that when text reaches the bottom of a column, it automatically flows into the next column as text is added. This type of columns is also known as newspaper columns.

Note

Any text inside a text box, or graphic object, automatically flows into column format when the changes are saved.

- 1) Columns in text boxes and graphic objects are created as follows:
 - For text boxes — click the border of a text box to select it so that the selection handles are displayed indicating that the text box is in edit mode.
 - For graphic objects — double-click on a graphic object to select it so that the selection handles are displayed and the cursor flashes in the center of the object indicating that the object is in text edit mode.
- 2) Open the options for text columns using one of the following methods:
 - Right-click in the text box or graphic object and select **Text Attributes** in the context menu to open the Text dialog, then click on the **Text Columns** tab to open the **Text Columns** page (Figure 156),
 - Click on **Columns** in Properties on the Sidebar to open the **Columns** panel (Figure 157).
- 3) Set the number of columns required in the *Number of columns* box and the required spacing between the columns in the *Spacing* box.
- 4) Save the changes and deselect the text box, or graphic object, using one of the following methods:
 - For the Text dialog, click **OK** to save the changes and close the dialog, then click outside the text box, or graphic object, to deselect it.
 - For the **Columns** panel in the Properties deck on the Sidebar, click outside the text box, or graphic object, to deselect it and save the changes.
- 5) Type in the required text or use copy and paste to enter the required text into the text box, or graphic object. Any text entered will be in column format.
- 6) If necessary, format the text to the presentation requirements.
- 7) Click outside the text box, or graphic object, to deselect it and save the changes.

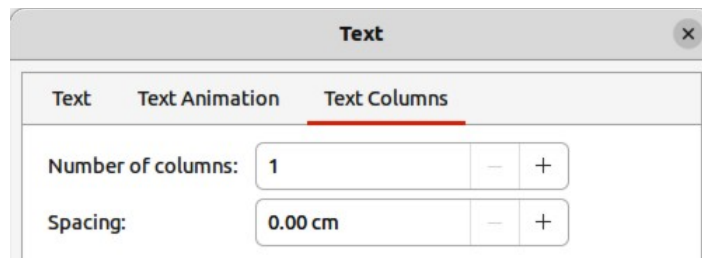

Figure 156: Text dialog — Text Columns page

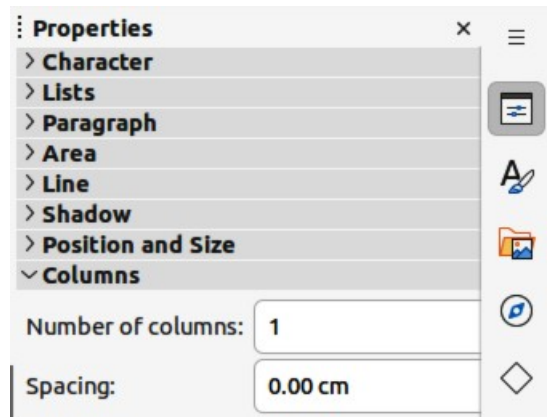

Figure 157: Columns panel in Properties deck on Sidebar

Inserting images, tables, charts, or media

A contents box on a slide can contain images, tables, charts, or media as well as text. The Insert toolbar (Figure 158) provides quick access to relevant tools. This section provides an overview of how to work with these objects. For more information, see the *Impress Guide*.

Inserting images

- 1) Open the slide in **Normal** view on the Workspace where the image is going to be inserted.
- 2) Open the Insert Image file browser using one of the following methods:
 - Go to **Insert > Image** on the Menu bar.
 - Click on **Insert Image** on the Insert toolbar (Figure 158).
 - Click on **Insert Image** on the Standard toolbar.
- 3) Navigate to the location of the file and select the image file required.
- 4) Click **Open** to place the image in the center of the slide.
- 5) Reposition and resize the image to the presentation requirements.

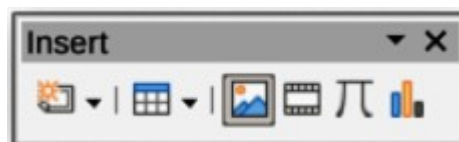

Figure 158: Insert toolbar

Using Insert or Standard toolbar

- 1) Open the slide in **Normal** view on the Workspace and click on **Table** on the Insert toolbar or the Standard toolbar to open the Insert Table Grid (Figure 161).

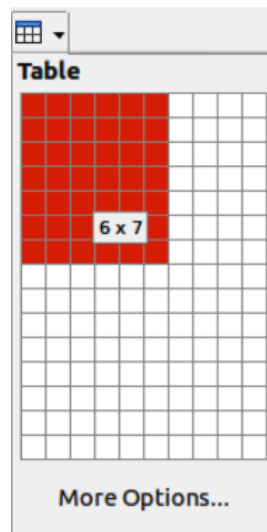

Figure 161: Insert Table graphic

- 2) Click and drag the cursor to create the number of columns and rows required, then click to place the table in the center of the slide and the Insert Table Grid closes.
- 3) The **Table Design** panel on the Properties deck in the Sidebar opens (Figure 162). Select a table design, the type of rows, and the type of columns from the options available.
- 4) If necessary, reposition and format the table on the slide to the presentation requirements.

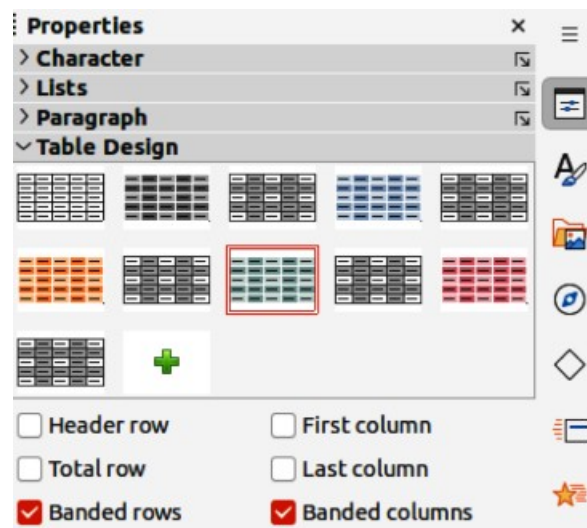

Figure 162: Table Design panel in Properties deck on Sidebar

Note

Select *More Options* at the bottom of the Insert Table grid (Figure 161) to open the Insert Table dialog (Figure 160) where the number of rows and columns required can be selected.

Inserting charts

To insert a chart into a selected slide in **Normal** view on the Workspace, use one of the following methods:

- Go to **Insert > Chart** on the Menu bar.
- Click on **Insert Chart** on the Insert toolbar.

When Impress switches to chart view, the Formatting toolbar (Figure 163) automatically opens, and the **Chart Type** panel on the Properties deck on the Sidebar opens (Figure 164). To change the chart type, insert the required data, and change the formatting, see the *Impress Guide* and the *Calc Guide*.



Figure 163: Formatting toolbar

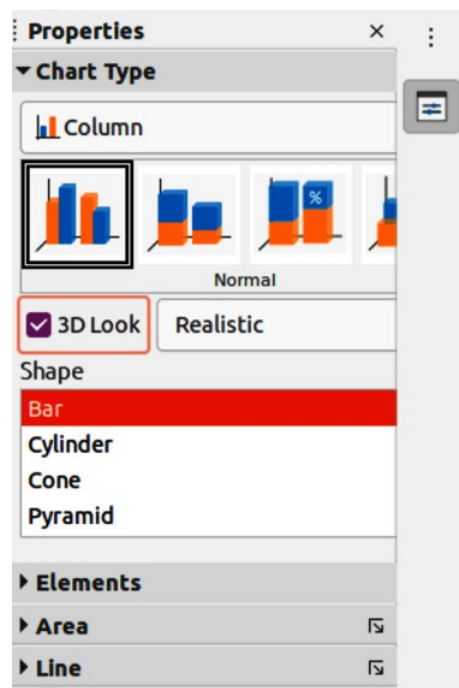

Figure 164: Chart Type panel in Properties deck on Sidebar

Inserting audio or video

Using a file browser

- 1) Go to **Insert > Audio or Video** on the Menu bar, or click on **Insert Audio or Video** on the Insert toolbar and the Insert Audio or Video file browser opens.
- 2) Navigate to the folder where the file is located and select the audio or video file you want to insert onto a slide. Only the audio and video files that are compatible with Impress will be highlighted in the file browser.
- 3) Click **Open** to place the audio or video file in the center of the slide. The **Media Playback** toolbar opens while the audio or video file is selected.
- 4) Reposition and/or resize the audio or video file. See the *Impress Guide* for more information.

Using the Gallery

- 1) If the Gallery deck (Figure 165) is not already open, use one of the following methods:
 - Go to **View > Sidebar** on the Menu bar to open the Sidebar, then select **Gallery**.
 - Go to **View > Gallery** on the Menu bar.
- 2) Browse to a category containing media files, for example *Sounds*.
- 3) Click on the audio or video file required and drag it onto the slide. The Media Playback toolbar automatically opens.
- 4) Reposition and/or resize the audio or video file. See the *Impress Guide* for more information.

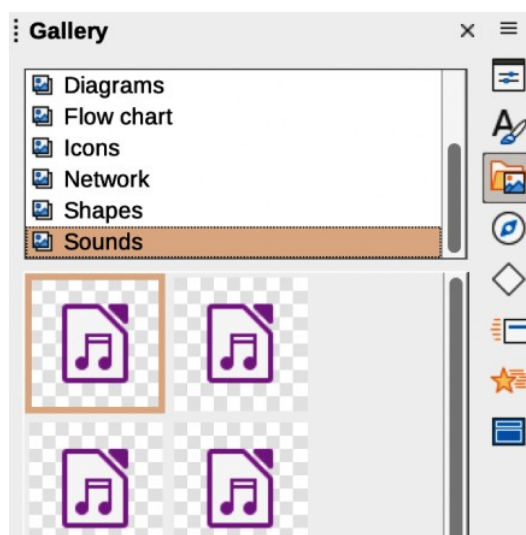

Figure 165: Gallery deck in Sidebar

Inserting graphics, spreadsheets, and OLE objects

Graphics

Graphics, such as shapes, callouts, and arrows, are often useful to complement the text on a slide. These objects are handled much the same way as graphics in Draw. For more information on inserting graphics, see Chapter 7, *Getting Started with Draw* in this guide, the *Impress Guide*, or the *Draw Guide*.

Spreadsheets

Spreadsheets embedded in Impress include most of the functionality of Calc spreadsheets and are capable of performing complex calculations and data analysis. If the data has to be analyzed or formulas applied, then these operations are best performed in a Calc spreadsheet and the results displayed in an embedded Calc spreadsheet or in an Impress table. For more information on spreadsheets, see the *Impress Guide* and the *Calc Guide*.

OLE objects

Object Linking and Embedding (OLE) is a software technology that allows linking and embedding of spreadsheets, charts, drawings, formulas, and text files into an Impress presentation.

The major benefit of using OLE objects is that it provides a quick and easy method of editing the object using tools from the software used to create the object. These file types can all be created using LibreOffice and OLE objects can be created from new or from an existing file.

When inserting a new OLE object into a presentation, it is only available in that presentation and can only be edited using Impress. For more information on inserting and formatting OLE objects, see the *Impress Guide*.

Working with master slides

A master slide is a slide that is used as the starting point for other slides. It is similar to a page style in LibreOffice Writer as it controls the basic formatting of all slides based on it. A presentation can have more than one master slide.

A master slide has a defined set of characteristics, including the background color, graphics, or gradients. It also can include objects (for example, logos, decorative lines) in the background; headers and footers; placement and size of text frames; and text formatting.

Styles

All of the characteristics of master slides are controlled by styles. The styles of any new slide created are inherited from the master slide from which it was created. In other words, the styles of the master slide are available and applied to all slides created from that master slide. Changing a style in a master slide results in changes to all the slides based on that master slide. It is possible to modify each individual slide without affecting the master slide.

Master slides have two types of styles — presentation styles and drawing styles. The presentation styles included with Impress can be modified, but new presentation styles cannot be created or deleted. The drawing styles included with Impress can be modified, but cannot be deleted. However, new drawing styles can be created and these drawing styles can be deleted.

Note

It is highly recommended to use the master slides whenever possible. However, there are occasions where manual changes are needed for a particular slide, for example editing an individual slide to enlarge the chart area when the text and chart layout is used.

Master slides

Impress comes with a collection of master slides, which are shown on the Master Slides deck of the Sidebar (Figure 166).

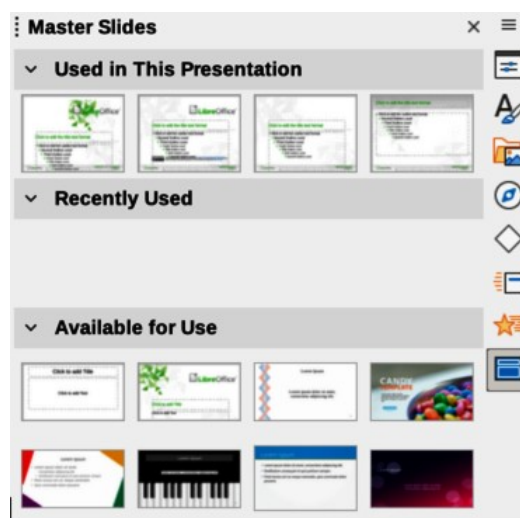

Figure 166: Master Slides deck on Sidebar

This deck has three panels: **Used in This Presentation**, **Recently Used**, and **Available for Use**. Click the expand marker on the title bar of a panel to expand it and show thumbnails of the master slides, or click the collapse marker to collapse the panel to hide the thumbnails.

Each of the master slides shown in the **Available for Use** panel are from templates that are available in LibreOffice Impress:

- Presentation templates included when LibreOffice is installed on a computer.
- Templates have been created, or added from other sources.

If a new presentation is created without using one of the templates available, then a default master slide is available. This default master slide is a good starting point for creating master slides. An example of the default master slide is shown in Figure 167.

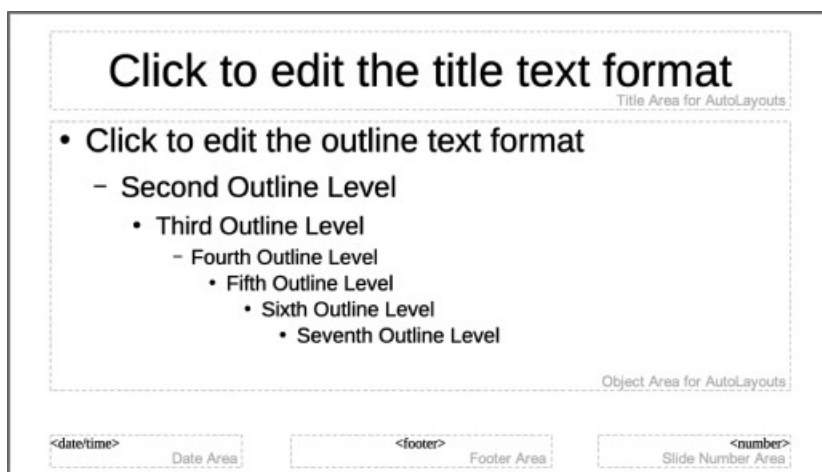

Figure 167: Default Master Slide

Creating master slides

- 1) Go to **View > Master Slide** on the Menu bar to open Master view in the Workspace. The Master View toolbar also opens (Figure 168). If the Master View toolbar does not open, go to **View > Toolbars** on the Menu bar and select **Master View**.

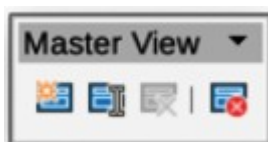

Figure 168: Master View toolbar

- 2) Create a new master slide using one of the following methods and the new master slide appears in the Slides pane:
 - Click on **New Master** in the Master View toolbar.
 - Right-click on a master slide in the **Slides** pane and select **New Master** in the context menu.
 - Go to **Slide > New Master** on the Menu bar.
- 3) Rename the new master slide using one of the following methods to open the Rename Master Slide dialog:
 - Click on **Rename Master** on the Master View toolbar.
 - Right-click on the new master slide in the Slides Pane and select **Rename Master** in the context menu.

- 4) Enter a memorable name for the new master slide in the **Name** text box, then click **OK** to save the changes and close the dialog.
- 5) Make sure the new master slide is selected in the Slides pane and add all the text, graphics and master elements that are required. For more information on adding, editing, formatting and managing the different types of objects on a master slide, see the *Impress Guide*.
- 6) When the new master slide has been created, use one of the following methods to return to **Normal** view:
 - Click **Close Master View** on the Master View toolbar.
 - Go to **View > Normal** on the Menu bar.
- 7) Save the presentation file before continuing.

Applying master slides

To apply a master slide to all slides or selected slides in a presentation:

- 1) Click on **Master Slides** on the right of the Sidebar to open the Master Slides deck (Figure 166 on page 258).
- 2) Right-click on the required master slide in the **Used in This Presentation** panel.
- 3) Select **Apply to All Slides**, or **Apply to Selected Slides** in the context menu.

Loading additional master slides

In a presentation, it maybe necessary to mix multiple master slides that belong to different templates (for more information on templates, see the *Impress Guide*). For example, a completely different layout for the first slide of the presentation maybe required, or a slide from a different presentation maybe added to the current presentation.

- 1) Select the slide or slides on the Slides pane where the master slide is to be changed.
- 2) Go to **Slide > Change Slide Master** on the Menu bar to open the Available Master Slides dialog (Figure 169).

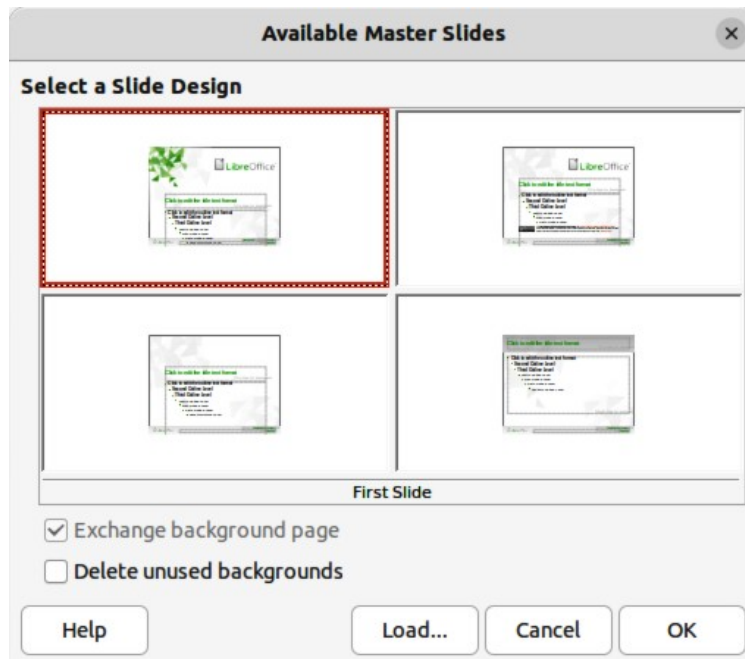

Figure 169: Available Master Slides dialog

- 3) To add master slides, click on **Load** to open the Load Master Slide dialog (Figure 170).
- 4) In the Load Master Slide dialog, select the template category and the template to load as the master slide

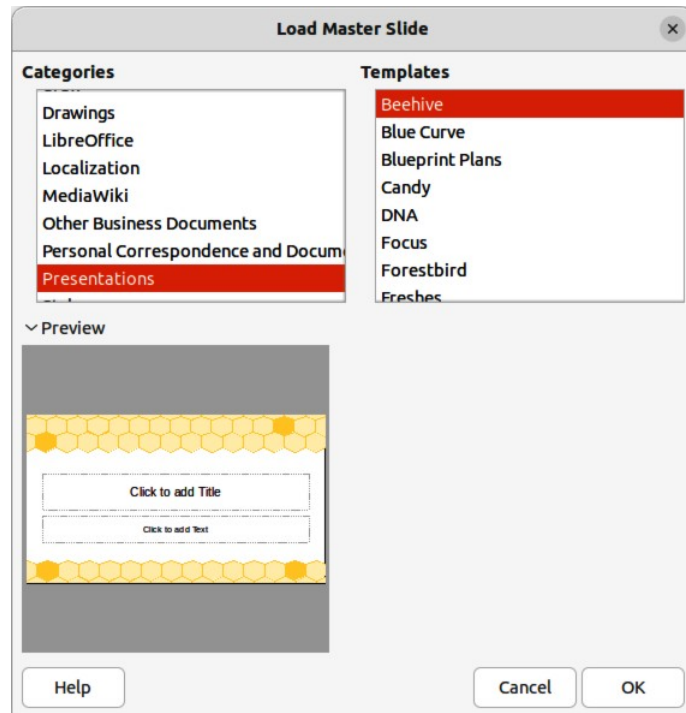

Figure 170: Load Master Slide dialog

- 5) Click **OK** to close the Load Master Slide dialog and the master slides from the selected template appear in the Available Master Slides dialog.
- 6) In the Available Master Slides dialog, select the master slide required in the *Select a Slide Design* box.
- 7) To apply the selected master slide to all slides in the presentation, select the *Exchange background page* check box. To apply the slide design to the selected slides only, deselect the *Exchange background page* check box.
- 8) Click **OK** to apply the selection to the slides and close the dialog.

Note

The master slides in the template selected are now shown in the *Available for use* panel on the Master Slides deck on the Sidebar.

Modifying master slides

The following items can be changed on a master slide. For more information, see the *Impress Guide*:

- Background (color, gradient, hatching, or bitmap).
- Background objects (for example, adding a logo or decorative graphics).
- Text attributes for the main text area and notes.
- Size, placement, and contents of header and footer elements to appear on every slide.
- Size and placement of default frames for slide titles and content.

To modify a master slide as follows:

- 1) Select **View > Master Slide** on the Menu bar. This also opens the Master View toolbar.
- 2) Select a master slide for editing in the Slides pane so that it appears in the Workspace.
- 3) Go to **Slide > Slide Properties** on the Menu bar or right-click in the Workspace and select **Slide Properties** in the context menu to open the Slide Properties dialog (Figure 171).
- 4) Use the various options in the **Slide**, **Background**, and **Transparency** pages in the Slide Properties dialog to make changes to the format of the master slide.
- 5) Click **OK** to save the changes and close the Slide Properties dialog.
- 6) Select an object on the master slide, then right-click on the object to open a context menu.
- 7) Select one of the options in the context menu to edit the object. Selecting an option may open another context menu, a dialog, an application or file browser window to make the necessary changes to the selected object.
- 8) Click **Close Master View** on the Master View toolbar or go to **View > Normal** on the Menu bar to exit from editing master slides.
- 9) Save the presentation file before continuing.

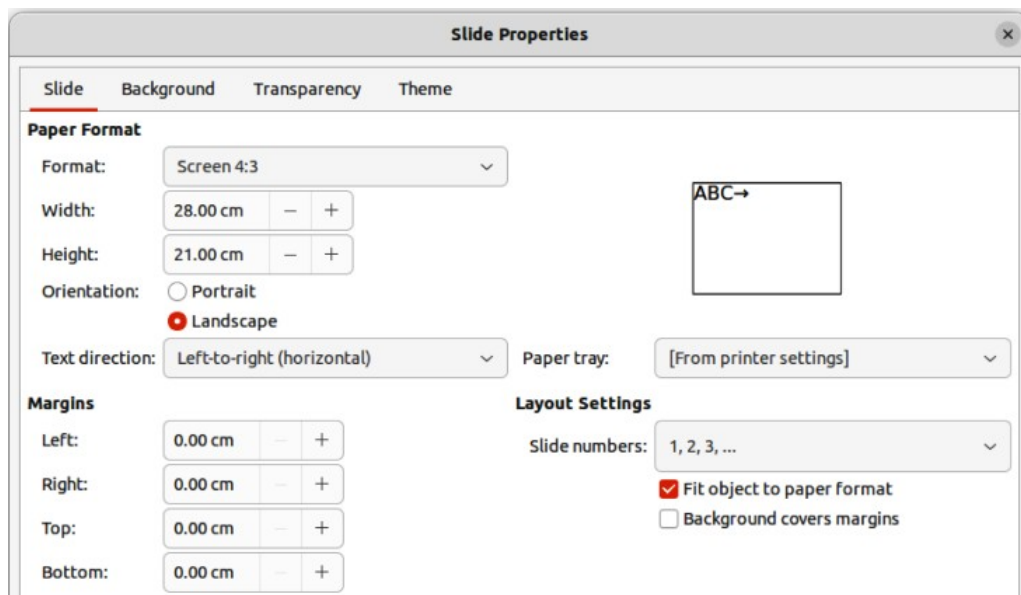

Figure 171: Slide Properties dialog

Notes

Any changes made to one slide when in Master Slide mode appears on all slides using this master slide. Always make sure to close **Master Slide** and return to **Normal** view before working on any of the presentation slides.

The changes made to an element on a slide in **Normal** view is not overridden by subsequent changes to the master slide. However, sometimes it is desirable to change a manually modified element of a slide to the style defined in the master slide. To change to default formatting, select the element and select **Format > Clear Direct Formatting** on the Menu bar.

Adding text, footers, and fields to master slides

Text, footers, or fields can be added to a master slide so these elements appear on every slide in a presentation. Headers are not normally added to slides.

Text

- 1) Go to **View > Master Slide** on the Menu bar to open **Master View**.
- 2) Insert a text box on the master slide, see “Text boxes” on page 246 for more information.
- 3) Type or paste the text into the text box.
- 4) Click outside the text box when finished adding text.
- 5) Go to **View > Normal** on the Menu bar or click **Close Master View** on the Master View toolbar when finished.

Default footers

By default, a slide footer consists of three sections, each containing a default field:

- Left section — date and time, labeled *Date Area*. Field name is `<date/time>`.
- Center section — footer text, labeled *Footer Area*. Field name is `<footer>`. This section could be the presentation title, file name, or other information.
- Right section — slide number, labeled *Slide Number Area*. Field name is `<number>`.

The default footer fields are set up as follows using the Header and Footer dialog (Figure 172):

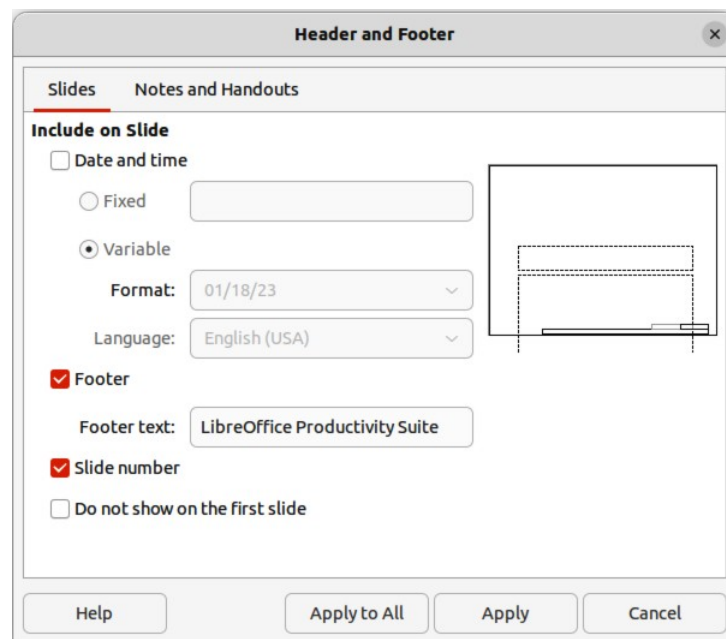

Figure 172: Header and Footer dialog — Slides page

- 1) Go to **View > Master Slide** on the Menu bar to open Master View.
- 2) Go to **Insert > Header and Footer** on the Menu bar to open the Header and Footer dialog.
- 3) Click on the **Slides** tab to open the options available for inserting footers onto a slide.
- 4) Select *Date and Time* for the date and time to appear in the left section of the footer.
 - For a fixed date and time, select *Fixed* and enter the date required in the *Fixed* text box.

- For a variable date and time, select *Variable*, then select the format and language in the *Format* and *Language* drop-down lists. Using a variable date and time means that each time the presentation is opened, the date and time are updated.
- 5) To place text in the footer center section, select *Footer* and then type or paste the text into the *Footer text* input field.
- 6) To place the slide number in the right section of the footer, select *Slide number*.
- 7) If the footer is not going to appear on the first slide of a presentation, select *Do not show on the first slide*. The first slide is normally the title slide of a presentation.
- 8) Click **Apply** to save the changes and close the Header and Footer dialog.
- 9) To format the text used for the default footer fields, see the *Impress Guide*.
- 10) Click **Close Master View** on the Master View toolbar, or go to **View > Normal** on the Menu bar when setting up the default footer fields is completed.

Note

The default sections in a footer can be formatted, resized, and repositioned. See “Adding and formatting text” on page 244 for more information.

Custom footers

The default fields in a footer section can be replaced with text, or manual fields as follows:

- 1) Go to **View > Master Slide** on the Menu bar to open the master slide view.
- 2) Highlight the default field in the footer section and press the *Delete* or *Backspace* key. A flashing text cursor will appear in the footer section and the Text Formatting toolbar automatically opens replacing the Line and Filling toolbar.
- 3) Type in the required text or insert a manual field into the footer section. For more information, see “Manual fields” on page 264.
- 4) Format the text or manual field placed in the footer section. See “Adding and formatting text” on page 244 and the *Impress Guide* for more information.
- 5) Click outside the footer section to close the Text Formatting toolbar and reopen the Line and Filling toolbar.
- 6) Click **Close Master View** on the Master View toolbar or go to **View > Normal** on the Menu bar when setting up a custom footer section is completed.

Manual fields

Manual fields can be added as text objects on a master slide or replace one of the default footer fields and are as follows:

- Date (fixed)
- Date (variable) — updates automatically each time the presentation is opened.
- Time (fixed)
- Time (variable) — updates automatically each time the presentation is opened and each time a slide is opened more than once during a presentation.
- Author — first and last names listed in the LibreOffice user data.
- Slide number — the sequence number of the slide, without the word “Slide”.
- Slide Title — defaults to Slide 1, Slide 2, and so on if the slides have not been renamed.

- Slide Count — the number of slides in the presentation.
- File Name

Adding comments

Impress supports comments similar to those in Writer and Calc. For more about adding, navigating, and replying to comments, see Chapter 2, Getting Started with Writer.

Before using comments, make sure that the user name and initials are entered into **Tools > Options > LibreOffice > User Data** (macOS **LibreOffice > Preferences > LibreOffice > User Data**). The name and initials then appear in the comment marker and in the Author field of the comment. If more than one person edits the document, each person is automatically allocated a different background color.

- 1) In **Normal View**, go to **Insert > Comment** on the Menu bar or use the keyboard shortcut *Ctrl+Alt+C* to open a blank comment (Figure 173).
- 2) Move the small comment markers to the required position on the slide. Normally, this is on or near the text or object being referred to in the comment.
- 3) To show or hide the comment markers, choose **View > Comments** on the Menu bar.
- 4) Select **Tools > Options > LibreOffice > User Data** to configure the name and initials that appear in comments.

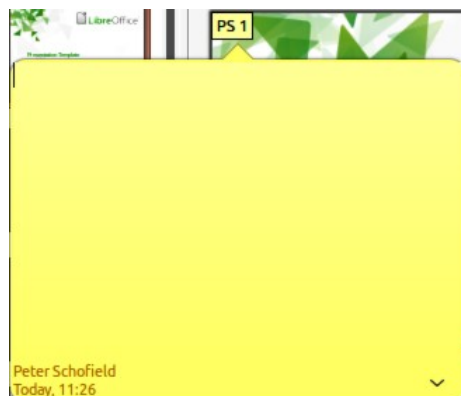

Figure 173: Adding a comment

Note

A small box containing the user initials appears in the upper left-hand corner of the slide, with a larger text box beside it. Impress automatically adds the user name and current date at the bottom of the text box.

Printing handouts

Handouts are used for distributing copies of presentation slides to each member of the audience. Handouts are only available in **View > Handout** on the Menu bar and are printed using the printing options in Impress.

The printing of handouts depends on the printer, computer operating system, and how a computer is set up. The following is only an example of how to print handouts.

- 1) Go to **View > Master Handout** on the Menu bar to open the Master Handout layout in the Workspace. An example Master Handout is shown in Figure 174.

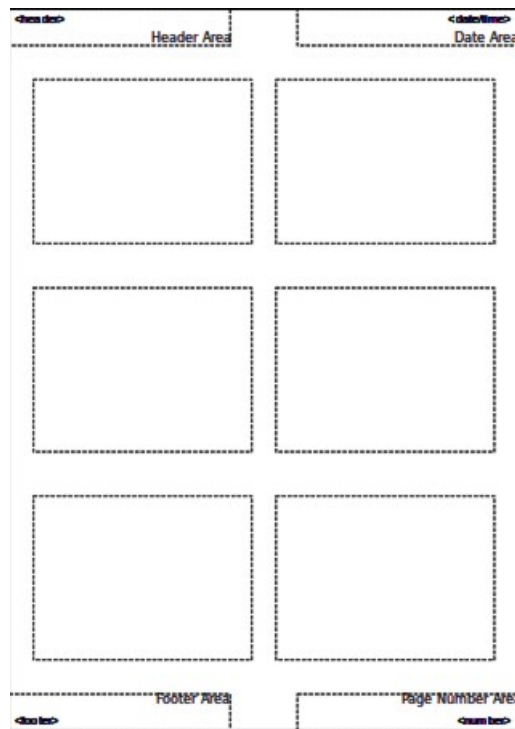

Figure 174: Example of Master Handout layout

2) Go to **Insert > Header and Footer** on the Menu bar to open the Header and Footer dialog (Figure 175).

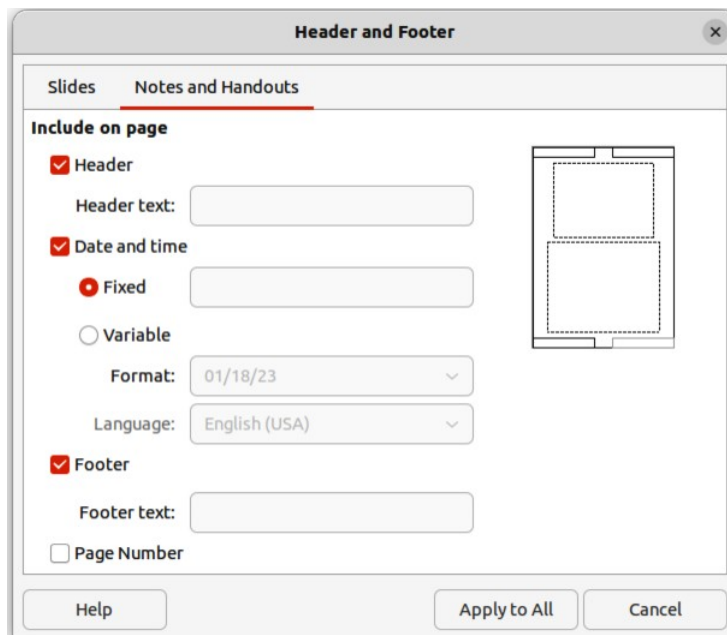

Figure 175: Header and Footer dialog — Notes and Handouts page

3) Click on **Notes and Handouts** tab and select the required header and footer options as follows:

- Select *Header* then enter text in the *Header text:* text box.
- Select *Date and time* then select either *Fixed* or *Variable* for the date and time.
- If a fixed date and time was selected, enter the date and/or time in the text box.

- If a variable date and time was selected, select the *Format* for the date and time in the drop-down list.
 - If a variable date and time was selected, select the *Language* to set the options for the date and time format in the drop-down list.
 - Select *Footer* then enter text in the *Footer text:* text box.
 - Select *Page Number* if the handout pages are to be numbered.
- 4) Click on **Apply to All** to save the options for the handouts and close the Header and Footer dialog.
 - 5) Go to **File > Print** on the Menu bar or use the keyboard shortcut *Ctrl+P* (macOS $\text{⌘}+P$) to open the Print dialog and click on the **LibreOffice Impress** tab to open the page for printing options of handouts. An example Print dialog for LibreOffice Impress is shown in Figure 176.

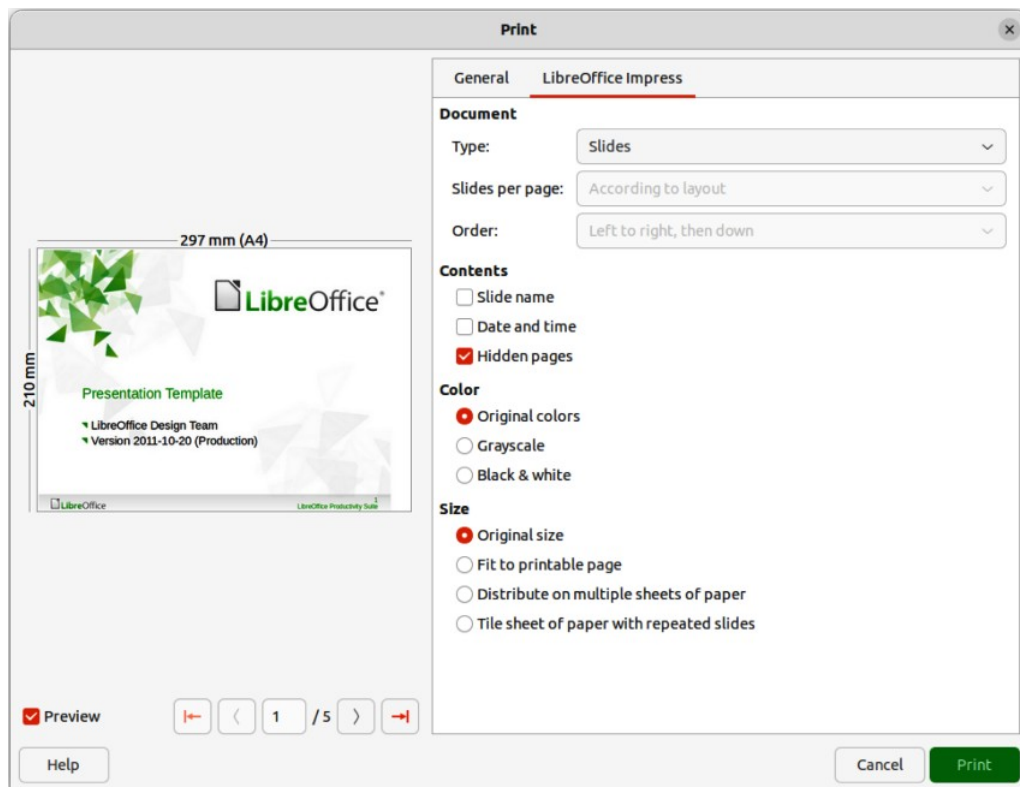

Figure 176: Example Print dialog — LibreOffice Impress page

- 6) In **Document**, select the required options in the drop-down lists as follows:
 - *Type:* – select *Handouts* in the drop-down list.
 - *Slides per page:* – select how many slides are printed on a sheet of paper.
 - *Order:* – select the order in which the slides are printed on a sheet of paper.
- 7) In **Contents**, select *Slide name*, *Date and time*, and/or *Hidden pages* if these items are to be printed.
- 8) In **Color**, select how the handouts are printed.
- 9) In **Size**, select the size for how the handouts are printed.
- 10) Click on **Print** to print the handouts and close the Print dialog.

Creating a photo album

Impress can create a photo album from a set of photographs and images. The photo album can be a multimedia show with vacation pictures and/or graphics and images as a presentation file.

- 1) Create a new presentation or open an existing presentation.
- 2) Select the slide that is going to precede the photo album. In a new presentation, this will be the first slide.
- 3) Go to **Insert > Media > Photo Album** on the Menu bar to open the Create Photo Album dialog (Figure 177).
- 4) Click on **Add** to open a file browser and navigate to the folder where the images are located.
- 5) Select the images required and click **Open**. This closes the file browser and the selected files appear in the Create Photo Album dialog.
- 6) Select the number of images per slide in the *Slide layout*: drop-down list.

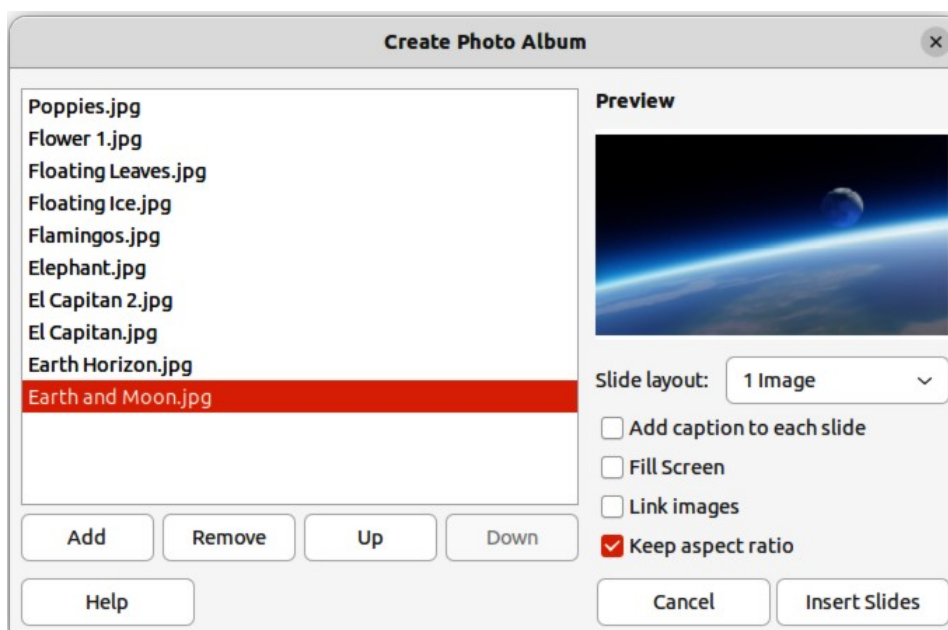

Figure 177: Create Photo Album dialog

- 7) If required, select *Add caption to each slide*. This inserts a text box on each slide allowing captions to be added to the images.
- 8) If required and there is only one image per slide, select *Fill Screen* for each image to fill the entire slide.
- 9) Create the required sequence of photos or pictures by moving image files up or down in the list of images.
- 10) When the sequence of images is ready, click **Insert Slides** to create the number of slides required for the photo album. The sequence can be changed later.
- 11) If required, copy and paste images between slides as with any other elements that can be placed on a slide.
- 12) If required, set up the photo album to run as a presentation. See “Presentations (slide shows)” below, “Running presentations” on page 274, and the *Impress Guide*.

Presentations (slide shows)

Impress allocates reasonable default settings for presentations, while at the same time allowing for customizing many aspects of the presentation experience. This section provides an introduction to presentations. For more information on creating, formatting and running presentations, see the *Impress Guide*.

Most of the tasks are best done in **Slide Sorter** view in the Workspace where the majority of the slides in a presentation can be viewed. Go to **View > Slide Sorter** on the Menu bar or click on the **Slide Sorter** tab at the top of the Workspace.

Multiple presentations — single set of slides

There maybe more slides than the time available for a presentation, or only a brief overview is required first and then a more detailed presentation at a later date. Impress provides two tools for this: hiding slides and custom slide shows.

Hiding slides

- 1) Select slides for hiding in the Slides pane, or **Slide Sorter** view in the Workspace.
- 2) Hide the selected slides using one of the following methods. Hidden slides are grayed out in the Slides pane or Slide Sorter view in the Workspace.
 - Go to **Slide > Hide Slide** on the Menu bar.
 - Right-click on the slide thumbnail and select **Hide Slide** in the context menu.
 - Click on **Hide Slide** in the Slide View toolbar.
- 3) To show a hidden slide, use one of the following methods.
 - Go to **Slide > Show Slide** on the Menu bar.
 - Right-click on the hidden slide thumbnail and select **Show Slide** in the context menu.
 - Click on **Show Slide** in the Slide View toolbar.

Custom slide shows

- 1) Select the slides required for a custom slide show in the **Slides** pane or **Slide Sorter** view in the Workspace.
- 2) Go to **Slide Show > Custom Slide Show** on the Menu bar to open the Custom Slide Shows dialog (Figure 178).
- 3) Click on **New** and the Define Custom Slide Show dialog opens (Figure 179).
- 4) Type a name for the new custom slide show in the **Name** text box.
- 5) In the **Existing slides** list, select the slides to include in the show.

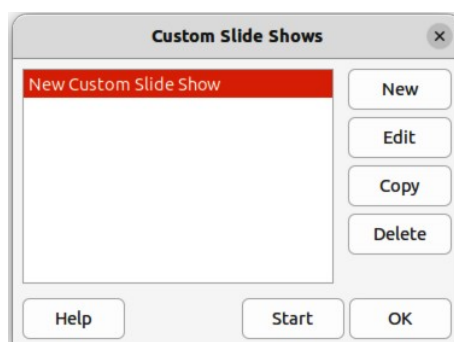



Figure 178: Custom Slide Shows dialog

- 6) Click the >> button to include the slides in the **Selected slides** list. Several slides can be selected and included at the same time. Hold down the *Shift* key and click the first and last slide in a group to select that group, or hold down the *Ctrl* key (macOS ) and click on individual slides to select them.

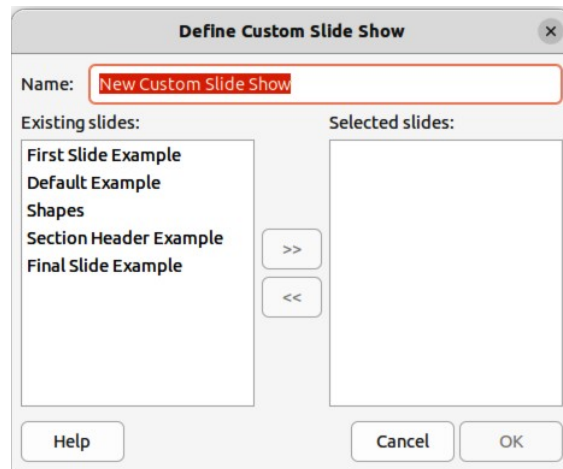

Figure 179: Define Custom Slide Show dialog

- 7) If required, rearrange the slide order in the **Selected slides** list. Click on a slide name and drag it to a new position in the list, then release the mouse button.
- 8) Click **OK** to save the custom slide show and return to the Custom Slide Shows dialog.
- 9) To activate a custom show, select it in the list in the Custom Slide Shows dialog and then select the **Use custom slide show** option.
- 10) Click **Start** to test the custom slide show or click **OK** to close the Custom Slide Shows dialog.

Slide Show Settings

The slide show can be customized with specific settings. Open **Slide Show > Slide Show Settings** to open the dialog of Figure 180. The settings are saved to the local configuration.

Range

These settings affects the whole presentation and the initial slide to display or the custom slide show to present.

Presentation Mode

Sets the full screen or windowed or a loop suitable for unattended slide show

Presentation options

Many settings for

Display

Settings for the presentation screen, presenter console, and navigation bar for the show. See Presenter Console below.

Remote Control

The remote control is a mobile application to control the presentation on a cell phone or tablet. The systems supported are Android and IOS. Click on the link to download the Remote control application from the appropriate application store for the mobile device. The remote control application operates with bluetooth connections or wi-fi network.

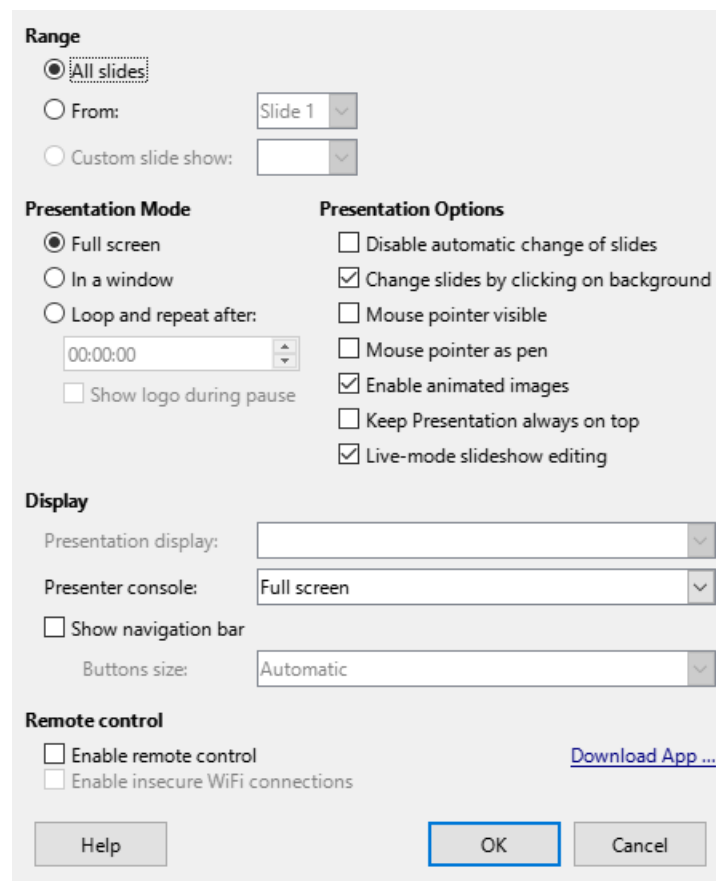

Figure 180: Slide Show Settings dialog

Slide transition

Slide transitions are effects and/or sounds that take place between slides when slides change in a presentation and can add a professional look to a presentation, smoothing the change over between slides. For more information on how to setup slide transitions, modify slide transitions, and to advance slides in a presentation, see the *Impress Guide*.

- 1) Click on **Slide Transition** in the Sidebar to open the Slide Transition deck (Figure 181).
- 2) In the **Slides** pane or **Slide Sorter** view in the Workspace, select the slides where slide transitions are going to be applied.
- 3) Select a transition from the available options in the **Slide Transition** panel.
- 4) In the **Modify Transition** panel, select from the following options to modify the selected transition:
 - *Variant* — if available, select a slide transition variant from the options available in the drop-down list.
 - *Duration* — enter a duration time in seconds for slide transition.
 - *Sound* — from the options available in the drop-down list, select a sound or music, to be played during slide transition.
- 5) To apply the same transition to all slides in the presentation, click **Apply Transition to All Slides** at the bottom of the Slides Transition deck.

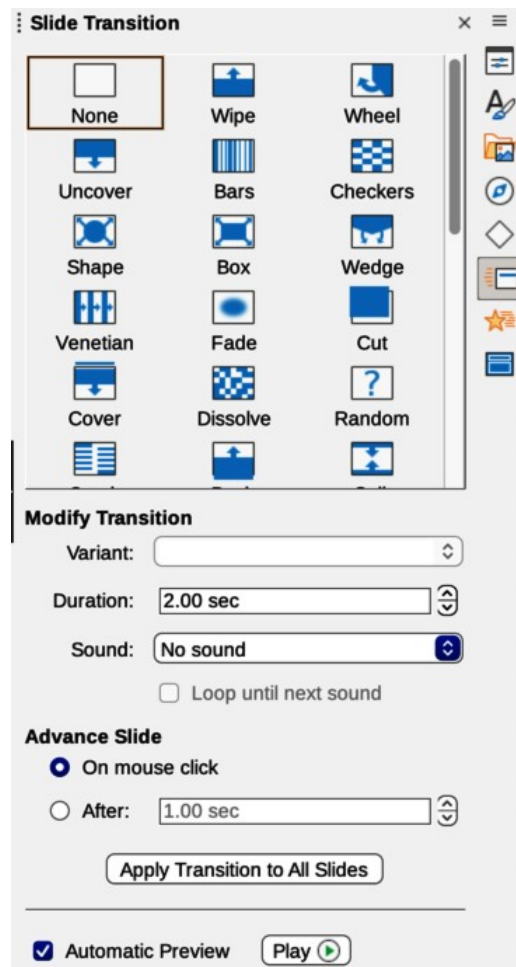

Figure 181: Slide Transition deck in Sidebar

- 6) To check how the transition looks, click *Play* at the bottom of the Slides Transition deck. Alternatively, to automatically preview how the transition looks when it is applied, select **Automatic Preview** at the bottom of the **Slides Transition** deck.
- 7) In the **Advance Slide** section, select how the slides change in a presentation.
 - *On mouse click* — each time the mouse is clicked, the presentation advances to the next slide.
 - *Automatically after* — enter a time in box to elapse before the next slide in the presentation advances into view.

Playing sounds or music

Sound or music can be played during a presentation as a transition effect. When using music in a presentation, make sure any copyright or license for the music is not being infringed.

- 1) Click on **Slide Transition** on the Sidebar to open the Slide Transition deck.
- 2) In the **Slides** pane, or **Slide Sorter** view in the Workspace, select the slide to add sound or music.
- 3) In the **Modify Transition** panel, select a sound in the *Sound* drop-down list.
- 4) To play music, use the following steps to select a music file:
 - a) Select *Other sound* in the **Sound** drop-down list.
 - b) In the file browser window that opens, navigate to where the music file is located.

- c) Select the music file required and click **Play** to check if the music is suitable.
 - d) If the music is suitable, click **Open** to add the music to the selected slide and close the file browser window.
- 5) To play a sound or music file continuously in the slide show, select the option *Loop until next sound*. The sound or music file restarts once it is finished until the next sound or music file that is inserted in the slide show.

Notes

Do not select the *Apply Transition to All Slides* option, otherwise the selected music file restarts at every slide.

The sound or music file is linked to a presentation rather than embedded. If the presentation is going to be displayed on a different computer, remember to make sure that the music file is available on the computer where the presentation will be played. The link to the sound or music file must be established before starting the presentation.

Animation effects

Slide animations are similar to transitions, but they are applied to individual elements in a single slide, such as title, chart, shape, or individual bullet point. Animations can make a presentation more lively and memorable. However, as with transitions, heavy use of animations can be distracting and even annoying for an audience expecting a professional presentation.

Animations are best applied using **Normal** view in the Workspace so that individual objects on a single slide can easily be selected.

On a slide, an element, such as a graphic or an entire text box, has selection handles around it when selected. If a portion of the text in a text box is selected, any selection handles may not be visible. For more information on animation effects, see the *Impress Guide*.

- 1) Go to **View > Normal** on the Menu bar to open **Normal** view in the Workspace.
- 2) Select an element on a slide for animation.
- 3) On the Sidebar, select **Animation** to open the Animation deck (Figure 182).
- 4) Select an element in the Animation panel.
- 5) In the **Effects** panel, click on *+Add* to open the animation options.
 - a) In *Category*, select an animation category from the drop-down list.
 - b) In *Effect*, select an animation effect from the available options.
 - c) In *Start*, select how the animation starts from the drop-down list.
 - d) In *Direction*, select the direction of the animation from the drop-down list.
 - e) In *Duration*, enter a time in seconds for the animation duration.
 - f) In *Delay*, enter a time in seconds for to create a delay before the animation starts.
- 6) If required, select **Automatic Preview** to check the effect of the animation to a slide element.
- 7) Click **Play** to check how the animation effect when applied to a slide element.

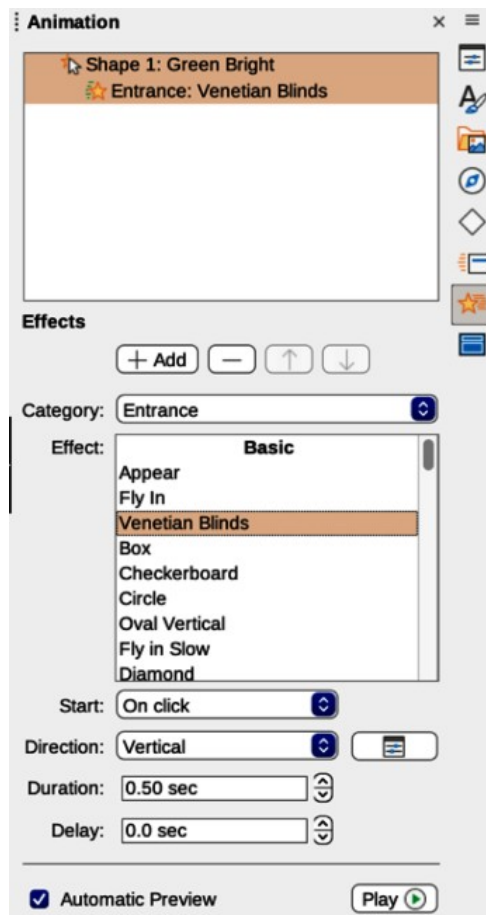

Figure 182: Animation deck in Sidebar

Running presentations

- 1) Open the presentation and start the slide show using one of the following methods:
 - Use the keyboard shortcut *F5* to start from the first slide, or *Shift+F5* to start from the current slide.
 - Go to **Slide Show > Start from First Slide**, or **Start from Current Slide** on the Menu bar.
 - Click on **Start from First Slide** on the Slide Sorter toolbar.
- 2) If the slide transition is set to start after a time delay set in *After* on the **Advance Slide** panel, the transition runs after the time delay has elapsed and advances to the next slide.
- 3) If the slide transition is set to *On mouse click* on the **Advance Slide** panel, use one of the following options to for the transition to work and advance to the next slide:
 - Click the left mouse button.
 - Press the down arrow key
 - Press the right arrow key.
 - Press the page down key.
 - Press the space bar.
- 4) To navigate backwards through a slide show one slide at a time, use one of the following options:

- Press the up arrow key.
 - Press the left arrow key.
 - Press the page up key.
- 5) To access more navigation options during a slide-show, right-click on a slide and use the options available in the context menu.
 - 6) When the last slide has displayed, the message *Click to exit presentation* is displayed on screen. Press the *Esc* key, or click the left mouse button to exit the slide show.
 - 7) To exit the slide show and return to the Impress workspace at any time, press the *Esc* key during the slide show.

Note

During the presentation, any animations on a slide are run in the specified order as the slide is displayed.

Presenter Console

The Presenter Console provides extra control over slide shows when using dual displays, such as a laptop and a large display, or projector, for an audience. The view seen on a laptop display includes the current slide that can be seen by the audience, the next slide in the presentation, any slide notes, and a presentation timer.

Note

The Presenter Console only works with computers and operating systems that support two displays. When two displays are being used, one display can be a laptop.

The Presenter Console has to be enabled in Impress before use. Go to **Tools > Options > LibreOffice Impress > General** (macOS **LibreOffice > Preferences > LibreOffice Impress > General**) and select *Enable Presenter Console* in **Presentation**.

- **Default view** — displays the current slide, including any effects and the next slide in the presentation (Figure 183). Click on the *Previous* and *Next* arrows to navigate through the presentation.
- **Notes view** — click on *Notes* to switch to display any notes that accompany each slide in the presentation (Figure 184). Click on *Notes* again to return to the default view.
- **Slides view** — click on *Slides* to switch to display the slide thumbnails that are being used for the presentation (Figure 185). Click on *Slides* again to return to the default view.
- **Exchange** — click on this icon to switch the Presenter Console between displays.

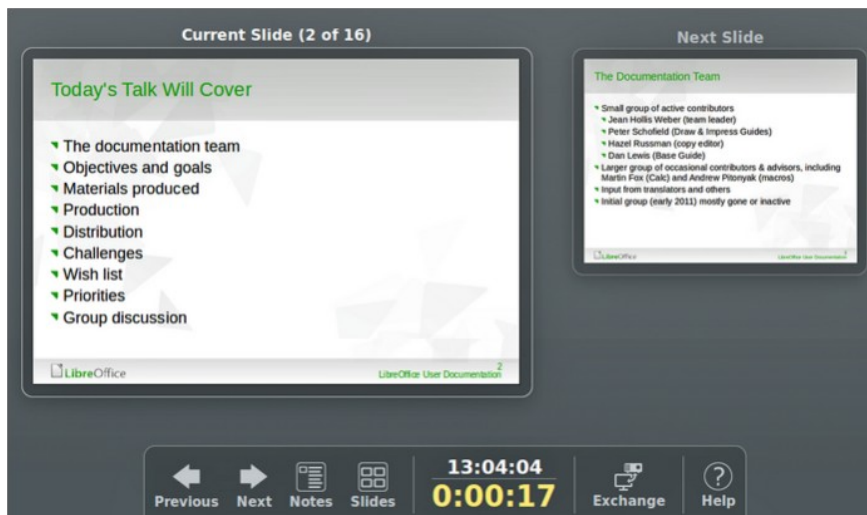

Figure 183: Presenter Console — Default view

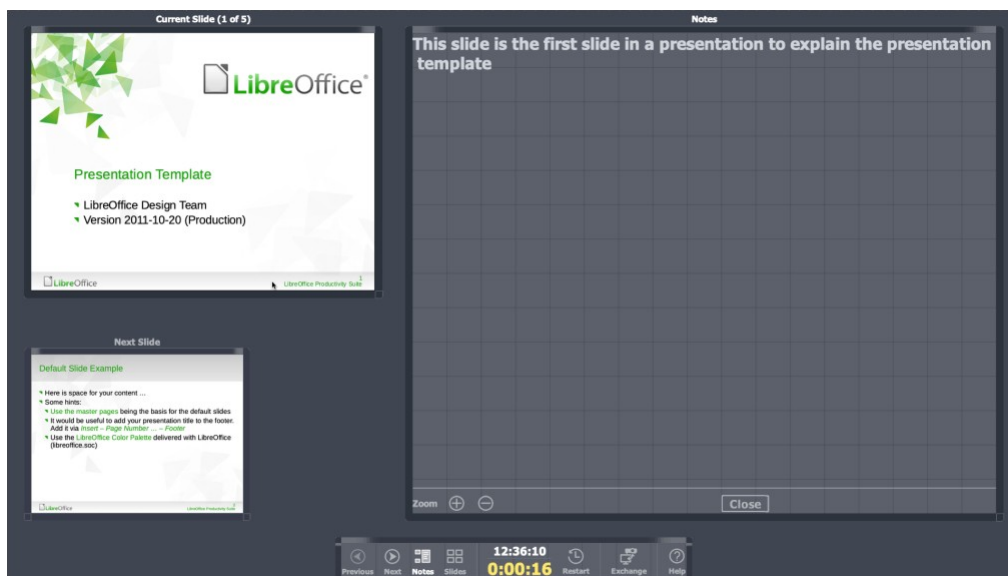

Figure 184: Presenter Console — Notes view

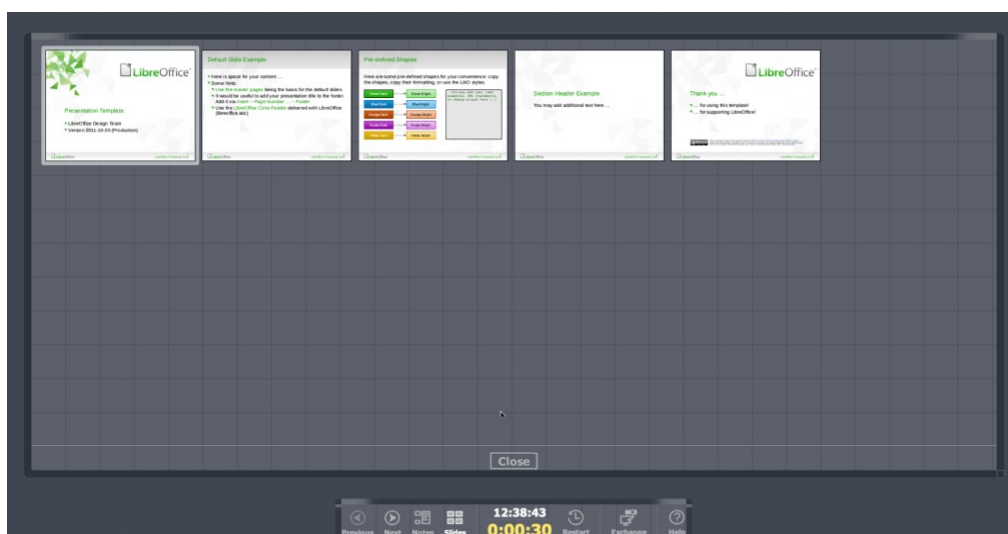

Figure 185: Presenter Console — Slides view



LibreOffice
Community



Chapter 7, Getting Started with Draw

Vector Drawing in LibreOffice

Introduction

LibreOffice Draw is the vector graphics drawing module included with the LibreOffice installation. It can be used to create a wide variety of graphic images, including some operations on raster graphics.

Vector graphics store and display an image as an assembly of simple geometric elements such as lines, circles, and polygons, rather than a collection of pixels (points on the screen). Vector graphics allow for easier storage and image scaling.

LibreOffice Draw is fully integrated into the LibreOffice suite simplifying exchanging graphics between all LibreOffice modules. If an image is created in LibreOffice Draw, reusing it in a LibreOffice Writer document is relatively easy. For example, select and copy a drawing in LibreOffice Draw, then paste the copied image directly into a LibreOffice Writer document. Also, drawings can be worked on directly from within LibreOffice Writer or Impress, using a subset functions and tools from LibreOffice Draw.

The functionality of LibreOffice Draw is extensive has not been designed to rival high-end graphics applications. However, LibreOffice Draw has more functionality than drawing tools that are available in the majority of office productivity suites. A few examples of drawing functions are as follows:

- Layer management
- Magnetic grid-point system
- Dimensions and measurement display
- Connectors for making organization charts and other diagrams
- 3D functions for creating small three-dimensional drawings
- Drawing and page-style integration
- Bézier curves

This chapter introduces some features of LibreOffice Draw, but does not cover all the available features in LibreOffice Draw. See the *LibreOffice Draw Guide* and LibreOffice Help for more information.

Notes

When LibreOffice is installed on a computer, a menu entry for each module is added to the system menu. The exact name and location of these menu entries depends on the operating system and graphical user interface being used.

The **New** icon displayed on the Standard toolbar depends on which LibreOffice module is open when creating a new document, presentation, spreadsheet, or drawing.

Main window

Pages pane

In LibreOffice Draw, drawings can be split over several pages with multi-page drawings used mainly for presentations. The **Pages** pane, on the left side of the main window, provides an overview pages created in a drawing. If the **Pages** pane is not visible, select **View > Page Pane** on the Menu bar. To make changes to the page order, drag and drop one or more pages displayed in the **Pages** pane.

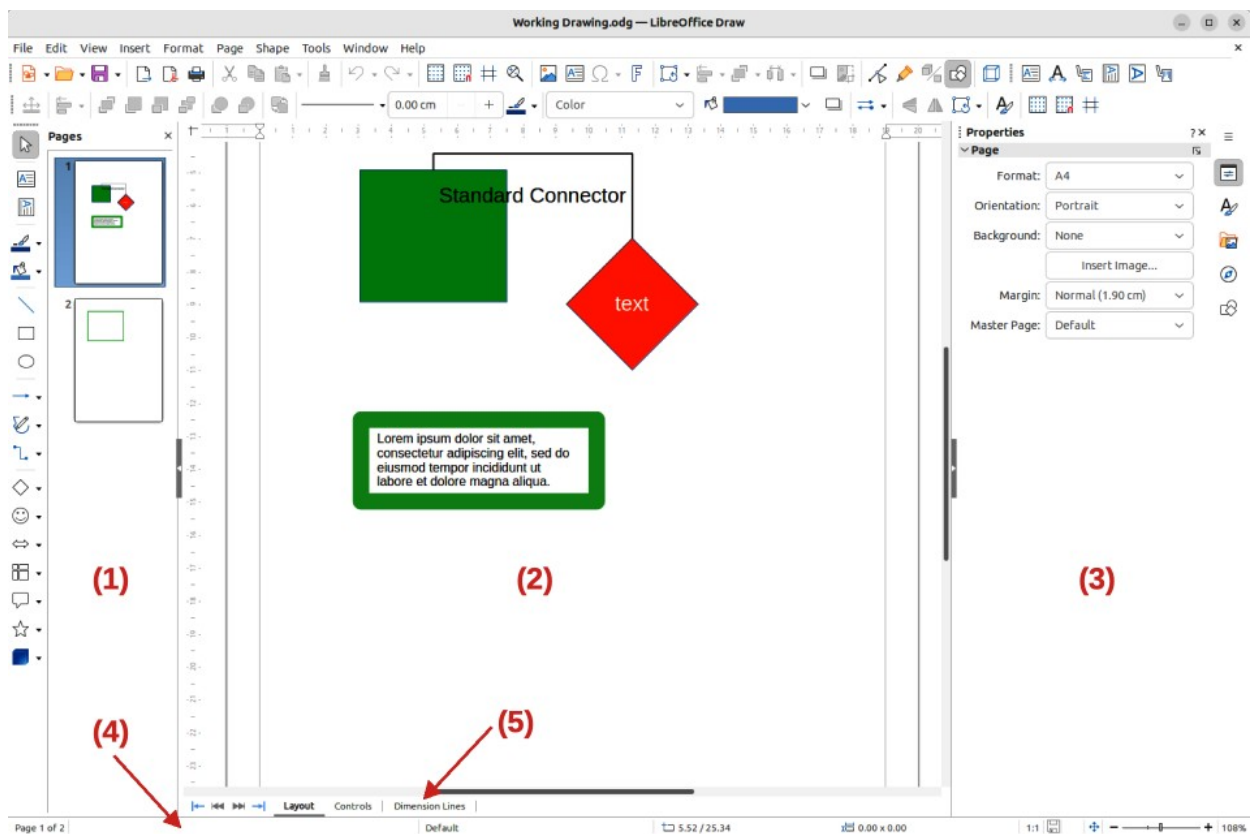

Figure 186: LibreOffice Draw Main Window

- | | | |
|----------------|----------------|----------------|
| (1) Pages pane | (3) Sidebar | (5) Layers Bar |
| (2) Workspace | (4) Status Bar | |

Workspace

The large area in the center of the main window (Figure 186) is the Workspace where drawings are created. This drawing area can be surrounded with toolbars and information areas. The number and position of visible tools varies with the task being carried out, user preferences, and computer setup. The maximum size of a drawing page in LibreOffice Draw is limited by computer setup and the page size that that can be set and used in a printer connected to the computer.

Sidebar

The Sidebar in LibreOffice Draw has five main decks and is similar to the Sidebar in other LibreOffice modules. To open a deck, click on its icon on the right of the Sidebar, or click on **Sidebar Settings** at the top of the Sidebar and select a deck from the drop-down list. If the Sidebar is not visible, select **View > Sidebar** on the Menu bar, or use the keyboard shortcut **Ctrl+F5** (macOS **⌘+F5**).

Properties

Contains panels where properties of a selected object in a drawing are changed: **Page**, **Character**, **Paragraph**, **Image**, **Area**, **Line**, **Effect**, **Shadow**, **Position and Size**, and **Columns**. Available panels depend on the selected object.

Styles

Provides options to edit and apply available **Drawing Styles** to objects in a drawing. When a style is edited or modified, changes are automatically applied to all elements formatted using that style. In LibreOffice Draw, **Presentation Styles** are not available. New drawing styles can be added to a drawing.

Gallery

Objects on the Gallery deck are inserted into a drawing either as a copy or as a link. The Gallery is divided into themes: **Arrows**, **BPMN** (Business Process Model and Notation), **Bullets**, **Diagrams**, **Flow chart**, **Icons**, **Network**, **Shapes**, and **Sounds**. New themes are added to the Gallery. See Chapter 11, Advanced Draw Techniques for more information on using the Gallery.

Navigator

On the Navigator deck, pages and objects in a drawing are quickly selected. It is recommended to use meaningful names for pages and objects in a drawing for easy identification and location when using the Navigator.

Shapes

Provides quick selection of some items available on the Drawing toolbar: **Lines and Arrows**, **Curves and Polygons**, **Connectors**, **Basic Shapes**, **Symbol Shapes**, **Block Arrows**, **Flowchart**, **Callouts**, **Stars and Banners**, and **3D Objects**.

Status bar

The **Status Bar** (Figure 187) is located at the bottom of the Workspace in all LibreOffice modules and includes several LibreOffice Draw specific fields. For content details and use of these fields, see Chapter 1, LibreOffice Basics, and the *LibreOffice Draw Guide*. To hide the **Status Bar**, select **View** on the Menu bar and deselect **Status Bar** from the submenu.

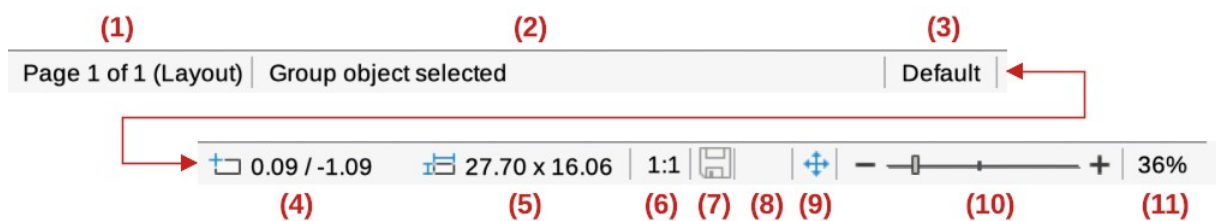

Figure 187: LibreOffice Draw Status Bar

- | | | |
|----------------------------|-----------------------------|----------------------|
| (1) Slide (drawing) number | (5) Selected object size | (9) Fit drawing |
| (2) Information area | (6) Document scaling factor | (10) Zoom slider |
| (3) Master drawing | (7) Unsaved changes | (11) Zoom percentage |
| (4) Cursor position | (8) Digital signature | |

Note

The measurement units displayed on the **Status Bar** are set by going to **Tools > Options > LibreOffice Draw > General** (macOS **LibreOffice > Preferences > LibreOffice > General**) on the Menu bar. These measurement units can be different to the measurement units set for the rulers displayed in the LibreOffice Draw main window.

Layers bar

A layer is a workplace where drawing elements and objects can be inserted. By default, the Workspace consists of three layers (**Layout**, **Controls** and **Dimension Lines**). Tabs for the default layers appear at the bottom of the Workspace. Default layers cannot be deleted or renamed, but layers can be added when required.

Tabs for layers appear in the Layers bar at the bottom of the Workspace. Use the Layers bar to navigate between layers, add layers as required, or delete layers that have been created. For more information on layers, see “Working with layers” on page 313.

Rulers

Rulers are positioned on the Workspace upper and left-hand sides. If the rulers are not visible, select **View > Rulers** in the Menu bar, or use the keyboard shortcut *Ctrl+Shift+R* (macOS *⌘+Shift+R*). The rulers show the size of a selected object on the page using double lines (highlighted in Figure 188). Also, rulers are used to manage object handles and guide lines when positioning objects.

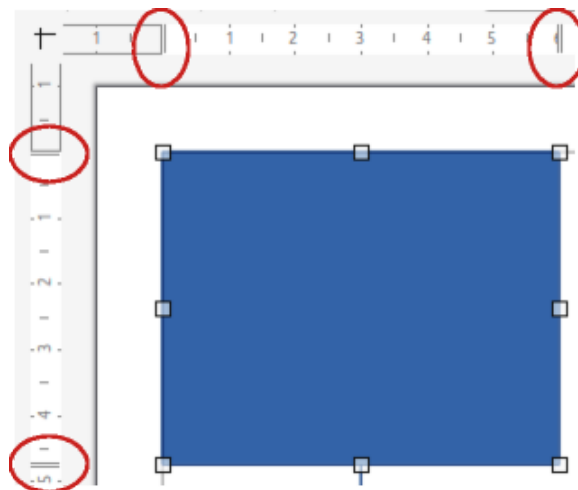

Figure 188: Example of rulers showing object size

Page margins in the drawing area are represented on the rulers. Change the margins directly on the rulers by dragging with the cursor. Margin areas are normally indicated by a grayed out area on the rulers, but does depend on computer operating system and setup.

To change the ruler measurement units, right-click on a ruler and select the measurement unit from the drop down list, as shown in Figure 189 for the horizontal ruler. Measurement units for the horizontal and vertical rulers can be different measurement units.

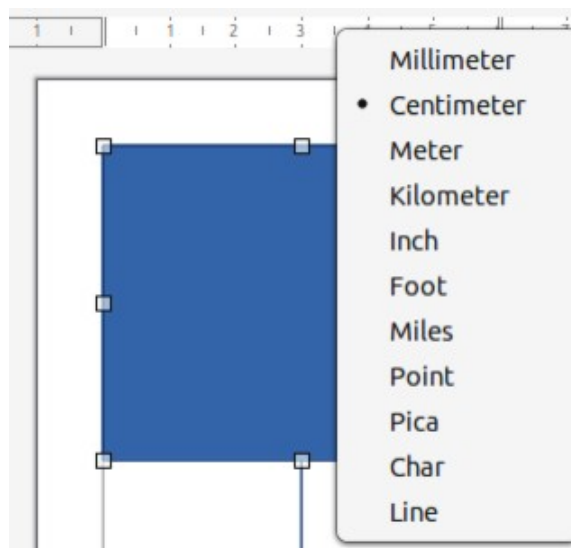

Figure 189: Example of ruler measurement units

Toolbars

To display or hide the LibreOffice Draw toolbars, select **View > Toolbars** on the Menu bar and select the required toolbar from the submenu. For more information on toolbars, see the *LibreOffice Draw Guide*.

The icons used for the tools on each toolbar depend on the computer operating system and how LibreOffice has been set up on a computer. For more information, see Chapter 12, Configuring LibreOffice. The four main toolbars used in LibreOffice Draw are as follows:

Standard toolbar

The Standard toolbar (Figure 190) is similar for all LibreOffice modules. By default, it is locked into position at the top of the main window when a document is opened.

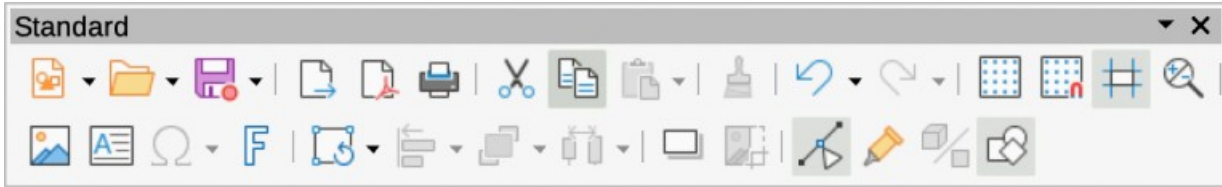

Figure 190: Standard toolbar

Drawing toolbar

The Drawing toolbar (Figure 191) contains all the necessary functions for drawing various geometric and freehand shapes, and for organizing them in the drawing. By default, it is locked into position on the left of the main window.



Figure 191: Drawing toolbar

Line and Filling toolbar

The Line and Filling toolbar (Figure 192) is normally docked at the top of the main window below the Standard toolbar and is used to modify the main properties of a drawing object. The tools and pull-down lists vary according to the type of object selected. The Line and Filling toolbar only becomes active when an object on the Workspace is selected.

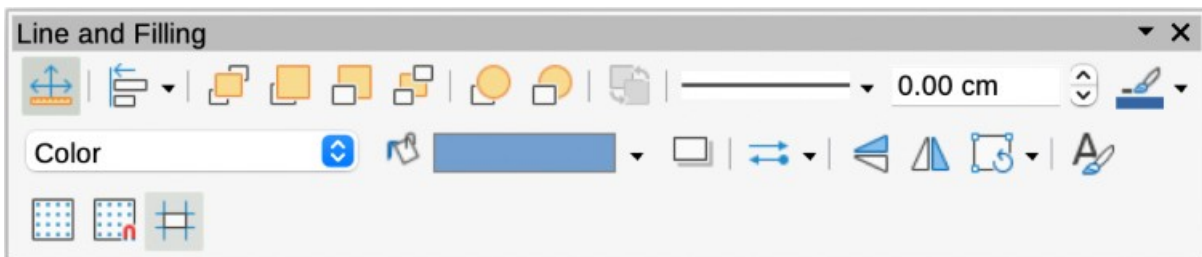

Figure 192: Line and Filling toolbar

Text Formatting toolbar

The Text Formatting toolbar (Figure 193) is similar to the Formatting toolbar in LibreOffice Writer. It is only available when text, or a text object, has been selected in a drawing. The Text Formatting toolbar replaces the Line and Filling toolbar when it opens.

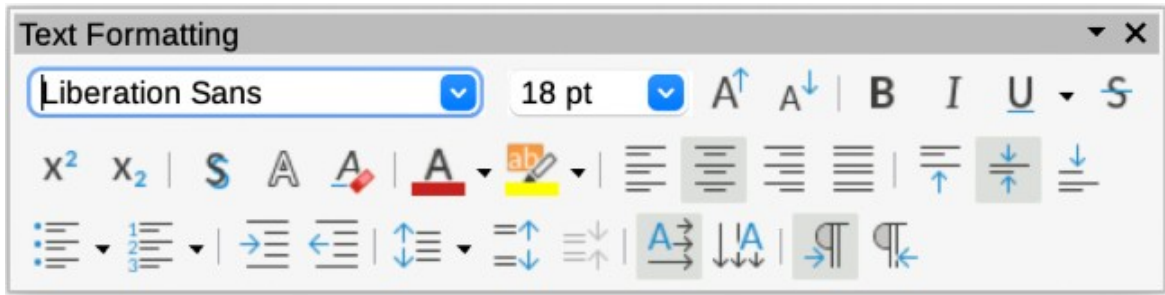

Figure 193: Text Formatting toolbar

Drawing basic shapes

LibreOffice Draw provides a wide range of basic shapes located on the Drawing toolbar (Figure 191 on page 287) and the Shapes deck on the Sidebar (Figure 194). Some of the basic shape icons on the Drawing toolbar change according to the shape that has been selected. Also, some basic shapes on a toolbar have a subtoolbar available and these are indicated by a triangle ▼ to the right of the tool icon. See the *LibreOffice Draw Guide* for a complete description of the basic shapes available and how to access the subtoolbars.

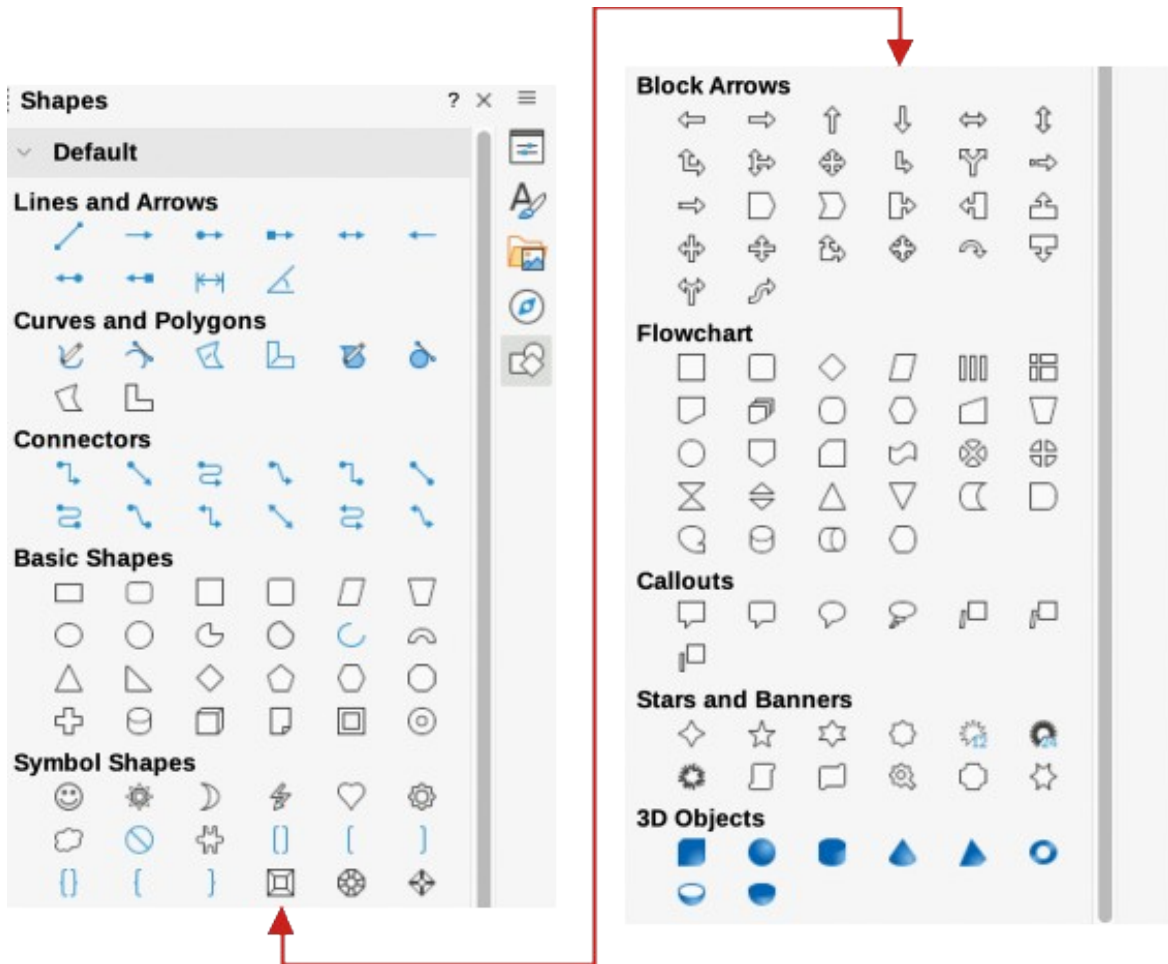

Figure 194: Shapes deck on Sidebar

Note

When drawing basic shapes, or selecting a shape for editing, the information area in the **Status bar** changes to reflect the present action, for example `Line created`, `Text frame xxyy selected`, and so on.

Straight lines

A straight line is the simplest element or object to create in LibreOffice Draw.

- 1) Use one of the following methods to start drawing a line:
 - Click on **Insert Line** on the Drawing toolbar (Figure 191 on page 287).
 - Click the triangle ▼ on the right of **Lines and Arrows** on the Drawing toolbar and select **Insert Line** in the context menu.
 - Click on **Insert Line** in the **Lines and Arrows** panel in the Shapes deck on the Sidebar (Figure 194).
- 2) Place the cursor at the starting point on the drawing, then click and drag the cursor to draw a straight line.
- 3) Release the cursor when the end point is reached and a straight line is created. A selection handle appears at each end of the line, showing that this object is selected. The selection handle at the starting point of the line is larger than the end point (highlighted in Figure 195).

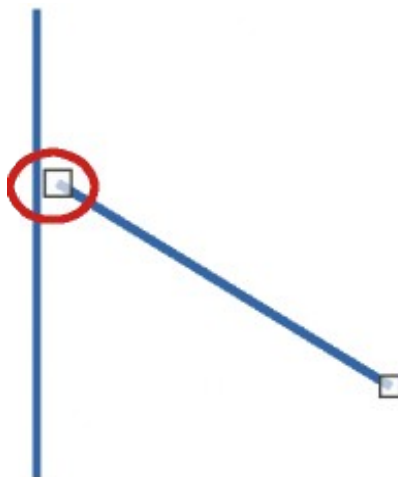

Figure 195: Example of line starting point

A line is drawn using default attributes. To change line attributes and format a line to the drawing requirements, select the line by clicking on it and use one of the following methods to access formatting options for the line:

- Go to the Properties deck on the Sidebar and open the **Line** panel (Figure 196).
- Right-click on a line and select **Line** in the context menu to open the Line dialog (Figure 197).
- Go to **Format > Line** on the Menu bar to open the Line dialog.
- Use the tools **Line Style**, **Line Width**, and **Line Color** on the Line and Filling toolbar (Figure 192 on page 287).

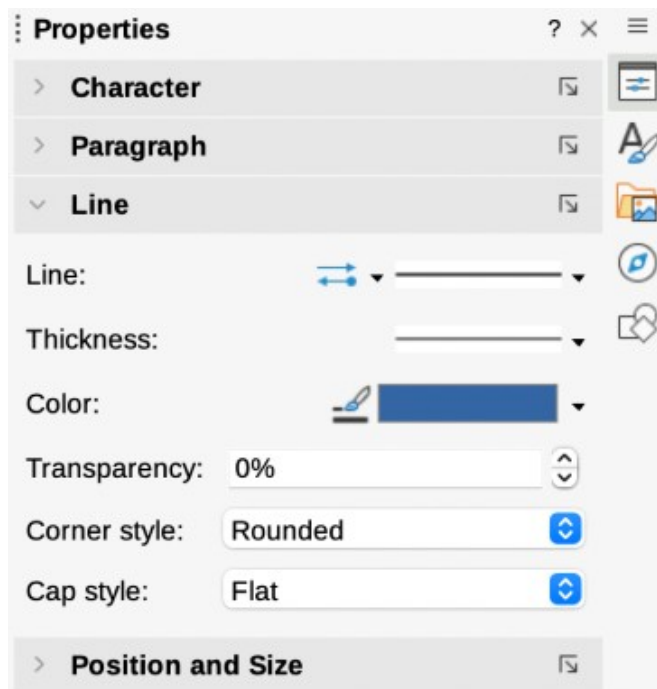

Figure 196: Line panel in Properties deck on Sidebar

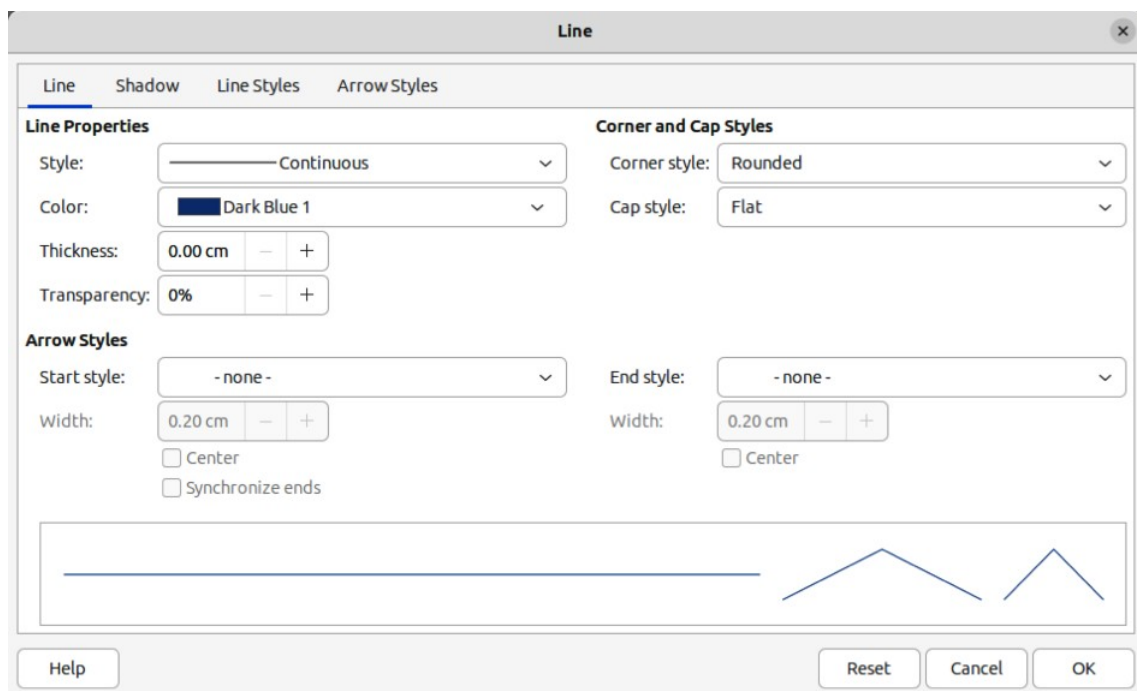





Figure 197: Line dialog — Line page

Tips

To snap the end of a line to the nearest grid point, keep the *Ctrl* key (macOS ) pressed while drawing the line. However, if the **Snap to Grid** option in **View > Snap Guides** on the Menu bar is selected, the *Ctrl* key (macOS ) deactivates the snap to grid.

To restrict the drawing angle of a line to multiples of 45 degrees, keep the *Shift* key pressed while drawing the line. However, if the option **When creating or moving objects** in the *Constrain Objects* section of **Tools > Options > LibreOffice Draw >**

Grid (macOS **LibreOffice** > **Preferences** > **LibreOffice Draw** > **Grid**) has been selected, the *Shift* key deactivates this restriction.

To draw a line symmetrically outwards in both directions from the start point, keep the *Alt* key (macOS ) pressed while drawing the line. Lines are drawn starting from the center of the line.

Lines and Arrows

LibreOffice Draw classifies both lines and arrows as lines. Arrows are drawn like straight lines. Hovering the cursor over each tool in the Lines and Arrows subtoolbar (Figure 198) indicates what type of line, or arrow each tool creates. The information field on the **Status bar** shows them only as lines.



Figure 198: Lines and Arrows subtoolbar

- 1) Use one of the following methods to draw a line or arrow:
 - Click the triangle ▼ on the right of **Lines and Arrows** on the Drawing toolbar and select the type of arrow required from the Lines and Arrows sub-toolbar.
 - Click on the type of arrow required in the **Lines and Arrows** panel of the Shapes deck on the Sidebar (Figure 194 on page 288).
- 2) Place the cursor at the starting point of the line or arrow, then click and drag the cursor. The arrowhead is created when the cursor is released.

Notes

The tool icon for the **Lines and Arrows** tool previously used is shown on the Drawing toolbar making it easier to use the same tool again.

After drawing a line, or arrow, the line, or arrow style is changed by opening the Line dialog (Figure 197 on page 290) and using the options available on the **Line Styles** or **Arrow Styles** pages.

Rectangles or Squares

- 1) Use one of the following methods to start drawing a rectangle or square:
 - Click on **Rectangle** on the Drawing toolbar.
 - Click the triangle ▼ on the right of **Basic Shapes** on the Drawing toolbar and select **Rectangle** or **Square** on the Basic Shapes subtoolbar (Figure 199).



Figure 199: Basic Shapes subtoolbar

- Click on **Rectangle** or **Square** in the **Basic Shapes** panel of the Shapes deck on the Sidebar (Figure 194 on page 288).
- Select the type of rectangle or square on the Legacy Rectangles toolbar (Figure 200). To display the toolbar, go to **View > Toolbars** on the Menu bar and select it.

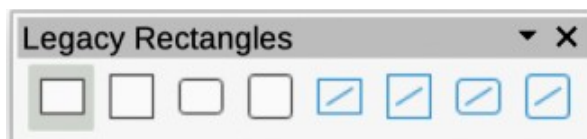

Figure 200: Legacy Rectangles toolbar

- 2) Place the cursor at the starting point for the rectangle or square, then click and drag the cursor until the required size is drawn. The rectangle or square is drawn from the starting point using the bottom right corner as the anchor point for the cursor.
- 3) If necessary, use one of the following options to draw a rectangle or square:
 - If a rectangle option is selected, hold down the *Shift* key while dragging the cursor to draw a square.
 - If a rectangle option is selected, hold down the *Alt* key while dragging the cursor to draw a rectangle from its center.
 - If a rectangle option is selected, hold down the *Shift* and *Alt* keys while dragging the cursor to draw a square from its center.
 - If a square option is selected, hold down the *Shift* key while dragging the cursor to draw a rectangle.
 - If a square option is selected, hold down the *Alt* key while dragging the cursor to draw a square from its center.

Note

If the option *When creating or moving objects* is selected in the **Constrain Object** section of **Tools > Options > LibreOffice Draw > Grid** (macOS **LibreOffice > Preferences > LibreOffice Draw > Grid**), the *Shift* key action is reversed. A square is drawn instead of a rectangle. Holding down the *Shift* key a rectangle is drawn. *Shift* key action reversal also applies to ellipses, circles, arcs, and segments.

Ellipses or circles

- 1) Use one of the following methods to start drawing an ellipse or circle:
 - Click on **Ellipse** on the Drawing toolbar.
 - Select the type of ellipse or circle in the **Basic Shapes** panel in Shapes deck on the Sidebar (Figure 194 on page 288).
 - Click on the triangle ▼ next to **Basic Shapes** on the Drawing toolbar and select the type of ellipse or circle required from the drop-down list.
 - Select the type of ellipse or circle on the Legacy Circles and Ovals toolbar (Figure 201). To display the Legacy Circles and Ovals toolbar, go to **View > Toolbars** on the Menu bar and select it.



Figure 201: Legacy Circles and Ovals toolbar

- 2) Place the cursor at the starting point for the ellipse or circle, then click and drag the cursor until the required size is drawn. The ellipse or circle is drawn from the starting point using the bottom right corner as the anchor point for the cursor.
- 3) If necessary, use one of the following options while drawing an ellipse or circle:
 - If an ellipse option is selected, hold down the *Shift* key while dragging the cursor to draw a circle.
 - If an ellipse option is selected, hold down the *Alt* key while dragging the cursor to draw an ellipse from its center.
 - If an ellipse option is selected, hold down the *Shift* and *Alt* keys while dragging the cursor to draw a circle from its center.
 - If a circle option is selected, hold down the *Shift* key while dragging the cursor to draw an ellipse.
 - If a circle option is selected, hold down the *Alt* key while dragging the cursor to draw a circle from its center.

 **Tip**

To quickly insert an object, press and hold down the *Ctrl* (macOS ) key, then click on an object tool on the Drawing toolbar. A standard sized object of the selected object is drawn automatically in the center of the Workspace. The size, shape, and color used are default settings. These attributes can be changed later. For more information, see the *Draw Guide*.

Dimension lines

Dimension lines display a measurement of an object in the drawing (Figure 202). A dimension line does not belong to the object itself, but is positioned close to it. An object can have as many dimension lines as necessary to indicate the dimensions of sides, edges, distances, and so on.



Figure 202: Example of object dimension lines

- 1) Use one of the following methods to start drawing a dimension line:

Click the triangle ▼ on the right of **Lines and Arrows** on the Drawing toolbar and select **Dimension Line** on the Lines and Arrows sub-toolbar that opens.

- Click on **Dimension Line** in the **Lines and Arrows** panel of the Shapes deck on the Sidebar.
- 2) Place the cursor close to the object to position the start of the dimension line.
 - 3) Click and drag the cursor to draw the dimension line. As the dimension line is drawn, the dimension is displayed and automatically calculated. To change the measurement unit used for dimension lines, go to **Tools > Options > LibreOffice Draw > General** on the Menu bar.
 - 4) To change the display of a dimension line and its appearance, right-click on the dimension line and select **Dimensions** in the context menu to open the Dimension Line dialog (Figure 203).
 - 5) Select the required options in **Line** and **Legend**, then click **OK** to save the changes and close the Line Dimension dialog.

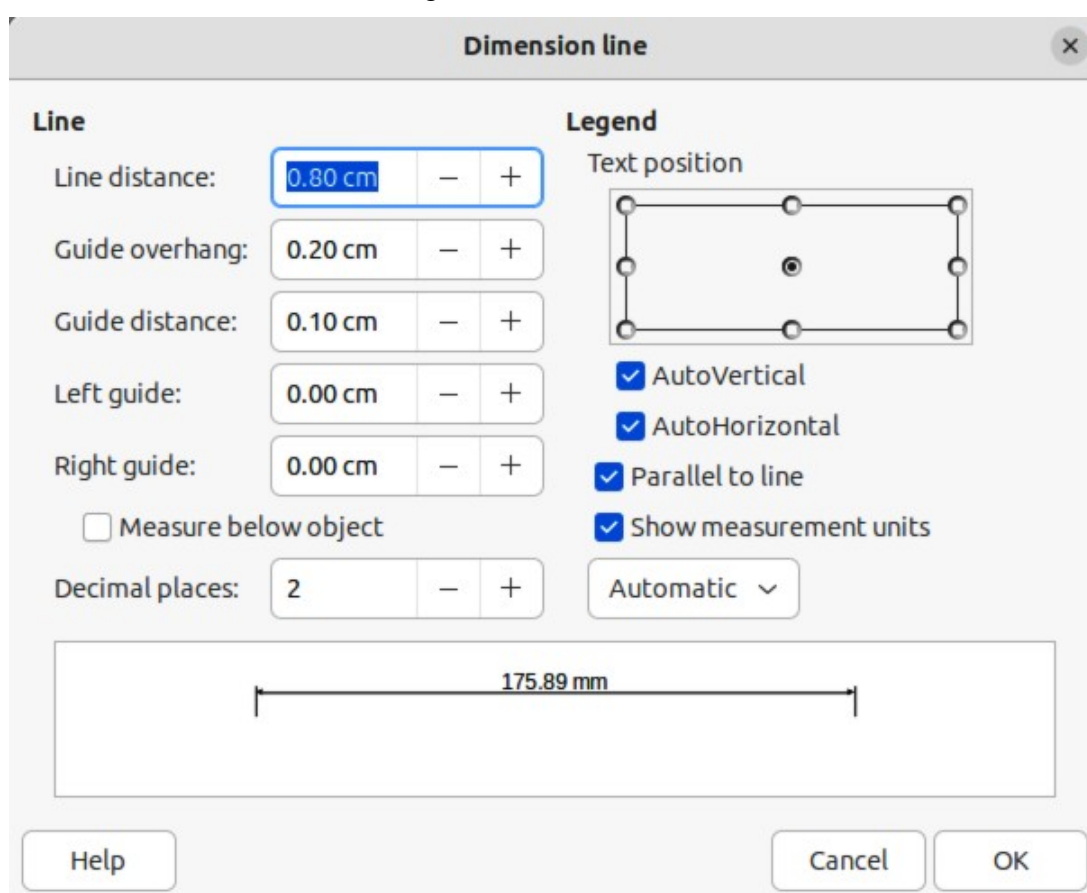

Figure 203: Dimension Line dialog

Curves

- 1) Use one of the following methods to start drawing a curve:
 - Click the triangle ▼ on the right of **Curves and Polygons** on the Drawing toolbar and select the type of curve on the Curves and Polygons subtoolbar (Figure 204).
 - Click on the type of curve required in the **Curves and Polygons** panel of the Shapes deck on the Sidebar.



Figure 204: Curves and Polygons subtoolbar

- 2) Click and hold the left mouse button to create the starting point of the curve, then drag from the starting point to draw a line. Release the mouse button and continue to drag the cursor to bend the line into a curve.
- 3) Double-click to set the end point of the curve and fix the curve on the drawing. A filled curve automatically joins the last point to the first point, closing the curve and filling it with the selected fill color. A curve without fill will not be closed at the end of drawing the curve.

Note

A single click fixes the curve to the drawing and allows drawing of straight lines from the end of the curve. Each single click allows the drawing of another straight line. Double-click to end drawing a curve with straight lines.

Polygons

- 1) Use one of the following methods to start drawing a polygon:
 - Click the triangle ▼ on the right of **Curves and Polygons** on the Drawing toolbar and select the type of polygon on the Curves and Polygons subtoolbar (Figure 204).
 - Click on the type of polygon required in the **Curves and Polygons** panel of the Shapes deck on the Sidebar.
- 2) Click to create the starting point of the polygon, then drag from the starting point to draw a line.
- 3) Release the hold and continue to drag the cursor to draw the next line for polygon, then click again to mark the end point of the line and start drawing another line. Holding the *Shift* key down while drawing lines restricts the angles used in the polygon to 45° or 90°.

Polygons 45°

A polygon 45° is drawn using the same procedure as polygons, but the angles between lines are restricted to 45° or 90°. This restriction of angles cannot be changed. However, hold down the *Shift* key to draw a line at an angle other than 45 or 90 degrees.

A filled polygon 45° automatically joins the last point to the first point, closing the polygon and filling it with the selected fill.

Free-form lines

Drawing a free-form line is similar to drawing with a pencil on paper.

- 1) Use one of the following methods to start drawing a free-form line:
 - Click the triangle ▼ on the right of **Curves and Polygons** on the Drawing toolbar and select the type of free-form line on the Curves and Polygons subtoolbar (Figure 204).
 - Click on the type of free-form line required in the **Curves and Polygons** panel of the Shapes deck on the Sidebar.

- 2) Click and drag the cursor to create the free-form line shape required.
- 3) Release the hold when satisfied with the free-form line and the drawing is completed. A filled free-form line automatically joins the last point to the first point, closing the free-form line and filling it with the selected fill.

Gluepoints and connectors

Gluepoints

All LibreOffice Draw objects have gluepoints and are not normally displayed. Gluepoints (Figure 205) only become visible on an object when a connector is selected on the Drawing toolbar or in the Shapes deck on the Sidebar.

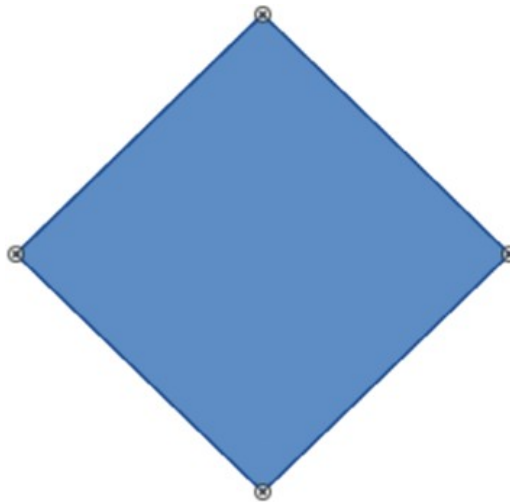

Figure 205: Example of object gluepoints

Most objects have four gluepoints (Figure 205). More gluepoints can be added and customized using the Gluepoints toolbar (Figure 206). If the Gluepoints toolbar is not visible, go to **View > Toolbars > Gluepoints** on the Menu bar to open the toolbar. For a more detailed description on adding and using gluepoints, see the *LibreOffice Draw Guide*.

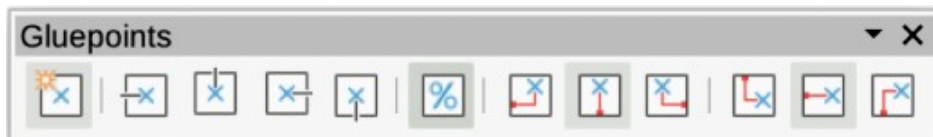

Figure 206: Gluepoints toolbar

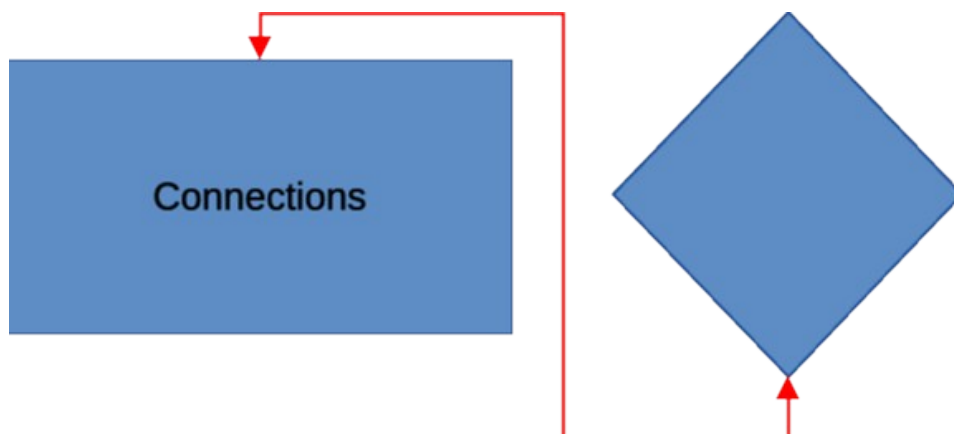

Figure 207: Example of a connector between objects

Gluepoints are not the same as the selection handles of an object. Selection handles are for moving or changing the shape of an object. Gluepoints are used to fix or glue a connector to an object so that when the object moves, the connector stays fixed to the object.

Connectors

Connectors are lines or arrows whose ends automatically snap to a gluepoint of an object. Connectors are especially useful in drawing organization charts, flow diagrams, and mind-maps. When objects are moved or reordered, the connectors remain attached to a gluepoint. Figure 207 shows an example of using two objects and a connector. For a more detailed description of the use of connectors, see the *LibreOffice Draw Guide*.

- 1) Use one of the following methods to select a connector:
 - Click the triangle ▼ on the right of **Connectors** on the Drawing toolbar and select the type of connector on the Connectors subtoolbar (Figure 208).
 - Click on the type of connector required in the **Connectors** panel of the Shapes deck on the Sidebar.



Figure 208: Connectors subtoolbar

- 2) Move the cursor over one of the objects to be connected. Small crosses (the gluepoints) appear around the object edges. Click on the required gluepoint for the start of the connector, then drag the cursor to drag the connector to another object.
- 3) When the cursor is over a gluepoint of the target object, release the mouse button and the connector is drawn. The connector end point is attached to the gluepoint.

Geometric shapes

Geometric shapes are similar to basic shapes. They are provided in LibreOffice Draw as a starting point when creating objects for a drawing. Geometric shapes are located on the Drawing toolbar and in the Shapes deck on the Sidebar.

The tool icons on the Drawing toolbar always indicate the last geometric shape drawn. This makes it easier to use the same tool again.

Access geometric shapes using one of the following methods:

- Click on **Shapes** on the Sidebar to open the Shapes deck, then choose from the geometric shapes available.
- Click the triangle ▼ on the right of a geometric shape on the Drawing toolbar to open a sub-toolbar giving access to more geometric shape tools.

Using geometric shapes is similar to drawing rectangles, squares, ellipses, or circles as explained in “Drawing basic shapes” on page 288. Text can be added to all geometric shapes. See “Adding and formatting text” on page 300 and the *LibreOffice Draw Guide*.

Basic shape



Figure 209: Basic Shapes subtoolbar

The Basic Shapes subtoolbar (Figure 209) also includes rectangle and ellipse tools that are identical to the ones displayed on the Drawing toolbar. **Basic Shapes** are numbered from left to right on the subtoolbar as follows:

- | | | |
|------------------------|---------------------------|--------------------|
| (1) Rectangle | (9) Circle Pie | (17) Hexagon |
| (2) Rectangle, Rounded | (10) Circle Segment | (18) Octagon |
| (3) Square | (11) Arc | (19) Cylinder |
| (4) Square, Rounded | (12) Block Arc | (20) Cube |
| (5) Parallelogram | (13) Isosceles Triangle | (21) Folded Corner |
| (6) Trapezoid | (14) Right-angle Triangle | (22) Cross |
| (7) Ellipse | (15) Diamond | (23) Frame |
| (8) Circle | (16) Regular Pentagon | (24) Ring |

Symbol shapes



Figure 210: Symbol Shapes subtoolbar

Symbol Shapes (Figure 210) are numbered from left to right on the subtoolbar as follows:

- | | | |
|--------------------|----------------------|---------------------|
| (1) Smiley Face | (7) Flower | (13) Double Bracket |
| (2) Heart | (8) Prohibited | (14) Left Bracket |
| (3) Sun | (9) Puzzle | (15) Right Bracket |
| (4) Moon | (10) Square Bevel | (16) Double Brace |
| (5) Cloud | (11) Octagonal Bevel | (17) Left Brace |
| (6) Lightning Bolt | (12) Diamond Bevel | (18) Right Brace |

Block arrows



Figure 211: Block Arrows subtoolbar

Block Arrows (Figure 211) are numbered from left to right on the subtoolbar as follows,;

- | | | |
|--------------------------|--------------------------|-----------------------------------|
| (1) Right Arrow | (10) Right or Left Arrow | (19) Right Arrow Callout |
| (2) Left Arrow | (11) 4-way Arrow | (20) Left Arrow Callout |
| (3) Down Arrow | (12) Corner Right Arrow | (21) Down Arrow Callout |
| (4) Up Arrow | (13) Chevron | (22) Up Arrow Callout |
| (5) Left and Right Arrow | (14) Pentagon | (23) Left and Right Arrow Callout |

- (6) Up and Down Arrow
- (7) Circular Arrow
- (8) S-shaped Arrow
- (9) Split Arrow

- (15) Striped Right Arrow
- (16) Up, Right and Down Arrow
- (17) Notched Right Arrow
- (18) Up and Right Arrow

- (24) Up and Down Arrow Callout
- (25) 4-way Arrow Callout
- (26) Up and Right Arrow Callout

Flowchart

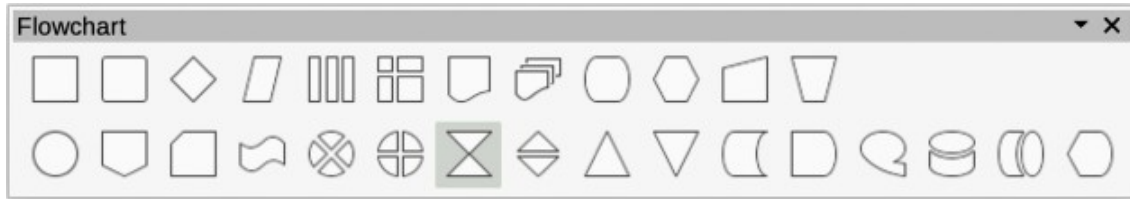

Figure 212: Flowchart subtoolbar

Flowchart (Figure 212) are numbered from left to right on the subtoolbar as follows:

- | | | |
|------------------------|-------------------------|----------------------------|
| (1) Process | (11) Manual Input | (21) Extract |
| (2) Alternate Process | (12) Manual Operation | (22) Merge |
| (3) Decision | (13) Connector | (23) Stored Data |
| (4) Data | (14) Off-page Connector | (24) Delay |
| (5) Predefined Process | (15) Card | (25) Sequential Access |
| (6) Internal Process | (16) Punched Tape | (26) Magnetic Disc |
| (7) Document | (17) Summing Junction | (27) Direct Access Storage |
| (8) Multidocument | (18) Or | (28) Display |
| (9) Terminator | (19) Collate | |
| (10) Preparation | (20) Sort | |

Callouts



Figure 213: Callouts subtoolbar

Callouts (Figure 213) are numbered from left to right on the subtoolbar as follows:

- | | | |
|---------------------------------|--------------------|--------------------|
| (1) Rectangular Callout | (3) Round Callout | (6) Line Callout 2 |
| (2) Rounded Rectangular Callout | (4) Cloud | (7) Line Callout 3 |
| | (5) Line Callout 1 | |

Stars and banners



Figure 214: Stars and Banners subtoolbar

Stars and Banners (Figure 214) are numbered from left to right on the subtoolbar as follows:

- | | | |
|--------------------|---------------------|----------------------------|
| (1) 4-Pointed Star | (5) 12-Pointed Star | (9) Horizontal Scroll |
| (2) 5-Pointed Star | (6) 24-Pointed Star | (10) Signet |
| (3) 6-Pointed Star | (7) Explosion | (11) Door-plate |
| (4) 8-Pointed Star | (8) Vertical Scroll | (12) 6-Point Star, Concave |

3D objects



Figure 215: 3D-Objects subtoolbar

3D-Objects (Figure 215) are numbered from left to right on the subtoolbar as follows:

- | | | |
|--------------|-------------|----------------|
| (1) Cube | (4) Cone | (7) Shell |
| (2) Sphere | (5) Pyramid | (8) Hemisphere |
| (3) Cylinder | (6) Torus | |

Adding and formatting text

Text can be added to drawings created in LibreOffice Draw. This section gives some guidelines on how to add text and change its appearance. Text added to drawings can be contained in text boxes, objects, or shapes. For more information on adding and formatting text, see the *LibreOffice Draw Guide*.

- A text box is an independent object that is dynamic and expands as more text is added within the frame.
- An object or shape in a drawing is not dynamic, which means that the boundary rectangle does not expand as text is added. Care must be taken when adding text to prevent the text from extending outside the object or shape boundaries.

Text mode

Before adding any text to a drawing, text mode has to be activated using one of the following methods. The Text Formatting toolbar (Figure 216) automatically opens when text mode is activated, replacing the Line and Filling toolbar.

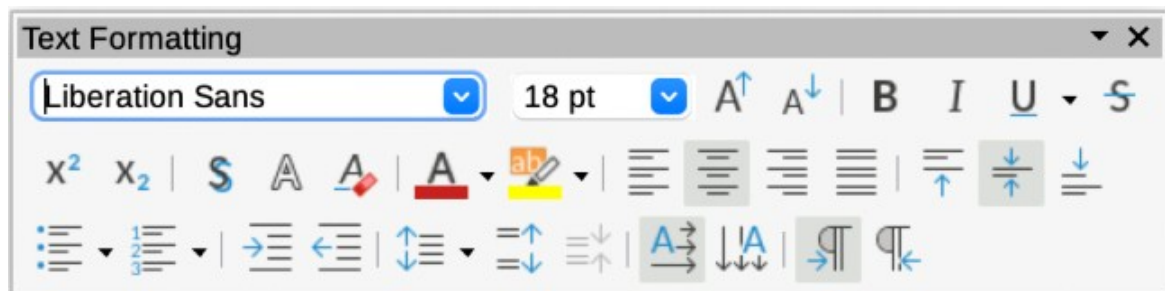

Figure 216: Text Formatting toolbar

- For horizontal text, click on **Insert Text Box** on the Drawing or Text toolbar to create a text box.
- For horizontal text, go to **Insert > Text Box** on the Menu bar to create a text box.
- For horizontal text, use the keyboard shortcut *F2* to create a text box.
- For vertical text, click on **Insert Vertical Text** on the Drawing or Text toolbar to create a vertical text box.
- Double-click inside an object on the drawing and the object switches to text mode with a flashing cursor inside the object.

Note

Inserting and formatting vertical text and vertical text boxes is the same as horizontal text and horizontal text boxes. A vertical text box expands vertically as text is added into the box. For more information on vertical text, see the *LibreOffice Draw Guide*.

Text boxes

- 1) Create a text box in the drawing using one of the following methods. The Status Bar indicates **Text Edit** mode and the position of the cursor (Figure 217).

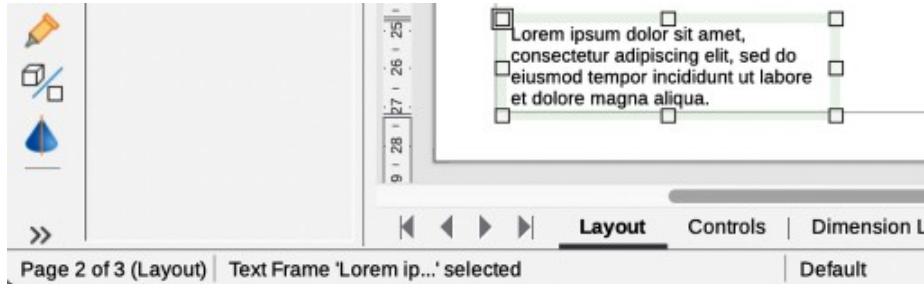

Figure 217: Example of text information on Status Bar

- Click at the approximate position for the text box and a single line text box is created containing a flashing cursor. Start typing the text or paste copied text into the text box. The width of a single line text box increases as text is added.
 - Click at the approximate position for the text and drag the cursor to the approximate width required for the text box creating a multi-line text box. Start typing the text, or paste copied text into the text box. As the horizontal limit of the text box is reached, the text automatically word wraps inside the text box and the text box expands vertically as it fills.
 - If necessary, create multiple lines of text in a single-line text box by pressing *Enter* to create a new paragraph, or using *Shift+Enter* to create a line break in the text.
- 2) When adding text is complete, click outside the text box to exit text mode. The Text Formatting toolbar closes and the Line and Filling toolbar opens in its original position.
 - 3) To format and/or reposition the text box, see the *LibreOffice Draw Guide* for more information.

Vertical text

By default, LibreOffice Draw is set for horizontal text only. Enabling vertical text is as follows:

- 1) Go to **Tools > Options > Language Settings > Languages** (macOS **LibreOffice > Preferences > Language Settings > Languages**).
- 2) Under **Default Languages for Documents**, select *Asian* and accept the default language displayed.
- 3) Right-click in a blank area on the Drawing toolbar and select **Visible Buttons** in the context menu.
- 4) Select **Insert Vertical Text** from the list of available tools to enable vertical text on the Drawing toolbar.
- 5) Alternatively, go to **View > Toolbars** on the Menu bar and select the Text toolbar from the drop-down list, then select **Insert Vertical Text** from the tools available on the Text toolbar.

Text in LibreOffice Draw objects

Text can be added to most LibreOffice Draw objects. The exceptions are, for example, control elements, buttons, polygons, curves, or 3D objects.

By default, an object is not dynamic when created in LibreOffice Draw and does not behave like a text box. Text added to an object does not word wrap inside an object. To keep text within the borders of an object, use word wrap, paragraphs, line breaks, smaller text size, increasing object size, or a combination of all methods. For more information on adding text to objects, see the *LibreOffice Draw Guide*.

- 1) Create an object in a drawing and make sure the object is selected with the selection handles displayed.
- 2) Enter text mode on a selected object using one of the following methods:
 - Click on **Insert Text Box** for horizontal text, or **Insert Vertical Text** for vertical text on the Drawing, or Text toolbar.
 - For horizontal text, double-click on the selected object.
 - For vertical text, double-click on the selected object and click on **Insert Vertical Text** on the Drawing, or Text toolbar.
- 3) Type or paste text into the selected object.
- 4) If the text goes outside the object borders, format the text using the various tools on the Text Formatting toolbar, panels in the Properties deck on the Sidebar, options in **Format** on the Menu bar, or **Text** page in the Text dialog. For more information on text formatting, see the *LibreOffice Draw Guide*.
- 5) Click outside the object to deselect it ending text mode and saving any changes.

Creating lists

Unordered (bulleted) or ordered (numbered) lists can be created in text boxes and objects. For more information on creating and formatting lists, see the *LibreOffice Draw Guide*.

- 1) Switch on text mode and select all of the text required for a list, or type the required text.
- 2) Create a list using one of the following methods and default settings for lists:
 - Click on **Toggle Unordered List**, or **Toggle Ordered List** on the Text Formatting toolbar.
 - Click on **Toggle Unordered List**, or **Toggle Ordered List** in the **Lists** panel in the Properties deck on the Sidebar.
 - Go to **Format > Lists > Unordered List**, or **Ordered List** on the Menu bar.
- 3) To change the format of the list, click on the triangle ▼ on the right of the list tools in the toolbars, or **List** panel in the Sidebar, and select a list style from the options available.

Text columns

Text in a drawing can be formatted into columns inside text boxes and objects. However, if text columns are to be used in a text box or object, then the whole of a text box or object has to be used for columns. For more information on text columns, see the *LibreOffice Draw Guide*.

Note

Any text inside a text box, or graphic object automatically flows into column format when the changes are saved.

- 1) For text boxes — click the border of a text box to select it so that the selection handles are displayed indicating that the text box is in edit mode.
- 2) For graphic objects — double-click on a graphic object to select it so that the selection handles are displayed and the cursor flashes in the center of the object indicating that the object is in text edit mode.
- 3) Open the options for text columns using one of the following methods:
 - Right-click in the text box or graphic object and select **Text Attributes** in the context menu to open the Text dialog, then click on the **Text Columns** tab to open the **Text Columns** page,
 - Click on **Columns** in the Properties deck on the Sidebar to open the **Columns** panel.
- 4) Set the number of columns required in the *Number of columns* box and the required spacing between the columns in the *Spacing* box.
- 5) Type in the required text, or use copy and paste to enter the required text into the text box or graphic object. Any text entered will be in column format.
- 6) If necessary, format the text to the drawing requirements.
- 7) Save the changes and deselect the text box, or graphic object, using one of the following methods:
 - For the Text dialog, click **OK** to save the changes and close the dialog, then click outside the text box to deselect it.
 - For the **Columns** panel in the Properties deck on the Sidebar, click outside the text box or graphic object to deselect it and save the changes.
- 8) Click outside the text box, or graphic object, to deselect and save all the changes.

Selecting objects

Direct selection



The easiest way to select an object is to click directly on it. For objects that are not filled, click on the object border to select it. To select, or deselect, more than one object, hold the *Shift* key down while clicking on each object.

Selection by framing

Several objects can be selected at the same time by clicking and dragging the cursor to create a selection rectangle (also known as a marquee) around objects. Only objects that lie entirely within this selection rectangle are selected. To select multiple objects by framing, **Select** on the Drawing toolbar must be active.

Selecting hidden objects

If objects are located behind others and not visible, they can still be selected. When selecting a hidden object, its selection handles appear through the objects covering it.

- **Windows, macOS or Linux** — press the *Tab* key to select and cycle through the objects in a drawing, stopping at the hidden object to select it. To cycle through the objects in reverse order, press *Shift+Tab*.
- **Windows or macOS only** — select the object in front of a hidden object, then press the *Alt* key (macOS ) and click to select the hidden object. If there are several hidden objects, keep holding down the *Alt* key (macOS ) and clicking until the object

required is reached. To cycle through the objects in reverse order, hold down the *Alt+Shift* keys (macOS $\text{⌘}+\text{Shift}$) and click.

Arranging objects

In a complex drawing, several objects may be stacked on top of one another. This stacking order can be rearranged by moving an object forward, or backward, using one of the following methods:

- Select an object, go to **Shape > Arrange** on the Menu bar, or right-click on the object and select **Arrange** in the drop-down menu, then choose one of the following options:
 - **Bring to Front** (*Ctrl+Shift++*) (macOS $\text{⌘}+\text{Shift}++$)
 - **Bring Forward** (*Ctrl++*) (macOS $\text{⌘}++$)
 - **Send Backward** (*Ctrl+-*) (macOS $\text{⌘}+-$)
 - **Send to Back** (*Ctrl+Shift+-*) (macOS $\text{⌘}+\text{Shift}+-$)
 - **In Front of Object**
 - **Behind Object**
 - **Reverse** — clicking on this option reverses the order of the selected objects.
- Select an object, then click on one of the **Arrange** tools, as above, on the Line and Filling toolbar. When hovering the cursor over a tool, its function is indicated.

Positioning and adjusting objects

When positioning or changing the size of an object, check the information area of the Status bar at the bottom of the Workspace (Figure 218). From left to right, it shows what object is selected, its position on the drawing in X/Y coordinates, and the dimensions of the object.

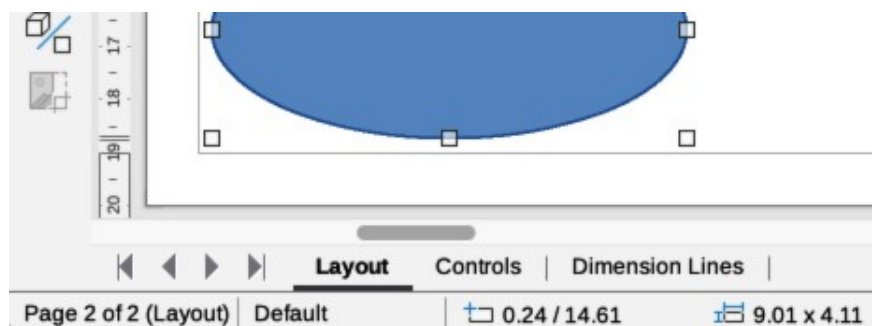

Figure 218: Example of object information on StatusBar

The measurement units are those selected in **Tools > Options > LibreOffice Draw > General**. For more information on positioning and adjusting objects, see the *LibreOffice Draw Guide*.

Using zoom

To help in the positioning and adjustment of objects, LibreOffice Draw has a zoom function that reduces or enlarges the screen display of the current drawing. For example, zoom in to position objects on a drawing with greater accuracy; zoom out to see the complete drawing. Zooming is controlled using the Status bar, Zoom & View Layout dialog, or Zoom toolbar. For more information on using zoom, see the *LibreOffice Draw Guide*.

Moving objects

To move an object (or a group of objects), select it within the object borders, then click and drag the object. Release the object when it is in its correct position. Whilst moving the object, a ghost image of the object appears helping with repositioning (Figure 219).

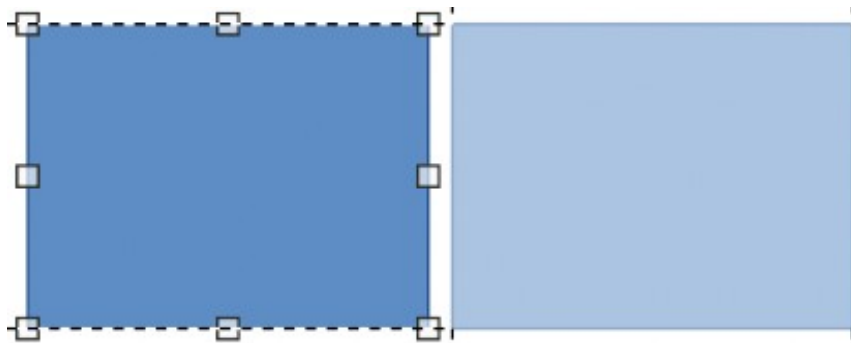

Figure 219: Example of moving objects

Adjusting object size

To change the size of a selected object (or a group of selected objects), move the cursor to one of the selection handles. The cursor changes shape to indicate the direction of movement for that selection handle. As the object size changes, a ghosted outline of the object appears (Figure 220). When the desired size of the object is reached, release the object.

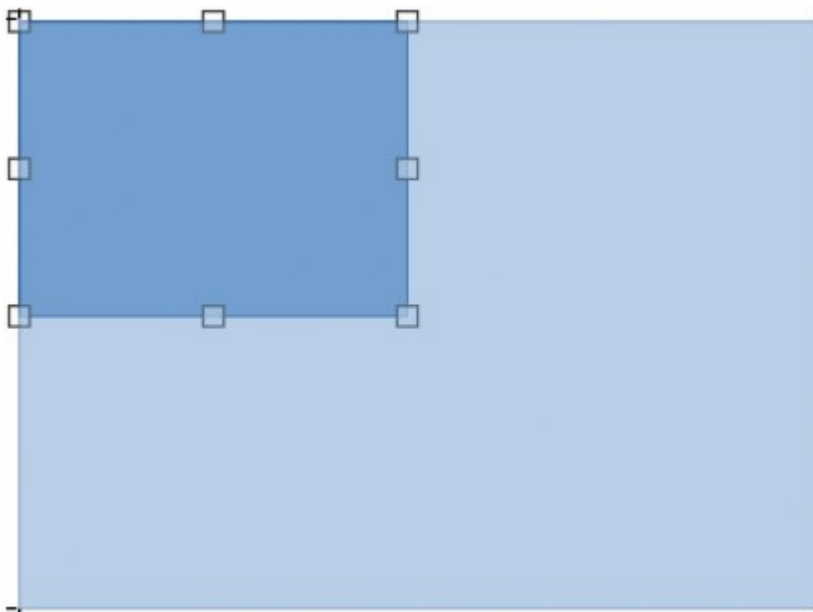

Figure 220: Example of adjusting object size

The results depend on which selection handle is being used. To resize an object along one axis, use a side, top, or bottom handle. To resize along both axes, use a corner handle.

Note

Press and hold the *Shift* key while resizing an object, the change in size is carried out symmetrically with respect to the object width and height maintaining the aspect ratio of the object. This *Shift* key behavior works on all selection handles.

Rotating or slanting objects

To rotate or slant an object (or a group of objects), select it and switch to rotation mode using one of the following methods:

- Right-click on the object and select **Transformations > Rotate** in the context menu.
- Click on the triangle ▼ on the right of **Transformations** on the Standard or Line & Filling toolbars and select **Rotate**.

The selection handles change shape and color with a center of rotation appearing in the center of the object. As the cursor is moved over the handles, the cursor changes shape to indicate the type of movement.

Rotation

- 1) Click on and hold a corner selection handle, then drag the cursor to rotate the object around the rotation point. A ghost image of the object rotation appears and the current angle of rotation is shown in the Status Bar (Figure 221).

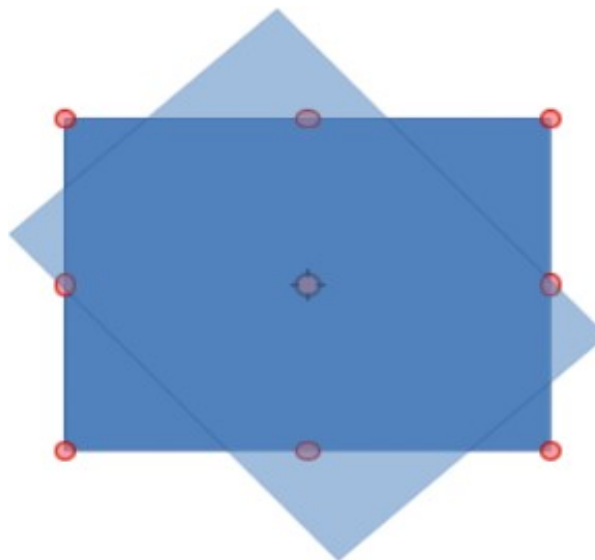

Figure 221: Example of rotating an object

- 2) When the object is at the required rotation angle, release the object.
- 3) To change the type of rotation, click on the rotation point and drag it to another position. The rotation point can be moved outside of the object boundaries.

Note

Press the *Shift* key while rotating or slanting an object and the movement is restricted to 15°.

Slanting

- 1) Click on a selection handle at the top, bottom, left side, or right side of an object. The cursor will change shape indicating the direction of movement.
- 2) Drag the selection handle to slant the object. A ghost image of the object being slanted appears (Figure 222) and the current slant angle is shown in the Status Bar. The axis used for slanting an object is fixed to the edge of the object directly opposite the selection handle being used to slant the object.
- 3) When the object is at the desired slant angle, release the object.

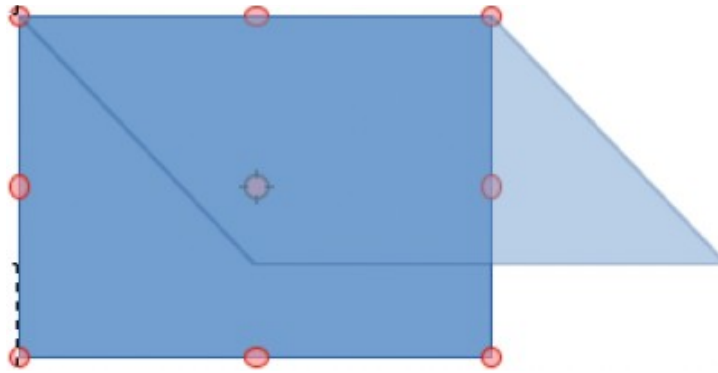

Figure 222: Example of slanting an object

Flipping objects

Select an object so that the selection handles are displayed and flip the object vertically or horizontally using one of the following methods:

- Right-click on the object and select **Flip > Vertically**, or **Horizontally**, in the context menu.
- Go to **Shape > Flip > Vertically**, or **Horizontally**, on the Menu bar.
- Click on **Vertically**, or **Horizontally**, tool on the Line and Filling toolbar.
- Use **Flip Vertically**, or **Flip Horizontally**, tool in the *Position and Size* section on the Properties deck of the Sidebar.

However, the **Flip** tool on the Transformations toolbar (Figure 223) provides greater control over the flipping process. Use the **Flip** tool to change the position and angle that the object flips over. See the *LibreOffice Draw Guide* for more information.



Figure 223: Transformations toolbar

Object distortion

Three tools on the Transformations toolbar (Figure 223) allow the dragging of the corners and edges of an object to distort an object.

- **Distort** — distorts an object in perspective.
- **Set in Circle (perspective)** — creates a pseudo 3D effect.
- **Set to Circle (slant)** — creates a pseudo 3D effect. Despite the (slant) in the name of this tool, it operates differently from the slanting created by rotation.

In all three cases, the object has to be converted into a curve. This is a necessary first step, so click **Yes**, then move the object handles to produce the desired effect. See the *LibreOffice Draw Guide* for more information on how to distort an object.

Dynamic gradients

Transparency gradients can be controlled the same as color gradients and both types of gradient can be used together. With a transparency gradient, the direction and degree of the object fill color changes from opaque to transparent. In a color gradient, the fill changes from one color to

another, but the degree of transparency remains the same. An example of a dynamic gradient is shown in Figure 224.

Two tools on the Transformations toolbar are used to dynamically control transparency and color gradients — **Interactive Transparency** and **Interactive Gradient**. See the *LibreOffice Draw Guide* for more information on how to create transparencies and gradients in an object.

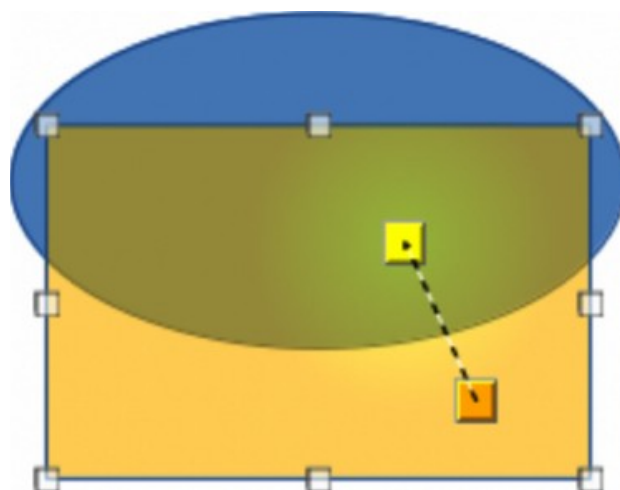

Figure 224: Example of a dynamic gradient

Duplication

Duplication makes copies of an object while applying a set of changes such as Color or rotation to the duplicates that are created. An example of duplication is shown in Figure 225. For more information on duplication, see the *LibreOffice Draw Guide*.

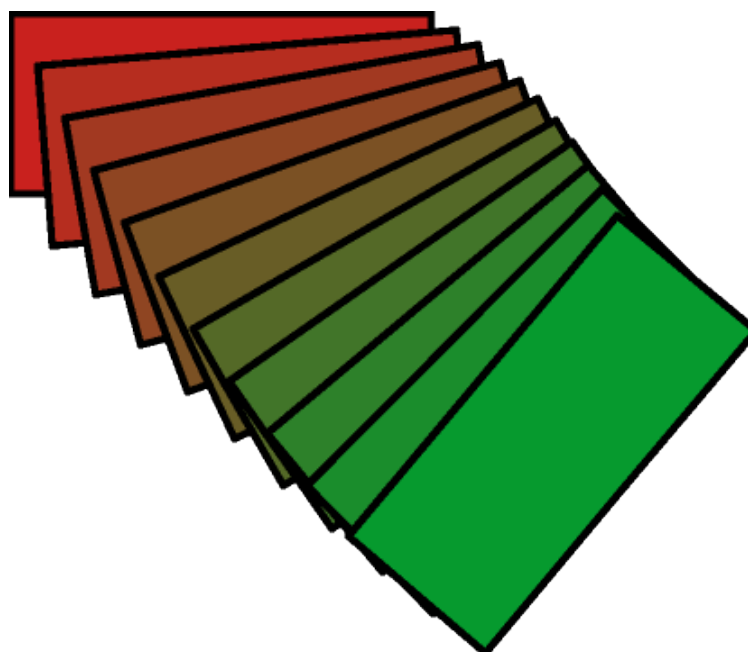

Figure 225: Example of duplicating objects

- 1) Click on an object or group of objects and open the Duplicate dialog (Figure 226) using one of the following methods:

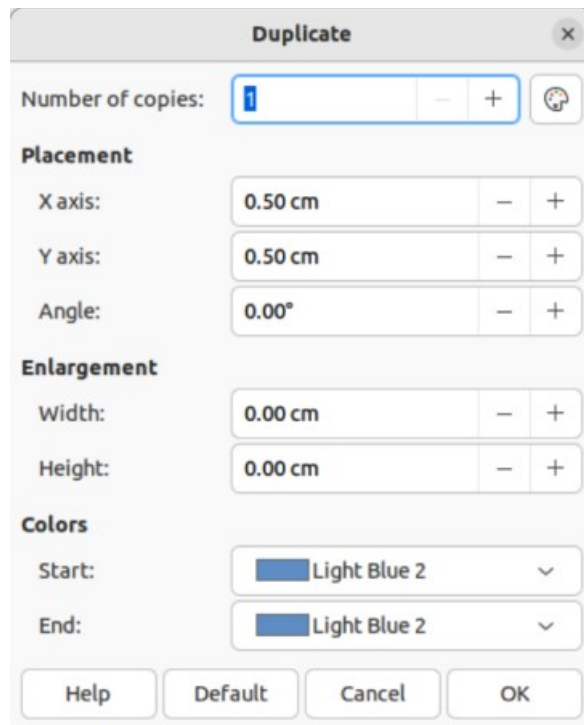

Figure 226: Duplicate dialog

- Go to **Edit > Duplicate** on the Menu bar.
 - Go to **Shape > Duplicate** on the Menu bar.
 - Use the keyboard shortcut *Shift+F3*.
- 2) Select the required options in **Number of copies**, **Placement**, **Enlargement**, and **Colors**.
 - 3) Click **OK** to duplicate the object and close the Duplicate dialog.

Cross-fading

Cross-fading transforms one object shape to another object shape. The result is a new group of objects with the first object selected as the start object and the second object selected as the end object. For example, when the options in the Cross-fading dialog are applied to a rectangle and an oval, the cross-fading produces the result shown by the example in Figure 227.

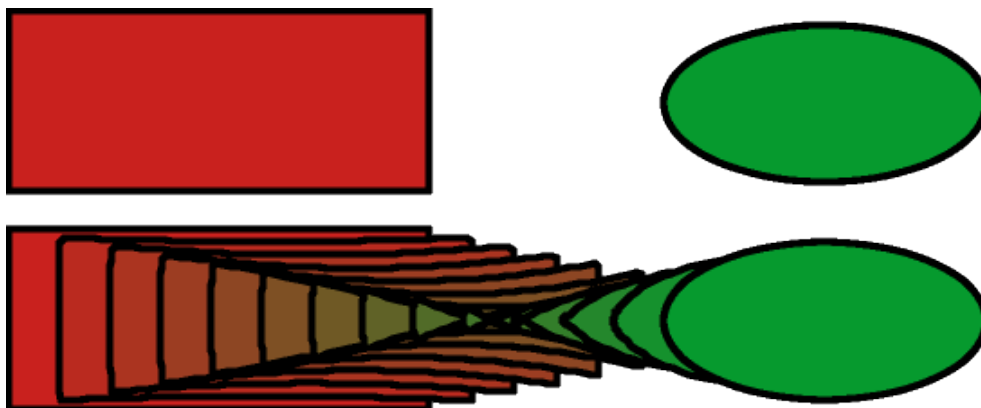

Figure 227: Example of cross fading objects

- 1) Select two differently shaped objects and go to **Shape > Cross-fading** on the Menu bar to open the Cross-fading dialog (Figure 228).

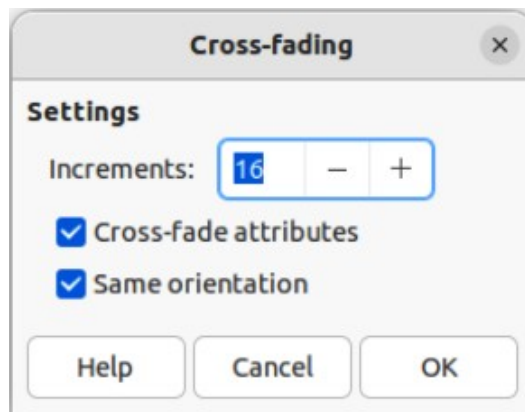

Figure 228: Cross-fading dialog

- 2) In *Increments* enter the number of shapes between the two objects.
- 3) Select *Cross-fading attributes* to apply a gradual change of line and fill properties between the two objects.
- 4) Select *Same orientation* to apply a smooth transition between the two objects.
- 5) Click **OK** to carry out the cross-fading and close the Cross-fading dialog.

Grouping and combining multiple objects

Using Draw, a group of objects can be grouped together allowing multiple objects to be treated as one object, or combined together to create a new shape, as shown by the example (1) in Figure 229. For more information on grouping and combining objects, see the *LibreOffice Draw Guide*.

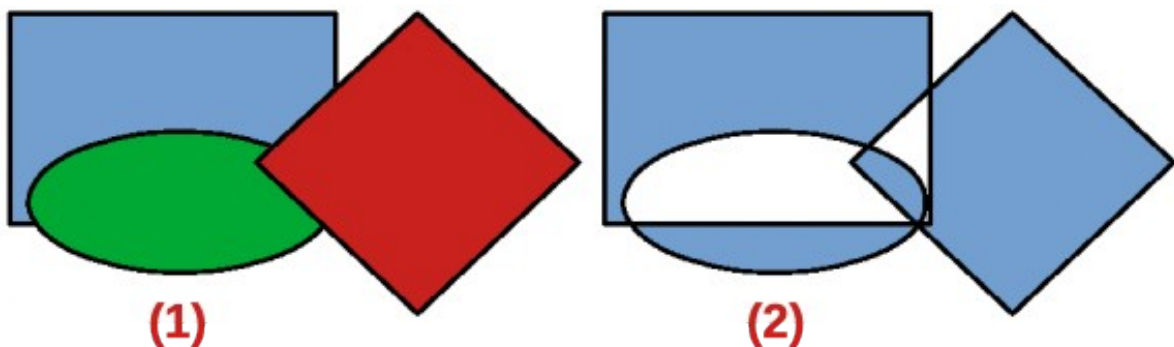

Figure 229: Example of grouping and combining objects

Grouping

Grouping of objects is similar to putting objects into a container. The objects can be moved as a group and global changes applied to the objects within the group. A group can always be undone (ungroup). Objects that make up a group can always be manipulated separately and retain their own individual properties.

Temporary grouping

A temporary grouping is when several objects are selected using one of the following methods:

- While holding down the *Shift* key, click on each object with the cursor to select it for the temporary group.

- Click and drag the cursor to create a rectangle (also known as a marquee) around the objects required for the temporary group.

Any changes to object parameters carried out are applied to all of the objects within the temporary group. For example, rotating a temporary group of objects in its entirety.

To cancel a temporary grouping of objects, click outside of the selection handles displayed around the objects.

Permanent grouping

A permanent grouping of objects can be created after selecting objects using one of the following methods:

- Go to **Shape > Group > Group** on the Menu bar.
- Right-click on the selected objects and select **Group** in the context menu.
- Use the keyboard shortcut *Ctrl+Shift+G* (macOS +*Shift+G*)

When deselected, the objects remain grouped together. Any editing operations carried out on the group are applied to all objects within the group. If one object in the group is clicked, the whole group is selected.

Editing within groups

Editing an individual within a group can be carried out without ungrouping or breaking the group. After selecting the group, use one of the following methods to enter the group:



- Go to **Shape > Group > Enter Group** on the Menu bar.
- Right-click on the selected group and select **Enter Group** in the context menu.
- Use the keyboard shortcut *F3*.
- Double-click on the selected group.

When editing is finished on an individual object within a group, use one of the following methods to exit the group:

- Go to **Shape > Group > Exit Group** on the Menu bar.
- Right-click and select **Exit Group** in the context menu.
- Use the keyboard shortcut *Shift+F3* (macOS +*F3*).

Ungrouping

To ungroup or break apart a permanent group of objects, use one of the following methods:

- Go to **Shape > Group > Ungroup** on the Menu bar.
- Right-click and select **Ungroup** in the context menu.
- Use the keyboard shortcut *Ctrl+Alt+Shift+G* (macOS ++*Shift+G*).

Nesting groups

A group of groups, more commonly known as nested groups, can be created. When nested groups are created, Draw retains the individual group hierarchy and remembers the order in which groups were selected. That is, the last individual group selected will be on top of all the other groups within a nested group. Ungrouping and entering a nested group work in the same way as for individual groups.

Combining objects

Combining is a permanent merging of objects, creating a new object. The original objects are no longer available as individual entities and cannot be edited as individual objects. Any editing of a combined object affects all the objects that were used when combination was carried out. For more information on combining objects, see the *LibreOffice Draw Guide*.

After selecting the objects for combining, use one of the following methods to create a new object. An example of combining objects is shown in Figure 229 (2) on page 310.

- Go to **Shape > Combine** on the Menu bar.
- Right-click on the objects and select **Shapes > Combine** in the context menu.
- Use the keyboard shortcut *Ctrl+Shift+K* (macOS *⌘+Shift+K*).

Merging, subtracting, and intersection

After selecting several objects, the **Merge**, **Subtract**, and **Intersect** functions become available. These functions are similar to combining objects, but allow the creation of a differently shaped object from the selected objects. The shape of the object depends on which function used. See the *LibreOffice Draw Guide* for more information on how to use these functions.

Arranging, aligning, and distributing objects

In LibreOffice Draw, selected objects can be arranged, aligned, and distributed in relation to each other. See the *LibreOffice Draw Guide* for more information on arranging and aligning objects.

- Arrange the position of an object by moving it either forward or backward in relation to the order of objects.
- Align objects with respect to each other using **Left**, **Centered**, or **Right** for horizontal alignment and **Top**, **Center**, or **Bottom** for vertical alignment.
- Distribute objects so that the space between each of the objects is the same.

Inserting and exporting images

Inserting

LibreOffice Draw contains a number of functions for editing images (also called pictures, raster graphics, or bitmaps). These functions include the import and export of images, and conversion from one image format to another. For more information on working with images, see Chapter 5, Working with Images and Graphics in this guide and the *LibreOffice Draw Guide*.

LibreOffice Draw includes a large range of filters so that it can read and display several image file formats. It also includes several tools for working with images, but does not have the same functionality as specialized programs, for example GIMP, or Adobe Photoshop.

Images can be added from several sources:

- Directly from a scanner (**Insert > Media > Scan** on the Menu bar).
- Created by another program, for example photographs from a digital camera (**Insert > Image** on the Menu bar).
- The LibreOffice Gallery; see Chapter 5, Working with Images and Graphics.

Exporting

LibreOffice Draw saves images as drawings in the Open Document Format (odf). To save an image or the entire file in another format, go to **File > Export** on the Menu bar and select a format in the drop-down list. The image formats that LibreOffice Draw can export in and save to are listed in Appendix B, Open Source, Open Standards, OpenDocument.

LibreOffice Draw files can also be exported in HTML, XHTML, or PDF format. The HTML export uses a conversion wizard that creates as many web pages as there are pages in a document. Optionally drawing pages can be displayed in frames with a navigator and an index page. For more information about file formats, see Chapter 10, Working with File Formats, Security, and Exporting.

Working with 3D objects

Although LibreOffice Draw does not match the functionality of specialized drawing, or image editing programs, it is capable of producing and editing good 3D drawings. For more information, see the *LibreOffice Draw Guide*.

Create a 3D object in LibreOffice Draw using one of the following methods:

- Select a 3D shape in the **3D Objects** panel in the Shapes deck on the Sidebar.
- Right-click on a 2D object and select **Convert > To 3D**, or **To 3D Rotation Object** in the context menu.
- Right-click on a 2D object and select **Format > 3D Effects** on the Menu bar.

Working with layers

Using layers when creating complex drawings makes a drawing easier to navigate and edit. Placing a simpler drawing that is part of a complex drawing into its own layer makes editing easier. Any area of a layer that does not contain a drawing object is transparent and does not obscure any part of a complex drawing. Any number of layers can be added to a drawing. For more information on layers, see the *LibreOffice Draw Guide*.

A drawing in LibreOffice contains three default layers that cannot be deleted or renamed:

- **Layout** — is the default Workspace where objects are normally placed when a drawing is created.
- **Controls** — used for form controls that have been assigned an action. Objects on this layer are always in front of objects on other layers.
- **Dimension Lines** — is where the dimension lines are drawn. By switching the layer to show or hide, dimension lines can be switched on or off.

A layer can be set to one or all of the following attributes:

- Visible or hidden.
- Printable or not printable.
- Locked or unlocked.

To quickly toggle the attributes for a selected layer, use the following keyboard shortcuts:

- *Shift+click* — toggle between a layer being visible or hidden.
- *Ctrl+click* (macOS +click) — toggle between a layer being locked or unlocked.

- *Ctrl+Shift+click* (macOS +*Shift+click*) — toggle between a layer being printed or not printed.

Adding layers

- 1) Use one of the following methods to open the Insert Layer dialog (Figure 230):
 - Go to **Insert > Layer** on the Menu bar.
 - Right-click on the layer tabs at the bottom of the Workspace and select **Insert Layer** in the context menu.
- 2) Enter a meaningful **Name**, **Title**, and **Description** for the new layer in the text boxes.
- 3) Select **Visible** if the layer is to be visible in a drawing. When **Visible** is not selected, the layer is hidden and its name in the layer tab changes color to blue.
- 4) Select **Printable** if the layer is to be printed when a drawing is printed. Not printing is useful if a draft layer is required for guides or annotations that are used in making a drawing, but do not appear in the final output. The name of a layer is underlined in the layer tab bar when the **Printable** option is turned off.
- 5) Select **Locked** to prevent any objects on this layer from deletion, editing, or moving. No additional objects can be added to a locked layer. Locking a layer is useful, for example, when a base plan is to be protected while adding a new layer with other details. The name of a locked layer is written in *Italics* in the layer tab bar.
- 6) Click **OK** to create the new layer and close the Insert Layer dialog. A new layer automatically becomes active when added to a drawing.

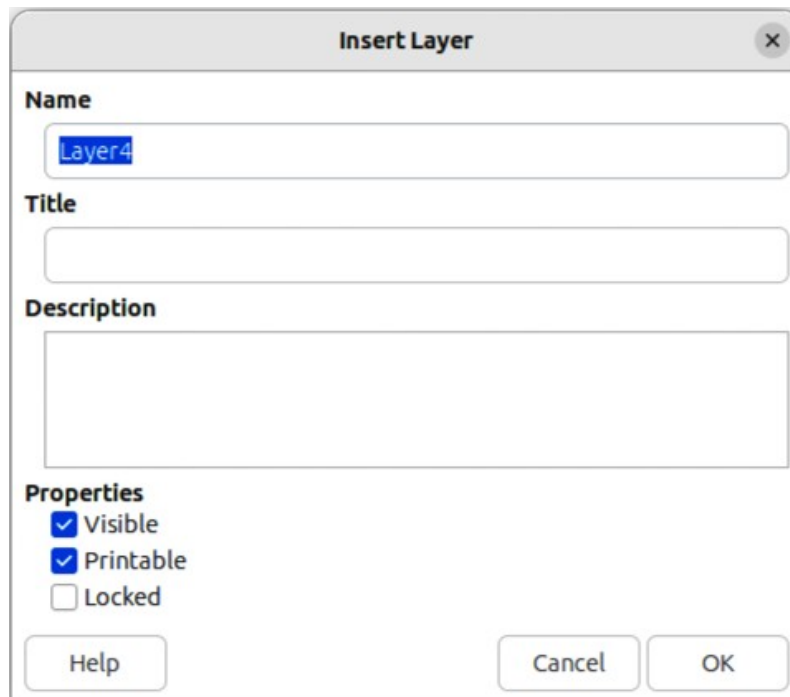

Figure 230: Insert Layer dialog

Note

Layers are added to the drawing in the order that they were inserted. The layer order cannot be changed.

Modifying layers

- 1) To modify a layer, use one of the following methods to open the Modify Layers dialog, which is similar in layout and options to the Insert Layers dialog.
 - Right-click on the name tab of the layer and select **Modify Layer** in the context menu.
 - Double-click on the layer tab.
 - Go to **Format > Layer** on the Menu bar.
- 2) Make the required changes to the layer, then click **OK** to save the changes and close the Modify Layers dialog.

Selecting colors

Colors are selected using a Color palette, the **Area** and **Line** panels on the Properties deck of the Sidebar, and tools on the Line and Filling, and Drawing toolbars.

Note

For a more detailed description of the options available for Color palettes and custom colors, as well as more information on the difference between the CMYK and RGB Color schemes, refer to the *LibreOffice Draw Guide*.

Color palette

The Color Palette allows quick selection of a color for an area, background, or lines of selected objects in a drawing. To display the Color Palette (Figure 231), go to **View > Color Bar** on the Menu bar. To close the Color Palette, go to **View** on the Menu bar and deselect **Color Bar**.

- Left-click on a color to change the area or background color of a selected object.
- Right-click on a color to change the color of lines in a selected object.
- Left-click on the box with the X at the bottom left of the Color Palette to select no color for the area, or background of a selected object.
- Right-click on the box with the X at the bottom left of the Color Palette to select no color for the lines of a selected object.

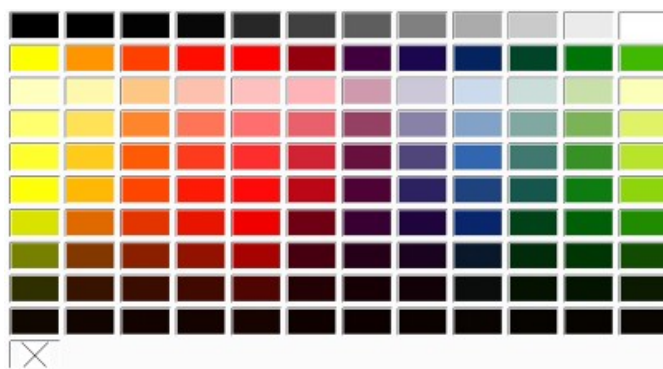

Figure 231: Color Palette (Color Bar)

Sidebar color

In the **Area** and **Line** panels in the Properties deck on the Sidebar (Figure 232), the color of an area or line of a selected object can be changed.

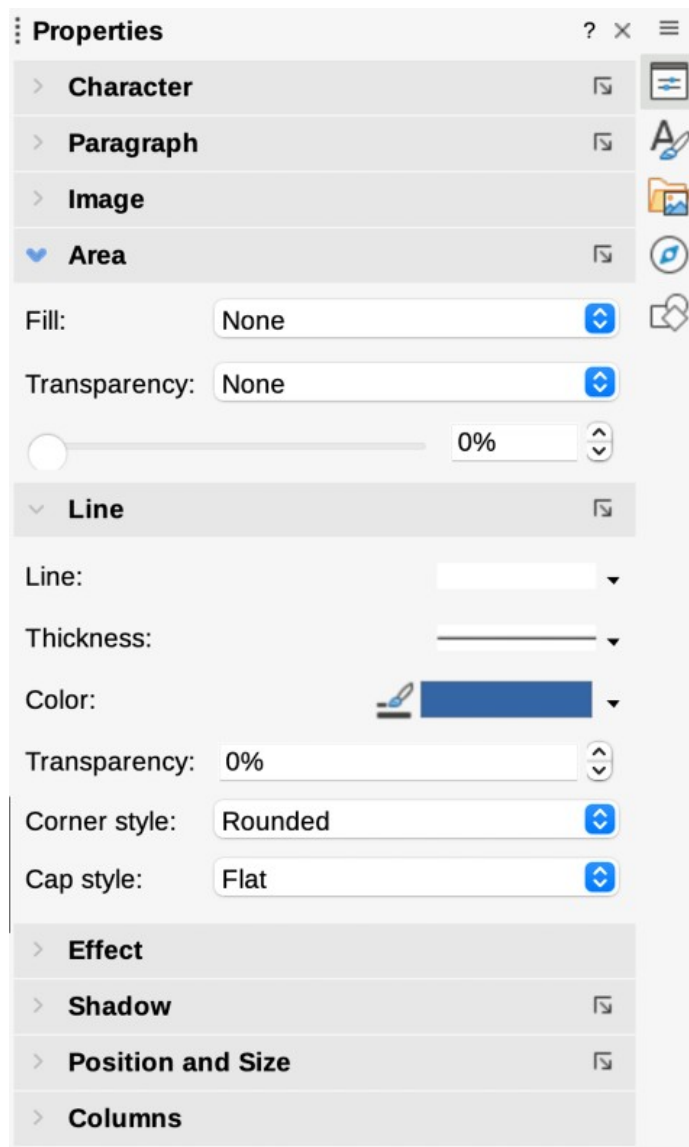

Figure 232: Area and Line panels in Properties deck on Sidebar

- 1) Select an object in a drawing.
- 2) Click on **Properties** on the Sidebar. In the Properties deck, open the **Area** and/or **Line** panels by clicking on the triangle ▼ on the panel title bar.
- 3) Change the color of an area in the **Area** panel as follows:
 - a) Select **Color** in the *Fill* drop-down list.
 - b) Click on the triangle ▼ next to the *Fill Color* box to open a drop-down list of available color palettes.
 - c) Select the required color palette from the options available.
 - d) Click on the required color to change the area color.
- 4) Change the color of a line in the **Line** panel as follows:
 - a) Click on the triangle ▼ next to the *Line Color* box to open a drop-down list of available color palettes.
 - b) Select the required color palette from the options available.
 - c) Click on the required color to change the line color.

Toolbar color change

The Line and Filling, and Drawing toolbars have similar tools that can be used to change the color of an area (fill) or line — **Fill Color** and **Line Color**. These tools are used in a similar way as changing colors using the **Area** and **Line** panels on the Properties deck of the Sidebar.

Adding comments to a drawing

Adding comments to a drawing uses a similar process to the one used in Writer and Calc. For more about adding, navigating, and replying to comments, see Chapter 4, Getting Started with Writer.

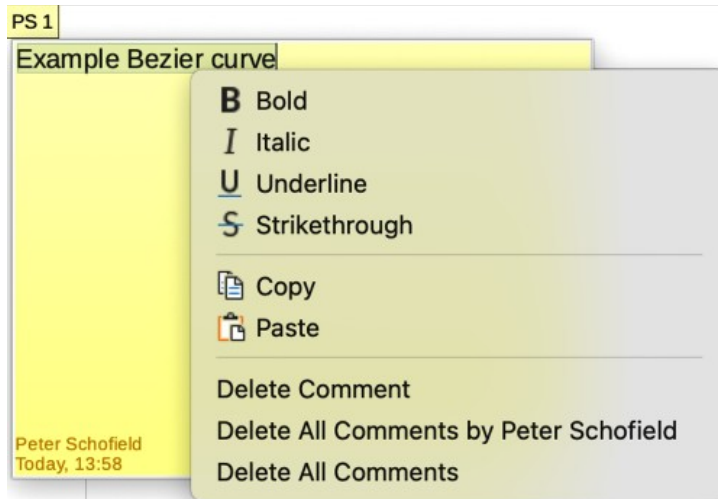

Figure 233: Example of inserting comments

Before using comments, make sure that name and initials are entered into **Tools > Options > LibreOffice > User Data** (macOS **LibreOffice > Preferences > LibreOffice > User Data**). The name and initials then appears in the comment marker and in the author field of the comment.

If more than one person edits the document, each author is automatically allocated a different background color. Go to **View > Comments** on the Menu bar to show or hide the comment markers.

- 1) Go to **Insert > Comment** on the Menu bar. A small box containing the user initials appears in the upper left-hand corner of the drawing with a larger text box beside it (Figure 233). Draw automatically adds the name and the date at the bottom of this text box.
- 2) Type or paste comments into the text box.
- 3) If necessary, click and drag the small comment markers to move the comment to a different position on the drawing. Normally, the comment marker is placed on or near the object referred to in the comment.
- 4) Right-click on the comment and choose an option from the context menu to carrying out the following:
 - Delete the current comment.
 - Delete all the comments from the same author.
 - Delete all the comments in the document.
 - Carry out basic text formatting on the comment.



LibreOffice
Community



Chapter 8, Getting Started with Base

Relational databases in LibreOffice

Introduction

A data source, or database is an organized collection of information that can be accessed or managed by software. When you manage a database in LibreOffice, you will do it through the Base module.

For example, a list of names and addresses could be turned into a database that could help you create a mail merge letter, or a business stock list could be a data source managed through LibreOffice.

Base serves as a database front end that can create and store embedded databases (Figure 234) or connect to external databases (Figure 235).

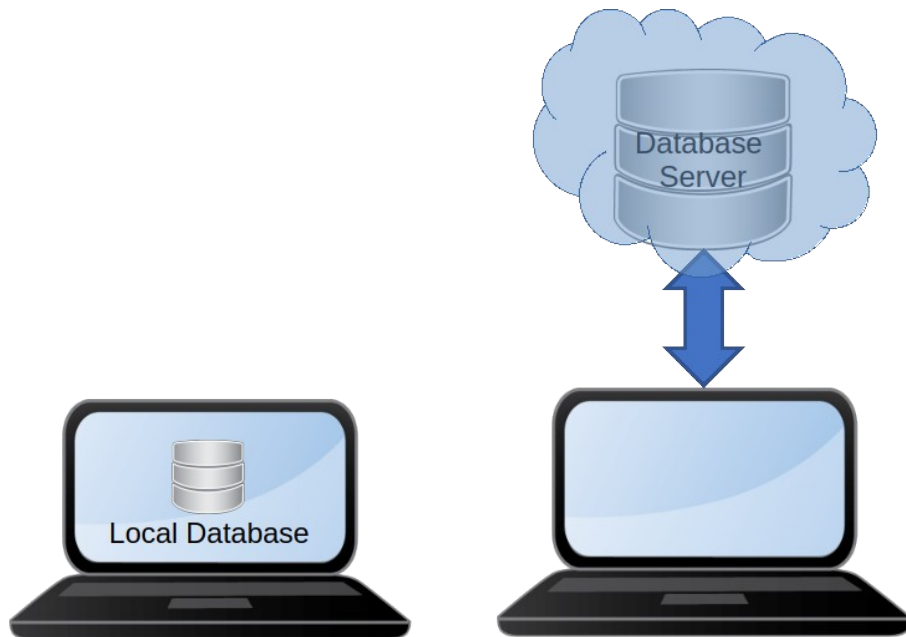

Figure 234: Local database

Figure 235: Remote database server

This chapter explains how Base can create databases and reads what is contained in a database, and it also describes how the different parts of the module are used.

Note

LibreOffice uses the terms “Data Source” and “Database” to refer to the same thing, which could be a database such as MySQL or dBase, a spreadsheet or text document holding data, or an address book.

Database components explained

Tables

A *database* consists of a number of *fields* that contain the individual pieces of data, which in turn can be organized in records and then into *tables*. Unlike Calc spreadsheets, database tables cannot have formulas and when creating a table, you also determine the characteristics of each field within it (text, characters, integer numbers, floating point numbers, binary data, etc...)

Forms

Forms are documents created for data entry into the fields of one or more tables which have been associated with the form. For example, when you enter your data in a web

service, you are using a form. Forms can also be used for viewing fields from one or more tables associated with the form.

Queries

A *query* creates a new table from the existing tables. A query extract data from tables given a specific search criteria you define.

Reports

A *report* organizes the information from the fields of a query or table into a formatted document according to your requirements.

Caution

Some features of the Base module, such as the HSQLDB database engine, and the ability to create reports) need the Java Runtime Environment (JRE). The JRE is not installed in Base by default. Please go to **Tools > Options > LibreOffice > Advanced** to select a JRE from those installed on your computer.

Type of databases in LibreOffice Base

Base can create both flat and relational databases, and it can create databases where fields have relationships with each other.

Flat databases

A flat database is a simple database system in which each database is represented as a single table in which all of the records are stored as single rows of data. The table is usually stored and physically represented as a simple text file, CSV file or spreadsheet.

Relational databases

A relational database (RDB) is a collective set of multiple data sets organized by tables, records and columns (fields). RDBs establish a well-defined relationship between database tables. Tables communicate and share information, which facilitates data searchability, organization and reporting. Base use Structured Query Language (SQL), a standard user application that provides an easy programming interface for database interaction.

For example: Consider a database that lists a CD music collection. It will contain fields for the names of the artists and a field that holds the CD title. While there is an obvious relationship between the artist and the CD they have created, the CD collection may contain more than one CD by the same artist. These are one-to-many relationships: many artists are linked to more than one CD, so this database contains multiple one-to-many relationships. However, the record company database can contain the names of the artist plus other fields like artist agent. The relationship between artist and agent is one to one: only one agent for each artist.

Tip

If you are acquainted with mathematical sets, a relational database can easily be explained in terms of sets: *elements*, *subsets*, *unions*, and *intersections*. The fields of a database are the elements and the tables are subsets. Relationships within databases are defined in terms of unions and intersections of the subsets (tables).

Planning a database

Databases exist to organize data for easy and accurate retrieval. Database tables are much stricter to define and create, therefore planning in advance is necessary. In this chapter, we will

show you how to plan a database. In our example, we will create a database that contains automobile expenses.

The first step in creating a database is to define it by determining what fields are needed. In this case, we will ask a series of questions about the data:

What are the user output requirements?

Information is needed on three broad areas: fuel usage, maintenance, and vacation.

What input data is required for the output?

Fuel purchases, maintenance expenses, and vacation expenses.

What fields fit the fuel purchases area?

Date purchased, odometer reading, fuel cost, fuel quantity, and payment method for it. (Fuel economy need not be included, as it can be calculated using a query.)

What fields fit the maintenance area?

Date of service, odometer reading, type of service, cost of service, and next scheduled service of this type (for example, for oil changes, list when the next oil change should be). A field for notes was added to the list.

What fields fit the vacations area?

Date, odometer reading, fuel (including all the fields of the fuel table), food (including meals and snacks), motel, total tolls, and miscellaneous. These purchases are made by one of two bank cards or cash, so we will need a field to state which payment type was used for each item.

What fields fit into the food category?

Breakfast, lunch, supper, and snacks seem to fit. Should all the snacks be listed individually or list the total cost for snacks for the day? In this case, the snacks are divided into two fields: number of snacks and total cost of snacks, and a payment type is also needed for breakfast, lunch, supper, and total cost of snacks.

What are the fields that are common to more than one area?

Date appears in multiple areas, as does odometer reading and payment type.

How will these fields be used to get the required information?

While on vacation, the expenses for each day will be listed together. These date fields suggest a relationship between the vacation table and the dates in the fuel and food tables, so the date fields in these tables will be linked when the database is created.

These payment type will include two bank cards and cash. So a table will be created with a field for the type of payment and use it in list boxes in the forms.

 **Tip**

After the fields for the database tables have been listed, we will need a field for the *primary key*, which is an identifier that is unique to each record. Some of the tables already have a suitable field for the primary key but an additional field for the primary key must be created for other fields (like payment type).

If a table does not have a primary key field, any data that is added, deleted, or modified must be done with the Execute SQL Statement dialog (**Tools > SQL...**).

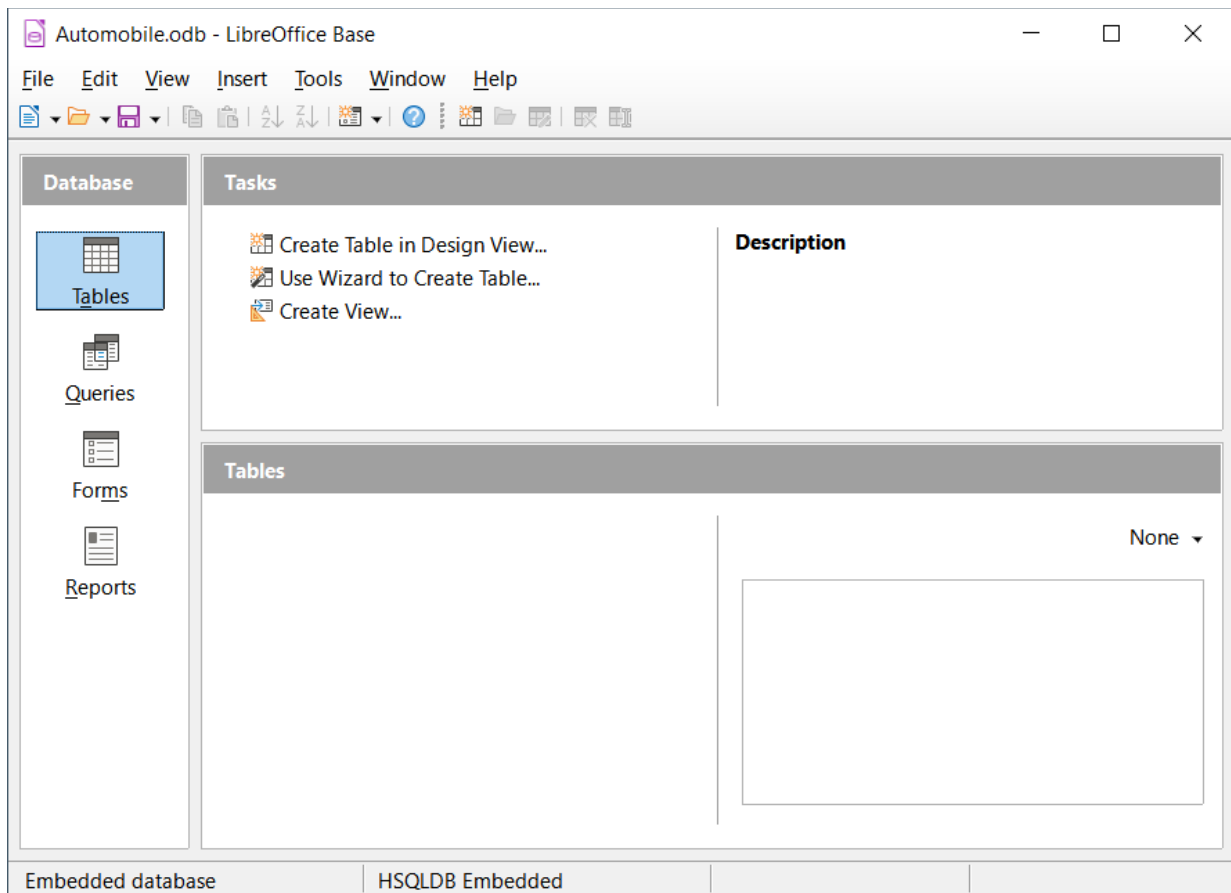

Figure 236: LibreOffice Base window

Using the Database Wizard to create a new database

To create a new database, you should start with the Database Wizard. The wizard can be started by doing one of the following:

- Selecting **File > New > Database** on the Menu bar
- Clicking the arrow next to the **New** icon on the Standard toolbar and selecting **Database** in the drop-down menu.
- Clicking the **Base Database** button in the *Create* area of the LibreOffice Start Center.
- If you are already working in Base, you can also press *Ctrl+N*.

Once the Wizard is started, the first page of the wizard appears (Figure 237). Select the **HSQLDB Embedded** entry is selected in the *Embedded database* drop-down menu, select **Create a new database**, then click **Next**. (Look at the *Base Guide* for information about using alternative embedded database engines or existing external databases).

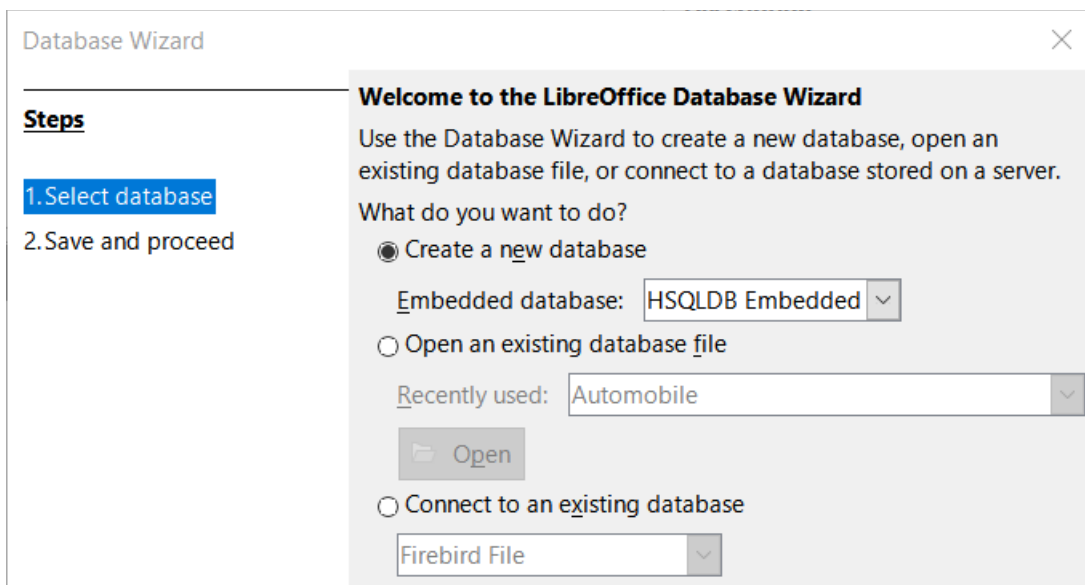

Figure 237: Creating a new database

Next, the second page of the Database Wizard appears (Figure 238) with two questions. For the first question, make sure the database is registered. And for the second question, click the **Open the database for editing checkbox**. Click **Finish**. The Database Wizard will prompt you to select a location to name and save the database.

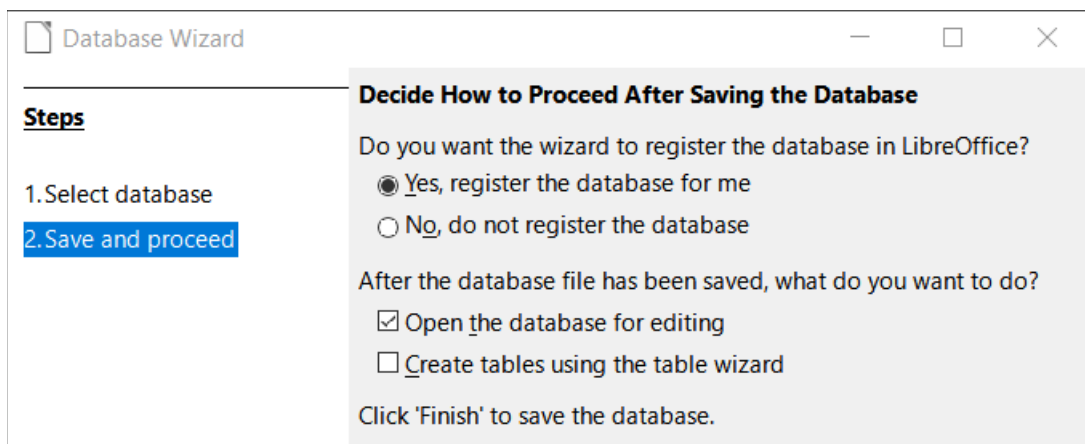

Figure 238: Registering the new database

Note

To open and close the Data Sources window that contains the list of registered databases Writer and Calc, select **View > Data Sources** or press *Ctrl+Shift+F4*. If a database is not registered, they will not appear in this window. and you cannot access it in Writer or Calc if you need to use data from it.

Save this new database with the name Automobile and the Automobile.odt – LibreOffice Base window appears (Figure 236).

Tip

Every time the Automobile database is opened, the Automobile.odt – LibreOffice Base window opens. Changes can then be made to the database. The title for this window is always <database name> – LibreOffice Base.

Caution

When you create a database, you should save your work regularly. This means you should save the whole database as well.

For example, when you create your first table, you must save it before you can close it. This makes it part of the database in memory. But only when you save the database file that the table is written to disk.

Note

All database files in Open Document Format are stored with the *.odb extension. Files in that format contain all elements of the database, including forms, reports, tables, and the data itself. The same format can also store a connection to an external database server instead of the local data, for example, to access a MySQL or PostgreSQL database server in your network.

Creating database tables

Database tables store information in a group of things called fields. For example, a table will use fields to hold the data in an address book, a stock list, a phone book, or a price list. A database must have at least one table and will probably have multiple tables.

Each field can hold data of a single type. For example, an address book that contains phone numbers would contain phone numbers in fields that are the Phone type. Similarly, a price list table might contain two fields: Name and Price. The Name field would contain the names of the items; the Price field would contain the amount of each item.

To work with tables, click the **Tables** icon in the *Database* list, select **View > Tables**, or press **Alt+A**. The tasks that you can perform on a table are in the *Tasks* list (see Figure 325).

Using the Table Wizard to create a table

This Base wizard allows you to create two types of tables: business and personal. Each category contains sample tables from which to choose. Each table has a list of available fields.

The Table Wizard provides sample tables as a starting point to create your own table.

Click **Use Wizard to Create Table**. This opens the Table Wizard (Figure 240).

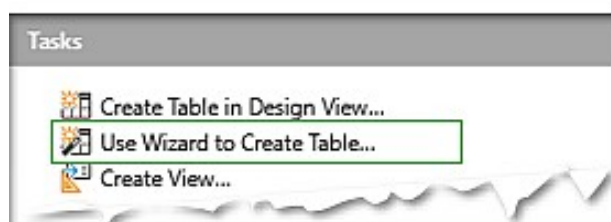

Figure 239: Creating a table using Wizard

Step 1: Select fields

First, we will use the wizard to generate a table in the Personal category. We will borrow a table from the supplied CD-Collection:

- 1) *Category*: Select **Personal** and a list of sample tables for personal use appears.
- 2) *Sample tables*: Select **CD-Collection** and a list of available fields appears in the Selected fields window..

- 3) *Selected fields*: By selecting each field and using the > button, move the following fields from the *Available fields* list to the *Selected fields* list: CollectionID, AlbumTitle, Artist, DatePurchased, Format, Notes, and NumberofTracks.

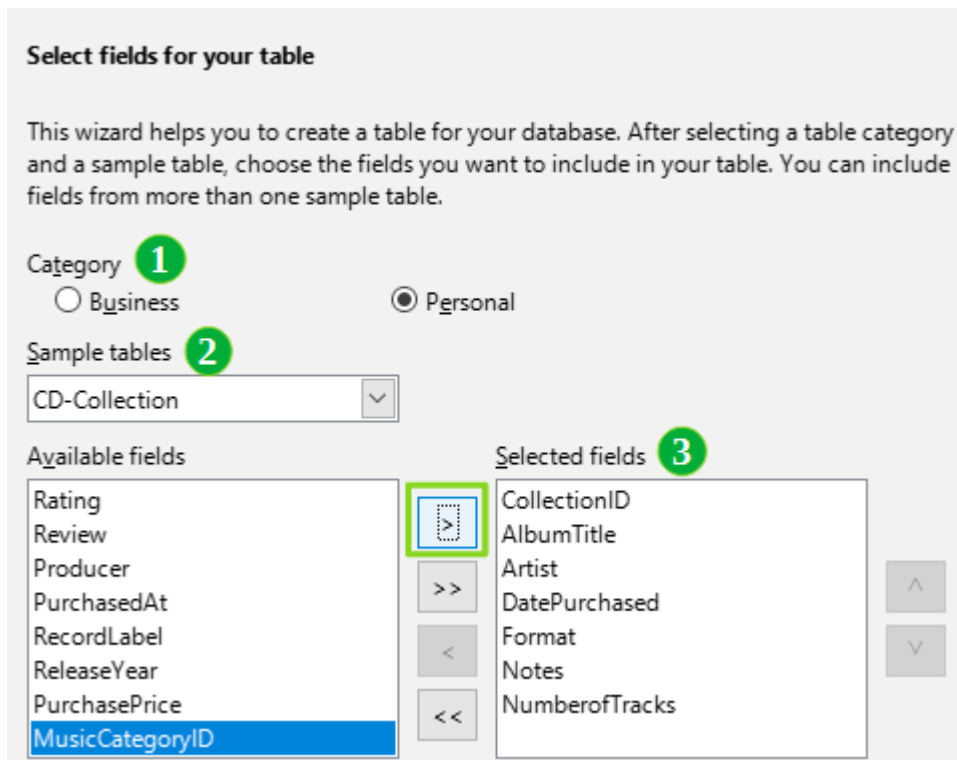

Figure 240: Selecting fields from the Personal category

Next, we will use the wizard to create a table from the Business category:

- 1) *Category*: Select **Business** as the Category. Select **Employees** in the drop-down list of sample tables.

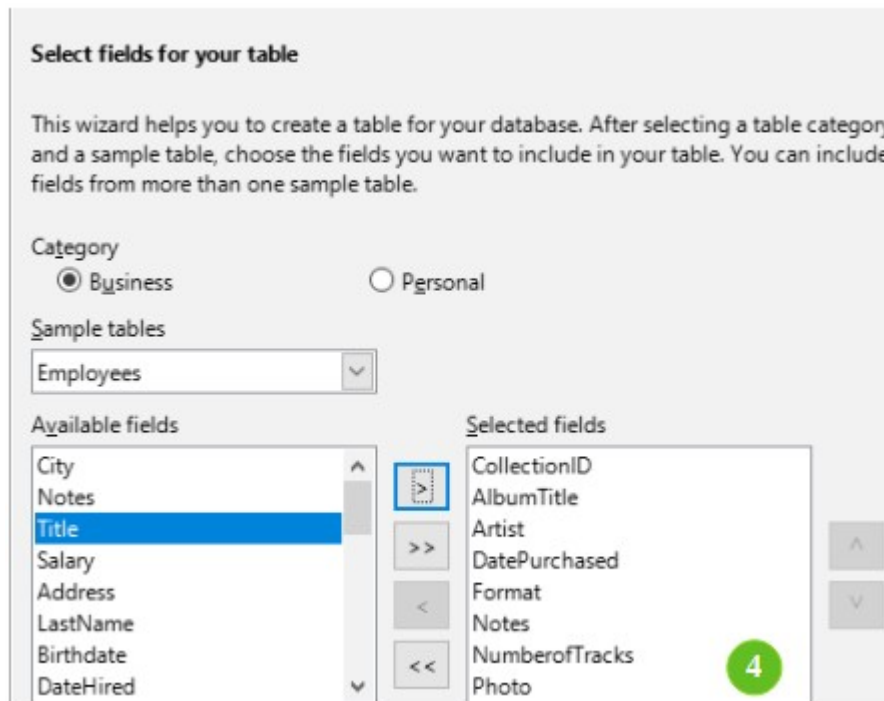

Figure 241: Selecting fields for the table

- 2) Use the > button to move the Photo field from the *Available fields* list to the *Selected fields* list. It will be at the bottom of the list, directly below the NumberofTracks field. If you make a mistake in selecting fields, click on the field name in the *Selected fields* list and use the < button to move it from the *Selected fields* list back to the *Available fields* list.
- 3) If necessary, click the field name and use the up and down arrows on the right side of the *Selected fields* list to move it to the correct position.
- 4) Click **Next**.



Tip

You can double-click on a field to transfer it from the *Available fields* list to the *Selected fields* list or double-click a field in the *Selected fields* list to transfer it back to the *Available fields* list.

Step 2: Set field types and formats

Once the wizard has helped you to select the fields for your database, it will allow you to assign properties to each field. (See Figure 243.) In this example, set each field's properties as follows:



Note

If any of these fields requires a mandatory entry, set *Entry required* to **Yes**. A blank field will then not be allowed. By default, the *Entry required* property is set to **No**. (Because *AutoValue* has been set to **Yes**. Figure 243 does not display the *Entry required* field.)

- **CollectionID**: Since this field must be filled, change *AutoValue* from **No** to **Yes**.
- **AlbumTitle**:
 - *Entry required*: If all of your music is in album format, set *Entry required* as **Yes**. If not, set this property to **No**.
 - *Length*: Do not change this property unless you have titles that exceed 100 characters counting the spaces.
- **Artist**: Set *Entry Required* to **Yes** unless you do not always use this field.
- **Date Purchased**: *Field type*: default setting. In this case, *Entry required* should be **No** unless you want to add this information to all database entries.
- **Format**: Change the *Entry Required* setting from **No** to **Yes**.
- **Notes**: No changes are required.
- **NumberofTracks**: Change the *Field type* to **Small Integer [SMALLINT]**, which allows for 32768 tracks.
- **Photo**: Use the default settings.



Note

Since Base requires you to specify the maximum length of each field on creation, make sure you make each field as large or maybe larger than necessary. By default, Base uses the VARCHAR format for a text field, so it will only use the number of characters necessary for the field even if it takes up less space than the limit. So when a field uses VARCHAR, a field that contains 20 characters will only take up 20 characters in the database, even if the limit for the field is set at 100. In contrast, a text field with the CHAR text format has a fixed length and that field will be 100 characters long even if the actual length is 1 or 100.

Note

Each field has a *Field type*, which must be specified. Types include text, integer, date, and decimal. If the field is going to have general information in it (for example, a name or a description), use text. If the field will always contain a number (for example, a price), the type should be decimal or another numerical field. The wizard picks the right field type, so to get an idea of how this works, see what the wizard has chosen for different fields.

Tip

Since up and down arrows are available on this page (not shown in Figure 243), you can use these to reorder the list of fields. Also + and – buttons are available and you can use these to remove fields from the list or to add new fields.

When you have finished, click **Next**.

Step 3: Set primary key

- 1) In this example, **Create a primary key** should be checked.
- 2) Next, select option **Use an existing field as a primary key**.
- 3) In the *Fieldname* drop-down list, select **CollectionID**.
- 4) Select **Auto value** if it is not already checked. Click **Next**.

Note

A primary key field contains a unique number that can be used to identify a specific entry in a database. In this case, CollectionID will contain a number that is assigned automatically by Base to each record of this table.

Step 4: Create table

- 1) At this point, the wizard will allow you to rename the table. For this example, make no changes.
- 2) Leave the option **Insert data immediately** checked.
- 3) Click **Finish** to complete the Table Wizard. Close the Table Data View window created by the Table Wizard. You are now back to the main window of the database, but a table named CD-Collection is now listed in the *Tables* portion of the window.
- 4) Click the **Save** button on the Standard toolbar at the top of the main window.

Creating a table by copying an existing table

If you want to create identical tables for each type of music you have, you can make copies of the original table and name each according to the type of music contained in it.

- 1) Click on the **Tables** icon in the Database area of the LibreOffice Base window to see the existing tables.
- 2) Right-click on the **CD-Collection** table icon. Choose **Copy** in the context menu.
- 3) Right-click, and select **Paste**. The Copy table dialog opens.
- 4) Change the Table *name* to *CD-Jazz*, and set *Options* to *Definition and data* and click **Create**.

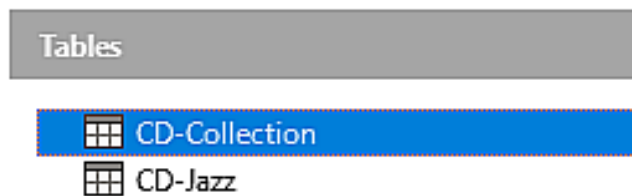

Figure 242: Creating copies of original table

Tip

The action buttons on this page allow you to move selected fields, or all fields, in either direction. You can also double-click to move a field from one list to the other.

5) Click the **Save** button on the Standard toolbar at the top of the LibreOffice Base window.

Caution

After a table has been created in Base and data has been entered, the field properties cannot be changed. Before you create a table, make sure you have decided the correct names, length, and format for each field.

As a result, deleting a field deletes **all the data** once contained in that field. Changing the field type of a field after the table has been created can lead to data being lost either partially or completely.

Deleting a table removes all of the data contained in every field of the table. As a result, do not delete a table unless you are certain.

6) Double-click on the CD-Jazz table icon and visually verify the data before closing the table

7) Right-click on the CD-Jazz table icon, select Delete and confirm deletion.

Creating Tables in Design View

Once you are familiar with creating a table with the Wizard, use Design View to create a new table. View allows you to directly enter information about each field in a table. We will use this method for the next example (the Automobile database).

Note

While the field types and formatting are different in Design View, the process is similar to the one used in the Table Wizard.

When we create the Automobile database, the first table we will generate is **Fuel**. Its fields will be FuelID, Date, FuelCost, FuelQuantity, Odometer, and PaymentType.

1) Find the *Tasks* area of the LibreOffice Base window and click **Create Table in Design View** to open LibreOffice's Base: Table Design dialog.

2) Enter *FuelID* into the *Field Name* field then press *Tab* key to move to the *Field Type* column. Select **Integer [INTEGER]** from its drop-down field.

Tip

You can select fields from the Field Type drop-down list by pressing the key for the first letter of the choice. You can cycle through the choices for a given letter by repeatedly pressing that key.

- d) Change the *Field Properties* in the bottom section of the dialog for *FuelID*. Change *AutoValue* from **No** to **Yes**.
- e) Set *FuelID* as the primary key for the Automobile database. Click in the *Field Name* cell directly below *FuelID*. The dialog automatically sets *FuelID* as the primary key and places a key icon in front of *FuelID* (Figure 244)

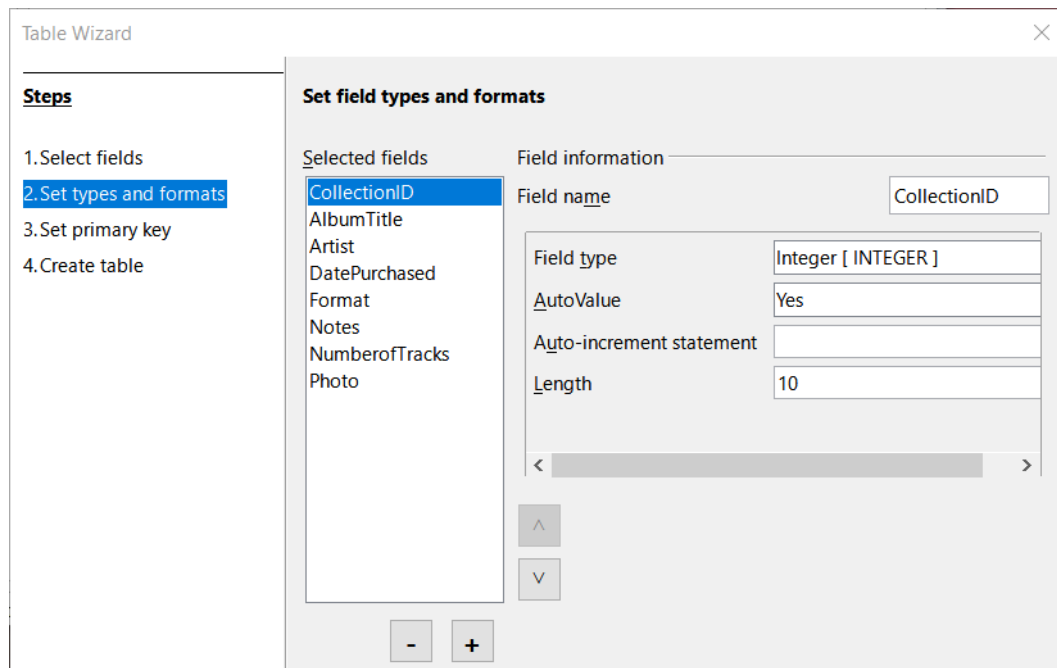

Figure 243: Changing field types

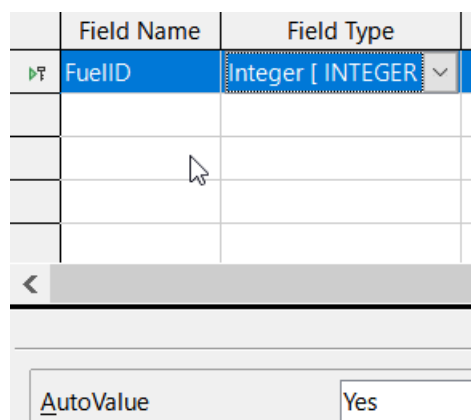

Figure 244: Defining the primary key field

Tip

When you assign certain integer field types (Integer and BigInt for example) to a field, selecting **Yes** for *AutoValue* automatically makes that field the primary key.

Primary keys for any other field type must be selected by right-clicking the rectangle before the field and selecting **Primary Key** in the context menu.

Note

The primary key serves as a unique ID for each record in a database. You can use any name for this field. We have used *FuelID* for convenience, so we know to what function it serves.

- 3) When you are creating the Date, FuelCost, FuelQuantity, Odometer, and PaymentType fields, do the following:
- a) Type the field name in the *Field Name* column.
 - b) Select the field type:
 - For *Date* use **Date[DATE]**. (Press the *D* key to select it.)
 - *FuelCost*, *FuelQuantity*, and *Odometer* use **Number [NUMERIC]**. (Press the *N* key once to select it.)
 - *PaymentType* uses **Text [VARCHAR]**, the default setting.
 - c) *FuelCost*, *FuelQuantity*, and *Odometer* also need changes in the *Field Properties* section (Figure 245).
 - *FuelCost*: Change the *Length* to 5 and *Decimal places* to 2. Click *Format Field* (Figure 245). This opens the Field Format dialog (Figure 246). Use **Currency** as the *Category* and your currency as the *Format*.

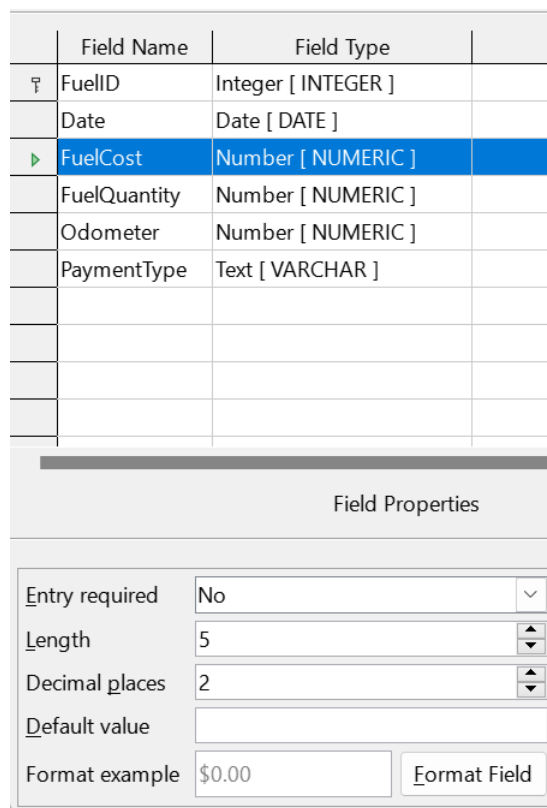

Figure 245: Changing field properties

- *FuelQuantity*: Change *Length* to 6 and *Decimal places* to 3. (Many fuel pumps measure fuel to thousandths of a gallon in the USA.)
 - *Odometer*: Change the *Length* to 10 and the *Decimal places* to 1.
- d) Repeat steps a) through c) until you have entered all of the fields.

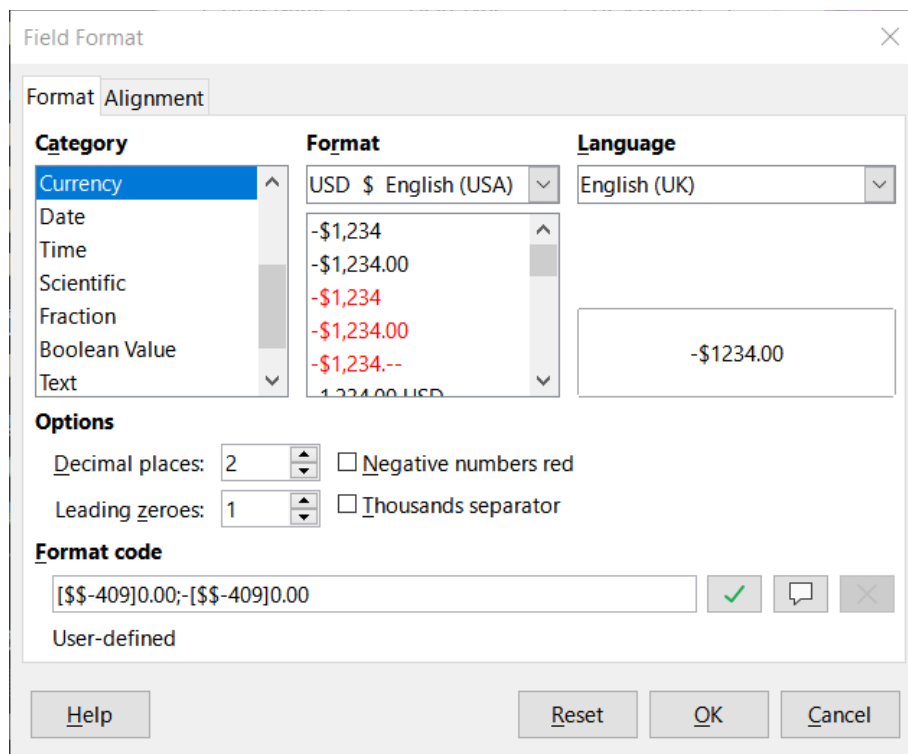

Figure 246: Format example options

- 4) To save and close the table in the Table Design dialog, select **File > Save**, or click the **Save** icon on the Standard toolbar, or press *Ctrl+S*. Name the table *Fuel*.
- 5) Close the Table Design dialog.
- 6) In the main database window, select **File > Save**, click the **Save** icon on the Standard toolbar, or *Ctrl+S* to save the database.

Follow the same steps to create the *Vacations* table. The fields, field types, and descriptions are listed in Figure 247.

- 7) Make the following changes in the *Field Properties* area of the window.
 - a) *Odometer*: As described in step 3)), bullet c)) for the corresponding field of the *Fuel* table.
 - b) *Motel*, *Tolls*, *Breakfast*, *Lunch*, *Supper*, *SnCost*, and *Miscellaneous*: Format currency the same as step 3)), bullet c)) for the *FuelCost* field of the *Fuel* table.
- 8) Making *Date* the primary key in this table has to be done in a different way because this field is typed as *Date*, not *Integer*.
 - a) Right-click to the left of the field name *Date*.
 - b) Select **Primary Key** in the context menu.

Following similar steps to those above, you should use Design View to create a much simpler table entitled *Payment Type*. This table contains two fields, named *Type*, with the field type set to **Text [VARCHAR]** and *PaymentID* (field type **Integer [INTEGER]**). Set the *PaymentID* field as the primary key for the table.

	Field Name	Field Type	Description
¶	Date	Date [DATE]	
	Odometer	Number [NUMERIC]	Odometer reading
	Motel	Number [NUMERIC]	
	Tolls	Number [NUMERIC]	Total tolls
	Breakfast	Number [NUMERIC]	
	BPayment	Text [VARCHAR]	Payment type for breakfast
	Lunch	Number [NUMERIC]	
	LPayment	Text [VARCHAR]	Payment type for lunch
	Supper	Number [NUMERIC]	
	SPayment	Text [VARCHAR]	Payment type for supper
	SnackNo	Number [NUMERIC]	
	SnCost	Number [NUMERIC]	
	SnPayment	Text [VARCHAR]	Payment type for snacks
	Miscellaneous	Number [NUMERIC]	Misc. costs
	MPayment	Text [VARCHAR]	Payment type for motel
	Notes	Memo [LONGVARCHAR]	
▶	MiscPayment	Text [VARCHAR]	Payment type for misc.

Figure 247: Fields in Vacations table

Defining relationships

Now that the tables have been created for the Automobile database, what are the relationships between these database tables?

When on vacation, you will want to enter all of your expenses at once each day. Most of these expenses are in the Vacations table, but the fuel we buy is not. So we will link these two tables using the Date fields. Since the Fuel table may have more than one entry per date, this relationship between the Vacations and Fuel tables is one to many (it is designated 1:n).

- 1) Make sure you are still in the Automobile database and select **Tools > Relationships**. The Automobile – LibreOffice Base: Relation Design window opens and the Add Tables dialog pops up. (You can also open it by clicking the **Add Tables** icon on the Relation Design window if you ever need to do so.)

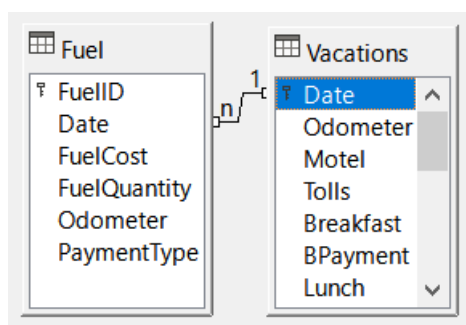

Figure 248: Designation for a 1:n relationship

- 2) Once the Add Tables dialog is active, use one of two ways to add a table to the Relation Design window:
 - Double-click the name of the table. In our case, do this for both *Vacations* and *Fuel*.

- Or, for each table, click the name of the table and then click **Add**.
- 3) When you have added the tables you want, click **Close** to close the Add Tables dialog.
 - 4) Next, define the relationship between the Vacations and Fuel tables by clicking the **New Relation** icon on the Standard toolbar or selecting the **Insert > New Relation** command. Either command opens the Relations dialog (Figure 249). Our two tables are listed in the *Tables Involved* section.

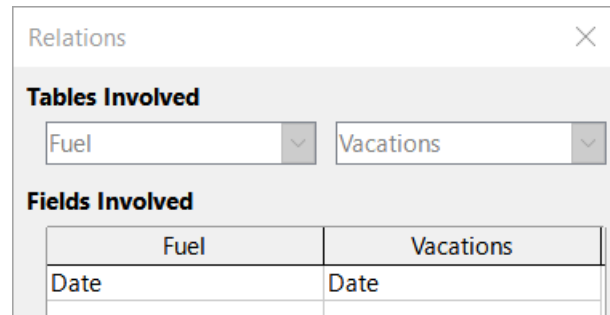

Figure 249: Selected fields in a relationship

- a) In the *Fields Involved* section, click the drop-down list under the *Fuel* label.
- b) Select **Date** in the list.
- c) Click in the cell to the right of this drop-down list. This opens a drop-down list for the *Vacations* table.
- d) Select **Date** in the list. It should now look like Figure 249.
- e) Modify the *Update Options* and *Delete Options* section of the Relations dialog (Figure 250).

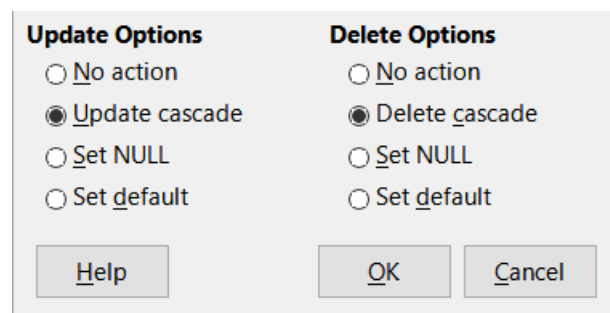

Figure 250: Update Options and Delete Options section

- Select **Update cascade** in the *Update* options area.
 - Select **Delete cascade** in the *Delete* options area.
- f) Click **OK**.
 - g) In the Relation Design dialog, click the **Save** icon or select **File > Save**.
 - h) Close the Relation Design dialog.
 - i) Click the **Save** button on the Standard toolbar at the top of the main database window.



Tip

The primary key can contain more than one field. (Its foreign key¹ will contain the same number of fields.) If this were the case in Figure 249, the other fields of the

1 A field in a table that stores values of the primary key of records in another table.

primary field for the *Fuel* table would be listed under *Date*. The corresponding fields of the foreign key would be listed under *Vacations*. Detailed information about this is in the *Base Guide*.

While these options are not strictly necessary, they do help. Having them selected permits you to update a table that has a relationship defined with another table which has been modified. It also permits you to delete a field from the table without causing inconsistencies.

Creating a database form

Once you have created a database to store data, you will need a form. In the language of databases, a form is a front end for data entry and editing.

A simple form should include all of the fields from a table (Figure 251). More complex forms can contain much more, including additional text, graphics, selection boxes, and many other elements. Figure 252 is made from the same table with a text label (Fuel Purchases), a list box placed in PaymentType, and a graphic background.

Tip

A list box is useful when a field contains a fixed number of options. It saves you from having to type data by hand and having to double-check that the entered data is correct, and ensures that invalid options are not entered.

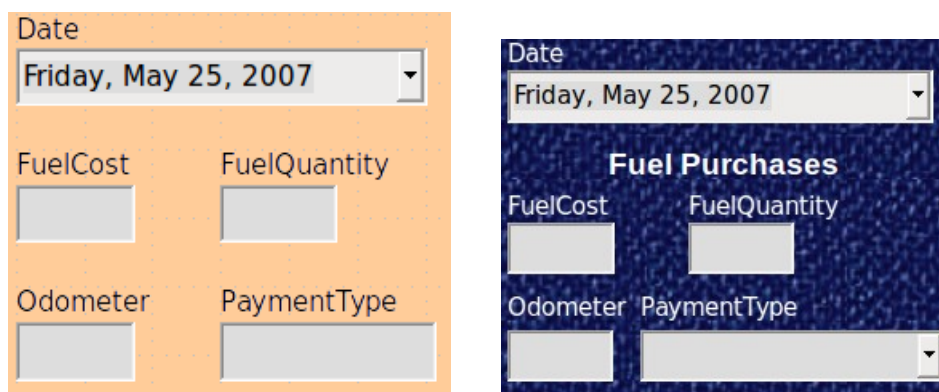

Figure 251: Fields of a simple form Figure 252: Simple form with additions

In our database, payments for food or fuel might be made from one of two credit cards (Dan or Kevin) or in cash, so these would be the available options for all boxes that contain payments.

Note

To create a list box as in Figure 252, we first need to create a small, separate table containing the name of the options. Then use the contents of the table to fill the list box. See *Modifying a form* below

Creating a form with the Form Wizard

We will use the Form Wizard to create a *Vacations* form, which will contain a form and a subform.

In the main database window (Figure 236), activate the Form Wizard by clicking the **Forms** icon in the *Database* area, selecting **View > Forms**, or pressing *Alt+M*. You can also click **Use Wizard to Create Form** on the Tasks list to open the Form Wizard (Figure 253). When the Form Wizard is activated, it displays the Database Form window and the Form Wizard dialog.

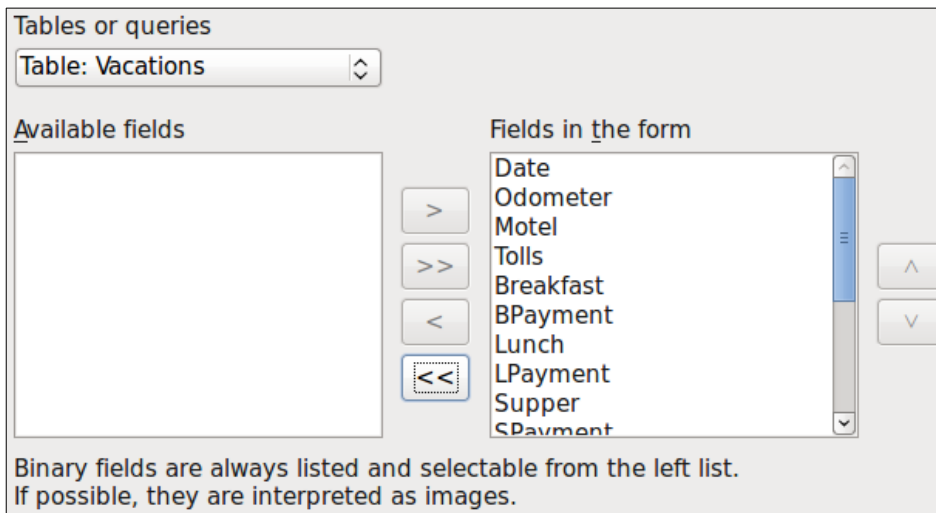

Figure 253: Selecting fields in the Form Wizard

Step 1: Select fields

- 1) On the Form Wizard dialog, under *Tables or queries* drop-down, select **Table: Vacations**. The *Available fields* list contains the fields for the Vacations table.
- 2) Move all of these fields to the *Fields in the form* list by selecting each field and clicking the **>>** button. Click **Next**.



Tip

Using the four action buttons in the center of this page, you can move selected fields, or all fields, in either direction. You can also double-click to move a field from one list to the other. The up and down arrows on the right can be used to re-order entries in the *Fields in the form* list.

Step 2: Set up a subform

Since we have already created a relationship between the Fuel and Vacations tables, we will use that relationship. If no relationship had been defined, you would have to do it later in the wizard (Step 4: Get joined fields).

- 1) Click the box labeled **Add Subform**.
- 2) Click the **Subform based upon existing relation** radio buttons.
- 3) Fuel is listed as a relation we want to add. So click **Fuel** to highlight it, as in Figure 254. Click **Next**.

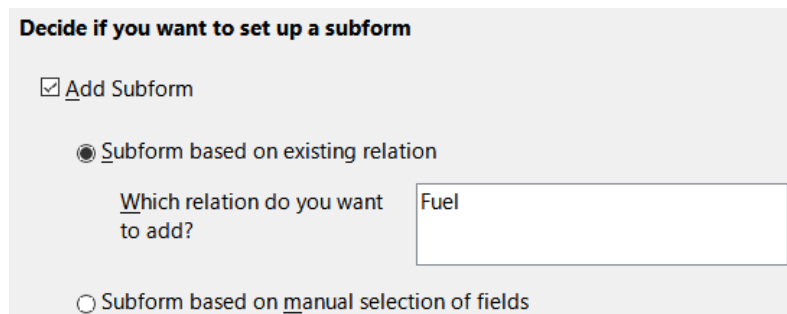

Figure 254: Adding a subform

Step 3: Add subform fields

This step is similar to Step 1: Select fields, but not all the fields will be used in the subform.

- 1) Fuel is preselected under *Tables or queries*.
- 2) Use the >> button to move all the fields to the *Fields in the form* list.
- 3) Click the **FuelID** field to highlight it.
- 4) Use the < button to move the **FuelID** back to the *Available* fields list (Figure 255).
- 5) Click **Next**.

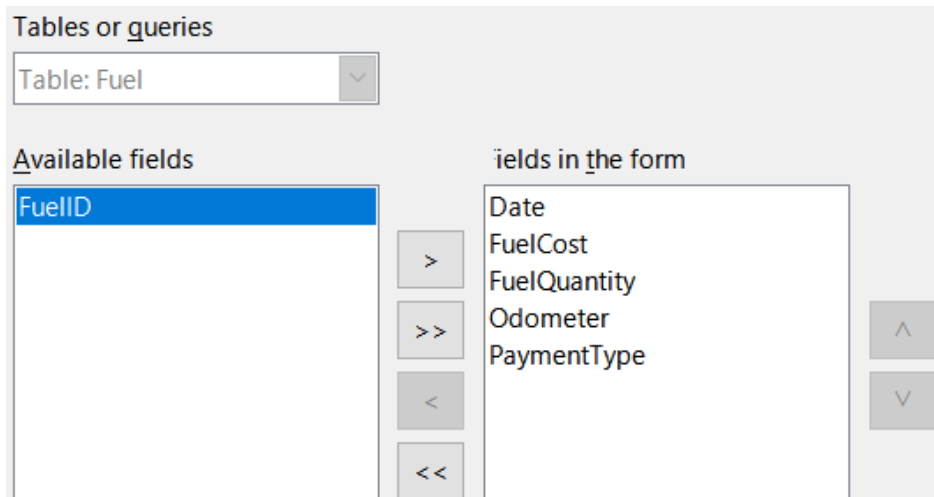

Figure 255: Selecting fields for a subform

Step 4: Get joined fields

This step is for tables or queries for which no relationship has been defined. Because the relationship has been defined in this example, the wizard will skip this step.

Note

Relationships between two tables can be based upon more than one pair of fields. For more information on this, consult the *Base Guide*.

Caution

When creating a relationship between fields from two tables, those fields have to have the same field type. That is why we used the Date field from both tables: both their field types are Date [DATE].

Whether a single pair of fields from two tables are chosen as the relationship, or two or more pairs are chosen, certain requirements must be met for the form to work.

- One of the fields from the main form must be the primary key for its table. (Date would have to be used.)
- No field from the subform can be the primary key for its table. (*FuelID* cannot be used.)
- Each pair of joined fields must have the same field type.

Step 5: Arrange controls

A form's control consists of two parts: label and field. In this step, you determine where a control's label and field are placed relative to each other. From left to right, you can choose *Columnar – Labels Left*, *Columnar – Labels on Top*, *As Data Sheet*, and *In Blocks – Labels Above*.

- 1) *In this example, we will arrange the main form by clicking the second icon (Columnar – Labels on Top). The labels will be placed above the related field.*
- 2) *Next, we will arrange the subform by clicking the third icon (As Data Sheet). The labels are column headings and the field entries are in spreadsheet format. Click **Next**.*

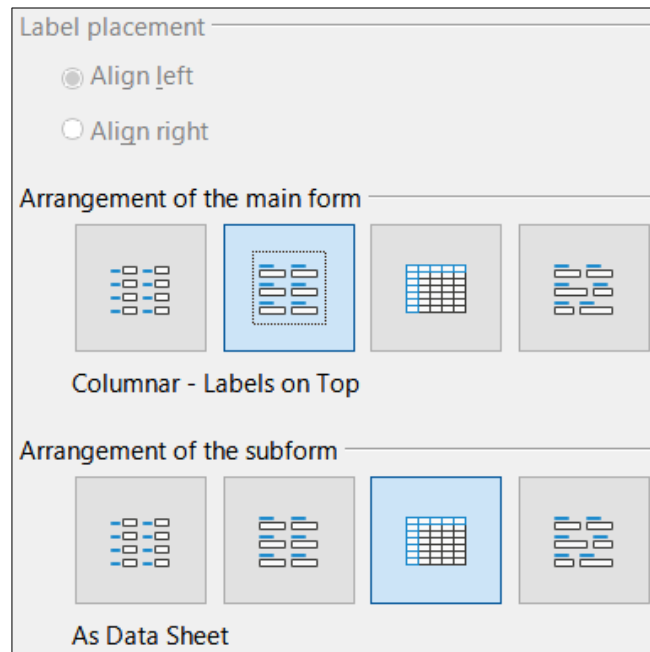

Figure 256: Arrange controls

Step 6: Set data entry

In this example, accept the default settings and click **Next**.

Step 7: Apply styles

- 1) Select the color you want in the *Apply styles* list. In this example, use the **Beige** option.
- 2) Select the *Field border* you want. In this example, use the **3D look** option. You might want to try different settings.
- 3) Click **Next**.

Step 8: Set name

- 1) Enter the name for the form. Use *Vacations*.
- 2) Click **Modify the form**.
- 3) Click **Finish**. The form opens in edit mode, Base will display the Fuel – LibreOffice Base: Database Form window.

Modifying a form

When a form is generated with the Wizard (Figure 257), it usually needs to be reformatted. Figure 257 is not organized at all. Every control seems to have a different size and the color needs to be changed.

Figure 257: Basic form created using Wizard

These controls are different sizes because they contain different types of field data. Since Base has three types of controls (text, formatted, and date), these fields are formatted differently. The width of text controls is designed to display a large number of characters, while formatted controls are shorter because they will usually contain numbers or decimals. Date controls are fairly short, except for the date formats is day of the week, month, day, year (Thursday, October 31, 2020), which requires a larger width than 10/31/2020 or 31/10/2020.

First, we will modify the payment type controls. These fields need to be replaced with a list box, and each list box will be related to an existing field in the table, Payment Type.

Note

The following steps assume that the PaymentType table already contains three single-field records. These might be *Cash*, *Dan*, and *Kevin*. If necessary, you could use the Form Wizard to create a very simple form to input or edit these values.

Next, we will carry out the following steps:

- 1) Replace fields with list boxes.
- 2) Modify text controls (label field first and then the data field).
- 3) Modify the date control.
- 4) Modify formatted controls.
- 5) Modify fields in the table.
- 6) Group the controls (food, fuel subform, and miscellaneous).
- 7) Modify the memo control.
- 8) Add headings (for each group in the form).
- 9) Change the background to a picture, then modify some of the labels so that they can be read clearly against this background. Change the font color of the headings.
- 10) Change tab order of fields.

Figure 258 shows a section of the Form Design toolbar and key icons are identified that will be used during the following steps. Figure 266 shows the Form Navigator.



Figure 258: Part of Form Design toolbar

- (1) Design mode
- (2) Control Properties
- (3) Form Properties
- (4) Form Navigator

("End-Reading"."Odometer" - "Fuel"."Odometer") / "End-Reading"."FuelQuantity"
Fuel Economy
<input checked="" type="checkbox"/>

Figure 259: Fuel economy calculation field

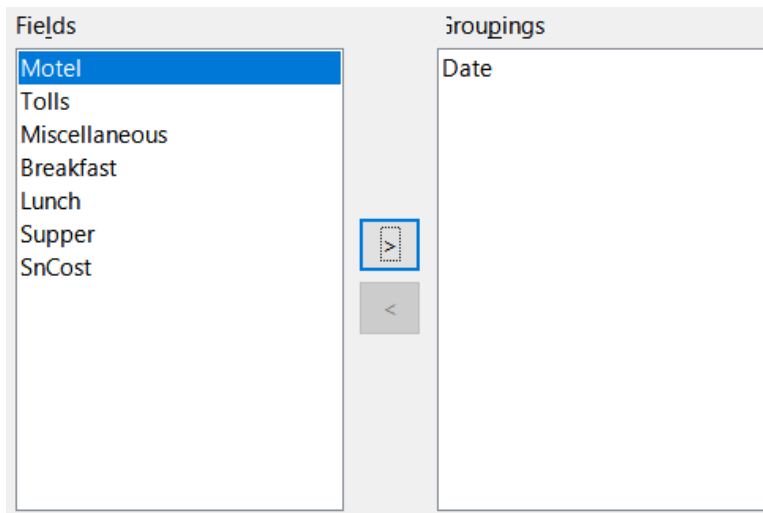

Figure 260: Selecting fields for grouping data

▼ Date He...	Date	=Date			
▼ Detail	Motel	=Motel	Breakfast	=Breakfast	Snack Cost =SnCost
	Tolls	=Tolls	Lunch	=Lunch	
	Misc.	=Miscellaneous	Supper	=Supper	

Figure 261: Report Builder template determined by the Report Wizard

Date	07-01-21			
Motel	50,00	Breakfast	11,00	Snack Cost 5,00
Tolls		Lunch	15,00	
Misc.	2,00	Supper	13,00	

Figure 262: Report without modifications



Figure 263: Data Sources navigation buttons

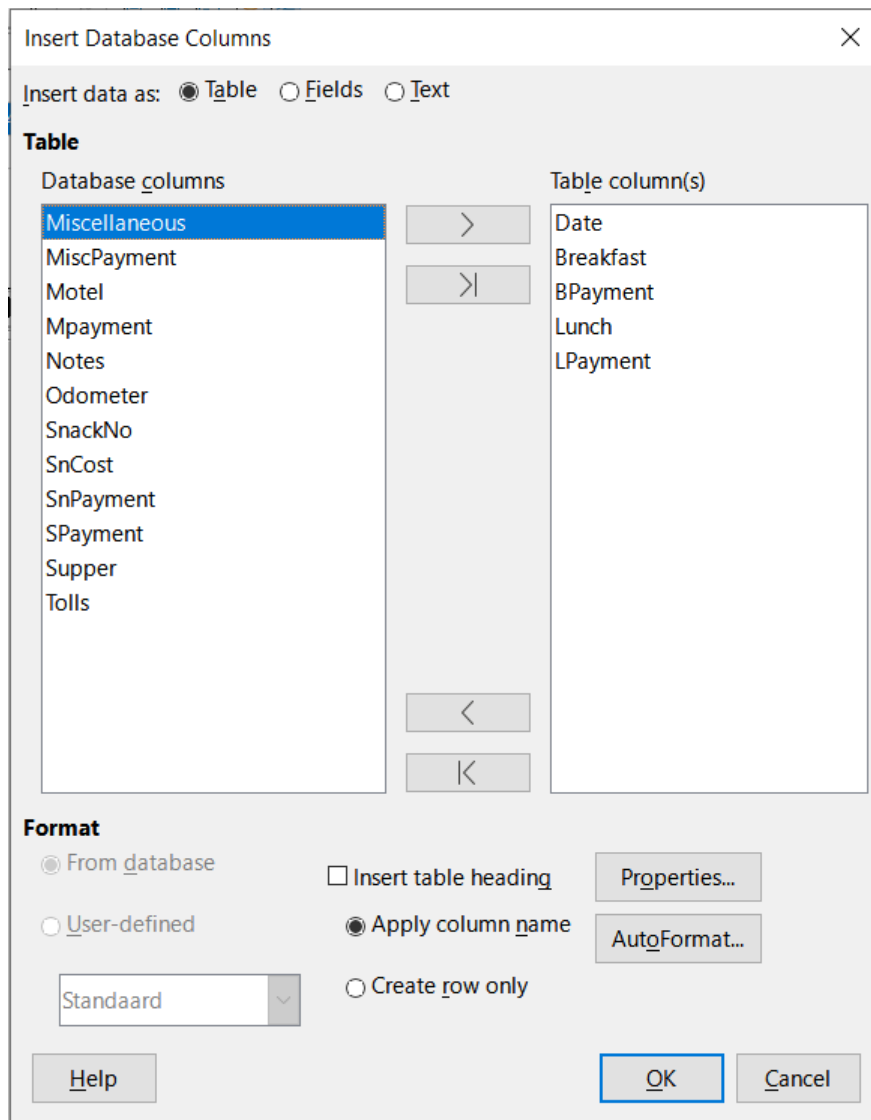

Figure 264: Insert Database Columns dialog



Figure 265: Navigation arrows of a form

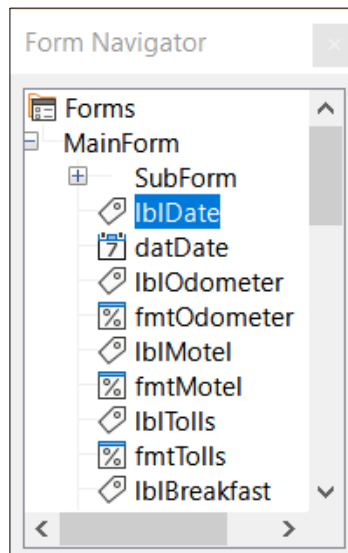

Figure 266: Form Navigator

Step 1): Replace fields with list boxes

- 1) Open the Control Properties and Form Navigator dialogs and click the **Control Properties** and **Form Navigator** icons. (You may need to select a control to make the **Control Properties** icon available)
- 2) Open the Form Navigator and click the first text box whose name contains the word "Payment".
- 3) If both the label and text box components of the field are highlighted in the Form Navigator, double-click the text box so that only it is highlighted.



Tip

If the Form Navigator does not have the input focus, selecting a field highlights both field components (for example, label and text). If this arises, then double-clicking the required component will highlight it, and enable you to subsequently move from one component to another with a single click.

- 4) Right-click the text box in the Form Navigator, right-click to bring up the context menu, then select **Replace with > List Box**.
- 5) In the Properties dialog, the heading will become *Properties: List Box and the General tab is selected*. Scroll down to the *Dropdown* property and change **No** to **Yes**.
- 6) Select the *Data* tab.
- 7) Go to *Type of list contents*. Change *Valuelist* to *Sql*.
- 8) The line below this becomes *List content*. Click the ellipsis (...) to the right of this property to open the SQL Command – LibreOffice Base: Query Design window and the Add Table or Query dialog.
- 9) The *PaymentType* table has the required entries. Click it, and then click the **Add** button.
- 10) Close the Add Table or Query dialog.
- 11) In the SQL Command – LibreOffice Base: Query Design window, double-click **Type** in the table named *PaymentType*. This places *Type* in the *Field* row of the tabular area.

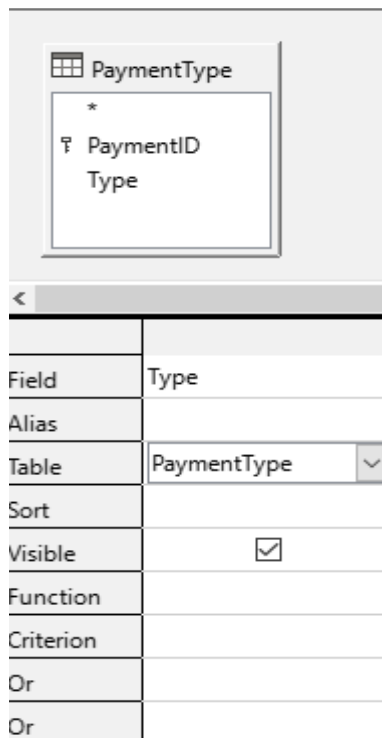

Figure 267: Selecting PaymentType

- 12) Save and close this window. The SQL code appears in the *List content* property. (SELECT "Type" FROM "PaymentType")
- 13) Change the *Bound* field value from 1 to 0.
- 14) Repeat these steps for each field containing the word "Payment", six fields in total. (See Note below before doing this.)

Tip

There are times, as in this example, when 8)) through 12)) produces the same SQL code. When this happens, copy the code. Paste the code into the *Type of list contents* property before doing 13)). It is a nice shortcut.

Step 2): Modifying text controls

- 1) In this step, you will modify the text labels and fields to make them more meaningful.
 - a) Locate the topmost text control in the Form Navigator.
 - b) Select the associated control label (begins with *lbl*). The title of the Properties dialog should have become *Label Field*.
 - c) Click the *General* tab if it is not already selected.
 - d) Click the down-arrow at the right end of the *Label* property to open the drop-down. Only then rename the label to *Payment Type* and press **Enter**.
 - e) Click on another property to save this change.
 - f) Adjust the width of the label field if necessary for the new width of the label name.
 - g) Repeat a)) through f)) for each label field in the form that contains the word *Payment*.

Note

Base allows you to paste the title of a control in multiple control fields. Once the control title *Payment Type* has been entered for the first time, it can be copied. For the next label, highlight the current label name, paste the name you want, and click another property.

- 2) Resize the fields.
 - a) Make sure that you are in the edit mode and have opened the Form Navigator and Properties dialogs.
 - b) In the Form Navigator dialog, click the field whose size you want to change.
 - c) Scroll down to the *Width* property in the Properties dialog.
 - d) Estimate the width required based on the set of possible values for this field and change the *Width* property to that value. In the case of our *Payment Type* fields, the text box should be wide enough for the longest possible payment type value of "Kevin".

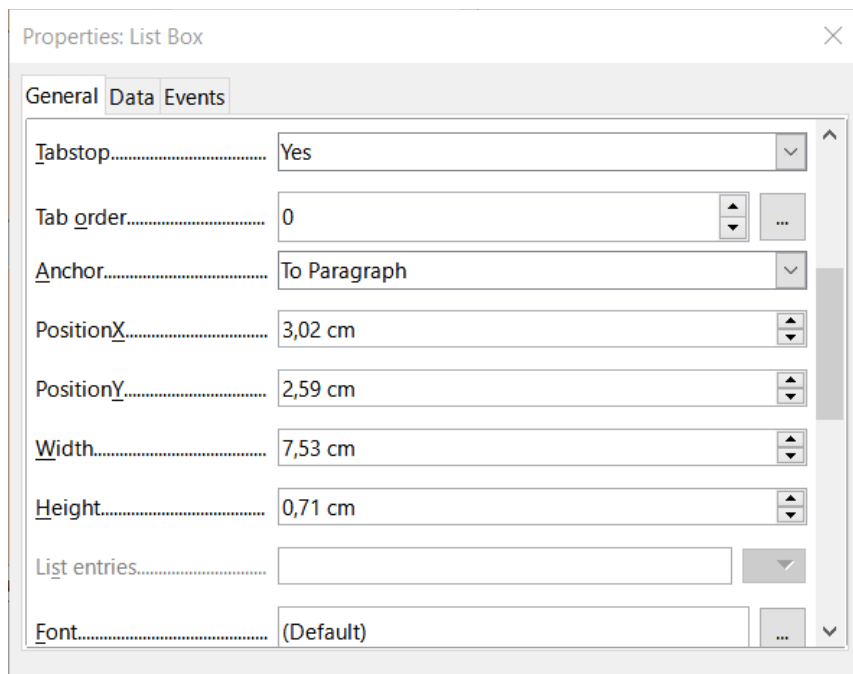

Figure 268: Modifying listbox properties

- e) Click either the *PositionY* or the *Height* property to save the change. Also, clicking on any other property will do the same thing.
- f) Use these same steps to change the size for each of the remaining text controls, including *txtSnackNo* and all the payment type fields.

Step 3): Modify date control

- 1) With the Properties and Form Navigator dialogs open, select the **datDate** field in the Form Navigator dialog. The heading of the Properties dialog changes to Properties: Date Field.
- 2) In the *General* tab of the Properties dialog, scroll down to the *Date format* drop-down list, and select the date format you desire.
- 3) Scroll down to the *Dropdown* property and select **Yes**.
- 4) Is the width of the *Date* field inappropriate for the selected format? If so:

- a) The *Date* field has a border around it.
- b) Move the cursor over the middle green marker on the right side of the *Date* field. It should become a horizontal double arrow. Drag this to the right to increase the width. Drag it to the left to reduce the width. (It may take several attempts to get this right.)

Step 4): Modify formatted controls

Next, make a list of the formatted fields and their labels in the Form Navigator. The fields have the *fmt prefix*. (There are eight of them.)

One of these fields, Odometer, contains the odometer readings as integers. The rest are currency fields.

Perform the following tasks with each field:

- 1) Revise the label of the control so it has the proper annotation. In the case of *lblSnCost*, change it to *Snack Cost*.
- 2) Click the label of the control to be modified in the Form Navigator. If the border for the label is longer or shorter than the text in the label, adjust its width as described for the *Date* field above.
- 3) Click this formatted field in the Form Navigator list.
 - a) Under the *General* tab, scroll down to the *Formatting* property.
 - b) Click the ellipsis (...) on the right to open the Format Number dialog.
 - c) For the Odometer field click **Number** in the *Category* list, otherwise click **Currency**.
 - d) Under *Format*, select a field.
 - e) Select the desired number of decimal places (one for *Odometer*, two otherwise).
 - f) Select the desired number of leading zeros.
 - g) **Negative numbers red**: check if yes, remove the check if no.
 - h) **Thousands separator**: check if yes, remove check if no.
 - i) Click **OK**.
 - j) If the width of the field is not correct for the selected format, adjust its width as described for the *Date* field above.
- 4) Repeat these steps for each field name in the Form Navigator that begins with *fmt*.

Step 5): Modify fields in the table

The labels in the controls are in the column headings and the values of the field are in the column. The Form Navigator does not show any information about them. So modifications must be done using the Properties dialog.

The controls in the table control must be modified. To change things, access that particular control's properties by clicking the header.

- 1) Click the *Date* label (select the column named *Date*).
 - a) Scroll to the *Date format* property and select the format you desire from the drop-down list, if that format differs from the default setting.
 - b) Scroll to the *Width* property. Adjust the width if necessary.
 - c) Scroll to the *Dropdown* property. If you want to have a small calendar pop-up window, select **Yes**.
- 2) Click the *FuelCost* label.

- a) Open the drop-down list for the *Label* property. Add a space between *Fuel* and *Cost* then press *Enter*.
 - b) Scroll to the *Formatting* property. Click the ellipsis (...) on the right. Select *Currency* from the *Category* column. Uncheck the *Negative numbers red* and the *Thousands separator*. Click **OK**.
 - c) Scroll to the *Width* property. Adjust the width if necessary.
 - d) Change the *Alignment* property if you do not want data to be to the left. Select **Center** to put the data in the middle of the cell.
- 3) Click the *FuelQuantity* label.
- a) Open the drop-down list for the *Label* property. Add a space between *Fuel* and *Quantity*. Press *Enter*.
 - b) Scroll to the *Formatting* property and change to show three decimal places if needed.
 - c) Scroll to the *Width* property. Adjust the width if necessary.
 - d) Change the *Alignment* property if you do not want data to be to the left. Select **Center** to put the data in the middle of the cell.
- 4) Click the *Odometer* label.
- a) Scroll to the *Formatting* property. If you wish to show one decimal place, make the change.
 - b) Scroll to the *Width* property. Adjust the width if necessary.
 - c) If you do not want data to be to the left, change the *Alignment* property and if you want to put the data in the middle of the cell, select **Center**.
- 5) Click the *PaymentType* label.
- a) Right-click this label, then add a list box in a context menu by selecting **Replace with > List Box**.
 - b) Open the drop-down list for the *Label* property. Add a space between *Payment* and *Type*. Press *Enter*.
 - c) On the *Data* tab, change the *Type of list contents* property to **Sql**.
 - d) Paste the SQL code `SELECT "Type" FROM "PaymentType"` into the *List content* property. (This is a shortcut method – see the Tip on page 343 and the detailed instructions above it if you want more details).

Step 6): Group the controls:

This is a suggested layout which looks reasonably well organized. Use this one or create one that appeals to you. The controls may be wider or narrower than yours because of the content that will be in them. Note that this layout has left space for the additional labels that will be added later.

- 1) Three icons need to be activated on the Form Design toolbar: **Display Grid**, **Snap to Grid**, and **Helplines While Moving**. If this toolbar is on the side of the form, click the double arrow (») to open a sub toolbar showing them. If the toolbar is on the top or bottom of the form, they are on the right end of it. If there is a double arrow at the end, click it to reveal them. Make sure they are highlighted as in this figure.

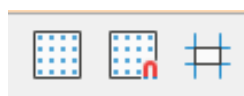

Figure 269: Help for moving controls

- 2) Some of the controls need to be moved in pairs so the Form Navigator needs to remain open. Close the Properties dialog now.

 **Tip**

You can also control the **Display Grid**, **Snap to Grid**, and **Helplines While Moving** options using the **View > Grid and Helplines** menu.

 **Note**

When moving a control, do not use the *PositionX* and *PositionY* properties to place the control, because this will place the control's label and field on top of each other. Those properties can move a label or field to a specific location, but are not designed to move a control. Use the **Position and Size** icon on the Form Design toolbar to move a control or group of selected controls.

The list in the Form Navigator reveals which controls needed to be grouped based upon their names:

- *lblMotel / fmtMotel* with *lblMPayment / txtMPayment*;
- *lblBreakfast / fmtBreakfast* with *lblBPayment / txtBPayment*;
- *lblLunch / fmtLunch* with *lblLPayment / txtLPayment*;
- *lblSupper / fmtSupper* with *lblSPayment / txtSPayment*;
- *lblSnackNo / txtSnackNo* with *lblSnCost / fmtSnCost* and with *lblSnPayment / txtSnPayment* (group these three controls together);
- *lblMiscellaneous / fmtMiscellaneous* with *lblMiscPayment / txtMiscPayment*.

That is six groups of controls; each one will be moved separately.

The layout shows where each control of a group goes for each of these groups. For most of them, the first control holds the cost, and the second contains the payment type in a row. The Snacks places the number of snacks followed by the cost and then the payment type. The Miscellaneous controls contains the payment below the cost.

- 1) Before you move an entire group to a new location, move the controls within the group to where you want them to be relative to each other.
 - a) Click on the first control, placing a border around it.
 - b) Place the mouse pointer over the label or field where it changes its shape.
 - c) Drag it to an open area of the form.
 - d) Using the same method, move the second control to the correct position relative to the first control.
 - e) As soon as you begin to move it, the helplines will appear. Use them to line up the edges of the controls before releasing the mouse button.
 - f) If there is a third control, move it to the correct position relative to the second one.
- 2) Move the controls for the group to where you want them:
 - a) Click the first component in the Form Navigator list.
 - b) Use the standard *Control+Click* and *Shift+Click* mechanisms until all of the labels and fields in this group are highlighted.
 - c) Place the mouse pointer over one of the labels or fields changing the arrow.
 - d) Drag the group to where you want its controls to be.

- 3) Repeat for the other controls using these same steps. If a group is going to be below another group of controls, use the helplines to line up the left end of the two groups (for example: first control under left control).

Figure 270: Form suggested layout

Step 7): Modify memo control

The size of the *Note* control allows it to be moved to a place that permits the controls of the form to be organized without changing the size of the *Note* control. If the size needed modification, this is done using the same methods as for other text controls.

The other modification is adding scrollbars. The choices are none, vertical, horizontal, or both.

- 1) To change the size of this control, follow the same steps for changing the size for any text control.
- 2) If necessary, move the control to the required position using the same steps described above for grouping the controls (Step 6)).
- 3) Click the **Control Properties** icon on the Form Design toolbar if the Properties dialog is not open.
- 4) Select the *txtNotes* control in the Form Navigator dialog.
- 5) On the Properties dialog, click the *General* tab if it is not selected.
- 6) Scroll down to the *Text type* property.
- 7) Select the **Multi-line** option in its drop-down list.
- 8) Scroll down to the *Scrollbars* property.

- 9) In its drop-down list, select the option you need (**None**, **Vertical**, **Horizontal**, or **Both**).
- 10) Close the Properties dialog.

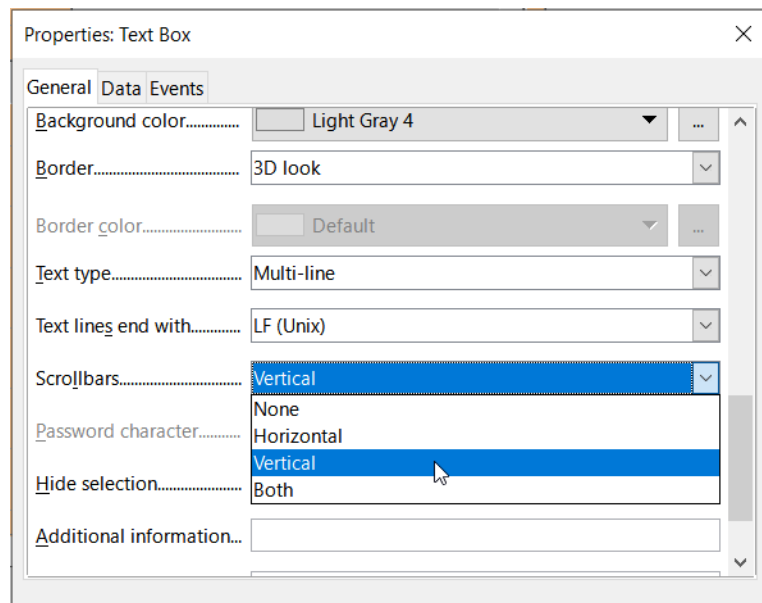

Figure 271: Scroll bar selections in the Properties dialog

Step 8): Add headings

This task is easier to complete if you have end-of-paragraph markers visible. You should turn them on by selecting **View > Formatting Marks**, clicking the **Toggle Formatting Marks** icon on the Standard toolbar, or by pressing *Ctrl+F10*.

- 1) Make sure that the cursor is in the top left hand corner of the Database Form window.
- 2) Move the cursor with the *Enter* key until it aligns with the gap between the *Date* field and the *Breakfast* field.
- 3) Select the **Heading 2** style from the *Set Paragraph Style* drop-down list.
- 4) Place the input cursor where the first heading should be. Enter the heading *Meals*.
- 5) Move the input cursor with the space bar to the location where the second heading will appear. Type the heading *Snacks*.
- 6) Press the *Enter* key repeatedly to move the cursor down until it aligns with the gap between the *Supper* field and the table.
- 7) If the style has changed, use the *Set Paragraph Style* drop-down list on the Formatting toolbar to reselect the **Heading 2** style.
- 8) Move the input cursor to the position where you want the table heading to appear. Type the heading *Fuel Data*.

Tip

The Styles deck can be opened by selecting **View > Styles** or by pressing *F11*. Also, you can quickly modify the appearance of all three headings by right-clicking the *Heading 2* style and selecting the **Modify** option in the context menu would allow. See the *Writer Guide* for details.

Step 9): Change the background

The background for a form can be a color or an image. Select a color from the color palette at **Tools > Options > LibreOffice > Application Colors** or create a custom color from the RGB fields.

To add a color to the form background:

- 1) Right-click the form and select **Page Style** in the context menu.
- 2) The Page Style dialog (Figure 272) will appear. Make sure the **Area** tab is selected.

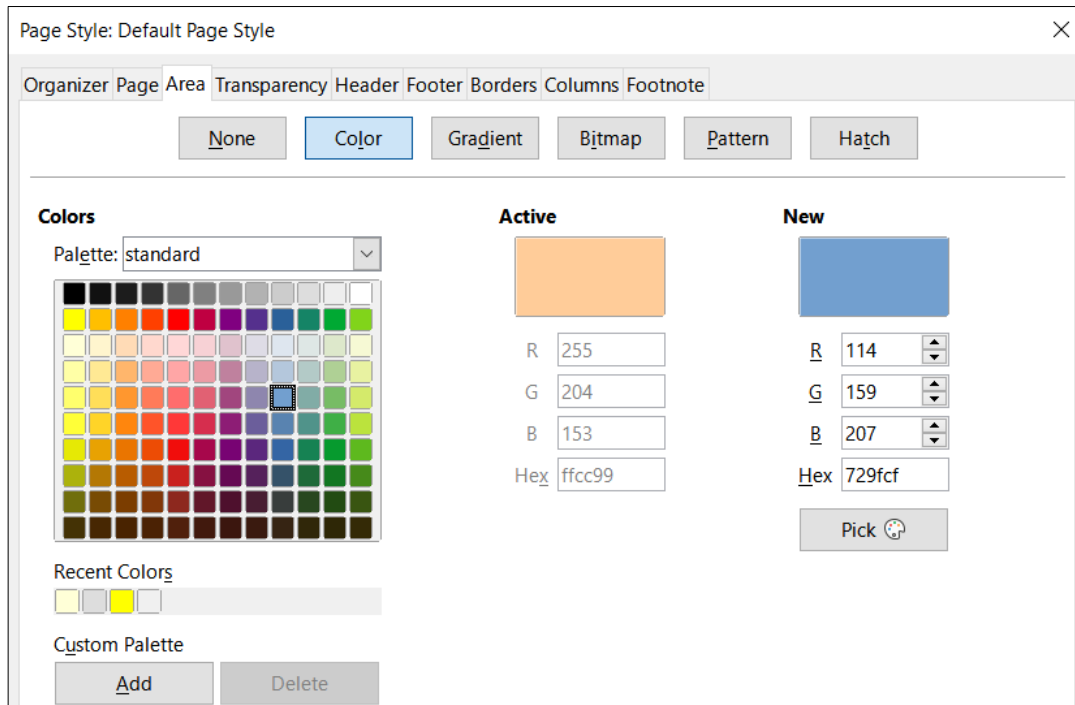

Figure 272: Page Style dialog

- 3) Select **Color** in the row of buttons near the top of the tab.
- 4) Select a color from the grid. If you wish to access more choices, choose a palette from the Palette drop-down menu or use the *RGB* or *Hex* boxes to create a specific color or click **Pick** for even more choices.
- 5) Click **Apply** to see what your selection will look like in your form.
- 6) Change if necessary.
- 7) Click **OK** to accept your color choice and close the dialog.

To add other form backgrounds:

- 1) Perform steps 1) and 2) from the previous numbered
- 2) Select the type of background from the row of buttons: **None**, **Gradient**, **Bitmap**, **Pattern**, or **Hatch**.
- 3) In the selected type, choose one of the selections provided or create your own. For details, see Chapter 4, Changing Object Attributes, in the Draw Guide.
- 4) Click **Apply** to see what your selection will look like in your form.
- 5) Click **OK** to accept your choice and close the dialog.

If you selected a bitmap in the list, the form might look like Figure 273.

Step 10): Change the tab order

The *Tab* key moves the cursor from field to field. This method permits us to group our expenses into areas before we begin entering data. For example, all of our meal receipts can be grouped together as can our snacks and also our fuel purchases.

The screenshot shows a form with the following sections and fields:

- Date**: A dropdown menu.
- Odometer**: A text input field.
- Tolls**: A text input field.
- Motel**: A text input field.
- Payment Type**: A dropdown menu.
- Meals**: A section containing three rows of fields:
 - Breakfast**: A text input field and a **Payment Type** dropdown menu.
 - Lunch**: A text input field and a **Payment Type** dropdown menu.
 - Supper**: A text input field and a **Payment Type** dropdown menu.
- Snacks**: A section containing two rows of fields:
 - Snack No.**: A text input field, **Snack Cost**: a text input field, and **Payment Type**: a dropdown menu.
 - Miscellaneous**: A text input field, **Payment Type**: a dropdown menu, and **Notes**: a text area with a scrollbar.
- Fuel Data**: A table with the following columns: **Date**, **Fuel Cost**, **Fuel Quantity**, **Odometer**, and **Payment Type**. The table is currently empty.

At the bottom of the form, there is a **Record** field, an **of** field, and a set of navigation buttons (back, forward, etc.).

Figure 273: Finished form

- 1) Select **View > Toolbar > Form Design** to open the Form Design toolbar.
- 2) Click the **Activation Order** icon (circled in Figure 274).



Figure 274: Form Design toolbar with Activation Order icon circled

- 3) Rearrange the field order in the Tab Order dialog.
 - a) If you click the **Automatic Sort** button, Base will automatically generate a tab order.
 - b) You can use the **Move Up** and **Move Down** buttons to change the position of a selected control in the list.
 - c) If necessary, drag a control from one position to another in the *Controls* list.
 - d) Define a tab order. If you like, you can put the fields in the same order as Figure 275.
 - e) Click **OK**.
- 4) Save and close the form.
- 5) Save the database.

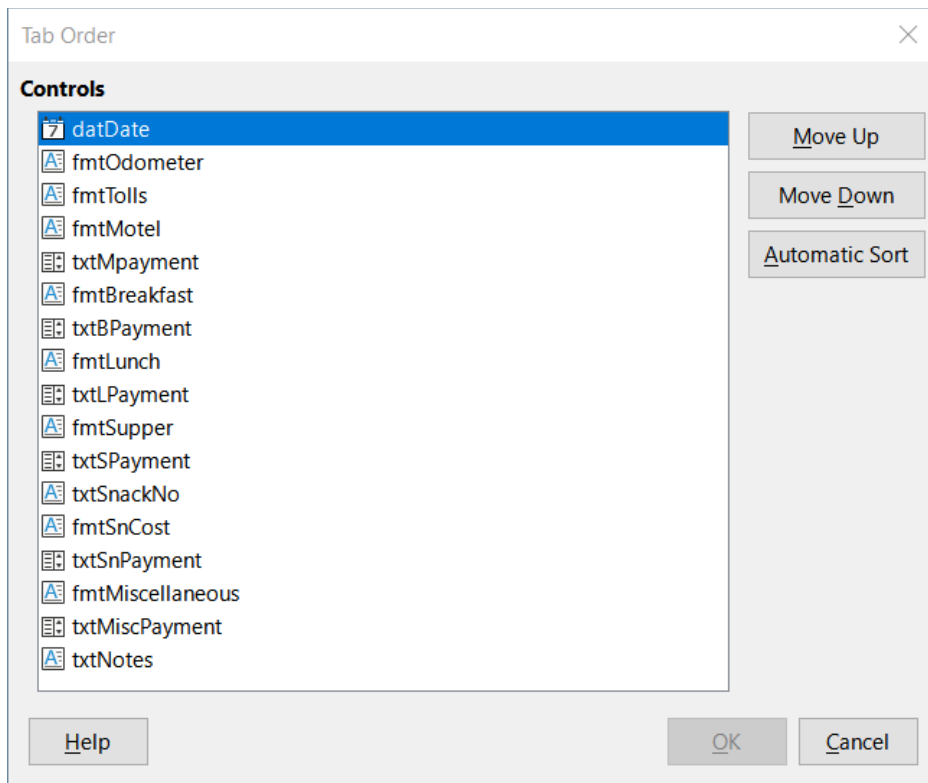

Figure 275: Possible tab order for the Vacations form

Entering data in a form

Different types of fields allow different methods of data entry. In many cases, more than one data entry method can be used.

First, open the form from the main database window (Figure 236).

- 1) Click the *Forms* icon in the *Database* list, or select **View > Database**, or press *Alt+M*.
- 2) Find the form's name in the *Forms* list (Vacations).
- 3) Double-click the form's name.

The quickest way to enter a date in the *Date* field is to click on the arrow that opens the drop-down calendar (Figure 276) and select the day that you want. Then press the *Tab* key to go to the next field.

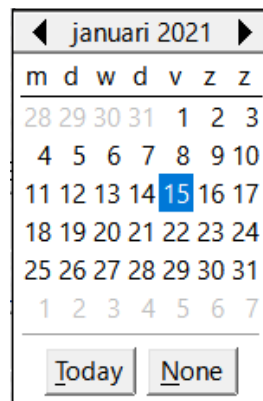

Figure 276: Calendar drop down

The *Odometer*, *Tolls*, and *Motel* fields are numeric fields. Enter values directly into them, or use the up and down arrows (if you chose to display to displace the arrows when the form was created). After you have entered a value in a field, use the *Tab* key to go to the next field.

- To increase the value, click on the up arrow. If you need to decrease the value, click on the down arrow.
- The up and down arrows only change the numbers to the left of the decimal place.
- If you need to change numbers to the right of the decimal place, delete them and enter the desired numbers.

The Motel's *Payment Type* field is a drop-down list. If the elements of the list start with different letters, you move to a field by entering the first letter of the field's title.

- If two or more elements of the list have the same first letter, repeated typing of the first letter will cycle through these elements.
- When the selection is correct, use the *Tab* key to go to the next field.

The form's remaining fields are either numeric fields or drop-down lists until you reach the Notes field (which is a text field). Type anything you desire in this field just as you would any simple text editor.

Note

The *Tab* key is used to move between fields. However, there are some limitations where other keys.

Since text fields do not have tab positions, they can not move from one position in the field to another one. All spacing must be done by the space bar.

The *Enter* key can be used to move between non-text fields, but the function of the Enter key in text fields depends upon whether the text field has a single line property. If it does, pressing *Enter* will move the cursor to the next field. But if the text field has been assigned a multi-line property, pressing *Enter* moved will only move the cursor down one line. With this field, the *Tab* key has to be used to move the cursor to the next field.

If there was no subform for fuel data, pressing the *Tab* key in the last field would save all of the fields, clear them, and make the form ready to accept data for the next record.

Because we have a subform, the *Tab* key has a different function. It places the cursor in the first *Date* field of the subform with the date automatically entered to match the *Date* field of the main form.

The *Fuel Cost*, *Fuel Quantity*, and *Odometer* fields are numeric fields. The *Payment Type* field is a drop-down list. Enter the data just as you did in the main form, and use the *Tab* key to go to the next field.

When you use the *Tab* key to leave the *Payment Type* field, it goes to the *Date* field of the next line and automatically enters the date. Now you can enter your second set of fuel data for this day.

When the form has a subform, click any of the fields of the main form to move to another record. In this case, click the *Date* field of the main form. Then use the directional arrows at the bottom. Move from left to right: *First Record*, *Previous Record*, *Next Record*, and *Last Record* (all have keyboard shortcuts identified in their extended tips). To the right of these arrows is the *New Record* icon.

To create a new record while in the last record of the main form, click either the *Next Record* icon or the *New Record* icon.

Tip

Each record is numbered and the Record box contains the number of the record whose data is shown in the form.

If you need to go to a specific record, enter the record's number into the record box and type *Enter* to take you to that record.

Figure 277 is a record with data inserted in its fields.

The screenshot shows a database form with the following sections:

- Main Form Fields:** Date (Sunday, April 19, 2020), Odometer (530.0), Tolls (empty), Motel (\$50.00), Payment Type (Kevin).
- Meals Section:**
 - Breakfast: \$11.00, Payment Type (Dan)
 - Lunch: \$15.00, Payment Type (Dan)
 - Supper: \$13.00, Payment Type (Kevin)
- Snacks Section:**
 - Snack No.: 3, Snack Cost: \$5.00, Payment Type (Cash)
 - Miscellaneous: \$2.00, Payment Type (Cash)
- Fuel Data Table:**

Date	Fuel Cost	Fuel Quantity	Odometer	Payment Type
04/19/20	\$16.00	14.690	704.2	Kevin
04/19/20	\$7.00	6.430	778.7	Dan
04/19/20	\$20.00	19.570	1,032.3	Dan
04/19/20	\$16.00	15.150	1,239.4	Cash
04/19/20	\$16.00	15.144	1,493.4	Kevin
- Notes Field:** Bought two toothbrushes for \$2.00.
- Record Navigation:** Record 4 of 5, with navigation icons for first, previous, next, last, and refresh.

Figure 277: Sample record of the Vacations form and subform

Quickly populate a table with data from a spreadsheet

You can drag and drop a spreadsheet that uses the format for a database table into a database table by doing the following:

- 1) Open the database file in the LibreOffice Base window (Figure 236) and select the Table view.
- 2) Open the spreadsheet in Calc. Use a sheet that is formatted the same as the database table.
- 3) Place the two windows side by side in the desktop.

- 4) Drag the sheet tab at the bottom of the Calc window into the table list of the database file. The mouse pointer shows a square with a + sign. (Sheet tab: This has the name of the sheet on it.)
- 5) Drop the sheet by releasing the mouse button. The Copy table wizard appears to help you migrate the content to the database table.
- 6) When the first page of the wizard appears to select the options of the copy operation and name the database table. Each option is explained in the Help (F1). Next, use the second page select the sheet columns you want to copy into the table. And finally, the third page of the wizard allows you to define the data type of each column of your table.
- 7) Click **Create** to populate the new table with the spreadsheet data.

Note

The Copy table operation copies only values and strings from the Calc spreadsheet. It **does not** copy formulas.

Creating queries

If you need get specific information from a database, use a query. Their results are special tables within the database. This document will demonstrate two different methods for building queries by:

- Use the Query Wizard to generate a list of albums from a particular artist from the CD-Collection table.
- The information we might want from the Fuel table includes what our fuel economy is. We will do this using Design View. (Queries that require calculations are best created with Design View.)

Method 1: Use the Wizard to create a query

Queries created by the Query Wizard provide a list of information—a single answer or multiple answers, depending upon the circumstances.

To generate a query with the Wizard, do the following:

- 1) Open the main database window (Figure 236).
- 2) Click the **Queries** icon in the Database section.
- 3) Select **View > Queries**, or press *Alt+Q*.

In the *Tasks* section, click **Use Wizard to Create Query**. The Query Wizard dialog opens (Figure 293). We will use the query to find albums by a certain musical group or individual (the album's artist), including when each album was bought.

Note

When working with a query, more than one table can be used. Since different tables may contain the same field names, the format for naming fields in a query is *table name.field name*, with a period (.) between the table name and the field name. For example, the Lunch field of the Vacations table used in a query has the name *Vacations.Lunch*.

Step 1: Select the fields

- 1) Select the **Table: CD-Collection** option in the *Tables* drop-down list.

- 2) Find the *Available fields* list fields in the CD-Collection table:
 - a) Click *Artist*, and use the > button to move it to the *Fields in the Query* list.
 - b) Move the *AlbumTitle* and *DatePurchased* fields in the same manner. You can also move a single field from one list to the other by double-clicking.
 - c) If you make a mistake, you can return an unwanted field from the *Fields in the Query* list to the *Available fields* list by selecting it and then typing the < button.
 - d) In other circumstances, you can use the >> and << buttons to move all fields in one list to the other list.
- 3) Click **Next**.



Tip

To change the order of the fields, select the field you want to move and click the up or down arrow to the right of the *Fields in the Query* list.

Step 2: Select the sorting order

Base allows you to sort the information of our query with up to four fields. In this step, we must first decide which field is most important. In this query, the artist field is most important to us, next field is the album title, and finally the date purchased field is of least importance.

Figure 278: Sorting order page

- 1) Click the first *Sort by* drop-down list.
 - a) Select the **CD-Collection.Artist** option.
 - b) To list the artists in alphabetical order (a-z), select **Ascending** on the right.
- 2) Click the first *Then by* drop-down list.
 - Select **CD-Collection.AlbumTitle** and then select **Ascending**.
- 3) Click the second *Then by* drop-down list.
 - Select **CD-Collection.DatePurchased** and then select **Ascending**.
- 4) Click **Next**.

Step 3: Select the search conditions

Next, we will compare the name we entered with the names of the artist in our database and decide whether to include a particular artist in our query results or not.

The following options are available:

- *is equal to*: the same as
- *is not equal to*: not the same as
- *is smaller than*: comes before

- *is greater than*: comes after
- *is equal or less than*: the same as or comes before
- *is equal or greater than*: the same as or comes after
- *like*: similar to in some way
- *not like*: is not similar to
- *is null*:
- *is not null*:

Note

These conditions apply to numbers, letters (using alphabetical order), and dates.

- 1) Since we are only searching for one thing, we will use the default setting of **Match all of the following**.
- 2) We are looking for a particular artist, so select **CD-Collection.Artist** in the *Fields* drop-down and **is equal to** in the *Condition* drop-down.
- 3) Type the name of the artist in the *Value* box.
- 4) Click **Next**.

Step 4: Select the type of query

We want simple information, so the default setting: **Detailed query** is what we want. Click **Next**.

Note

Since we have a simple query, the *Grouping* and *Grouping conditions* are not needed. Steps 5 and 6 of the wizard are skipped in our query.

Step 7: Assign aliases if desired

The fields, *AlbumTitle* and *DatePurchased*, have names made up of two words without separation. Instead, aliases can be made containing two words each (*Album Title* and *Date Purchased*, respectively).

- 1) Change the alias for *AlbumTitle* to *Album Title*.
- 2) Change the alias for *DatePurchased* to *Date Purchased*.
- 3) Click **Next**.

Step 8: Checking results

- 1) Make sure that you have the query conditions listed in the *Overview*.
- 2) If something is wrong, use the **Back** button to move to the step that contains the error.
- 3) Then use the **Next** button to return to this step.
- 4) Name the query (suggestion: *Query_Artists*).
- 5) To the right of this are two choices. Select **Display Query**.
- 6) Click **Finish**.

Base displays the LibreOffice Base: Table Data View query showing any records that match the query. Close the window when you have finished with it.

Method 2: Use Design View to create a query

Creating a query using Design View is not as difficult as it may first seem. It may take multiple steps, but each step is fairly simple.

What fuel economy is our vehicle getting (miles per gallon in the USA)? This question requires us to create two queries, with the first query used as part of the second query.

Step 1: Open the first query in Design View

- Click **Create Query in Design View** in the *Tasks* area of the main window. Base displays the Add Table or query dialog (Figure 279) and the LibreOffice Base: Query Design window.

Step 2: Add tables to window

- 1) In the Add Table or query dialog, click **Fuel** to highlight it.
- 2) Click **Add**.
- 3) Click **Close**.
- 4) Base closes the Add Table or Query dialog and includes the Fuel table in the upper area of the Query Design window.

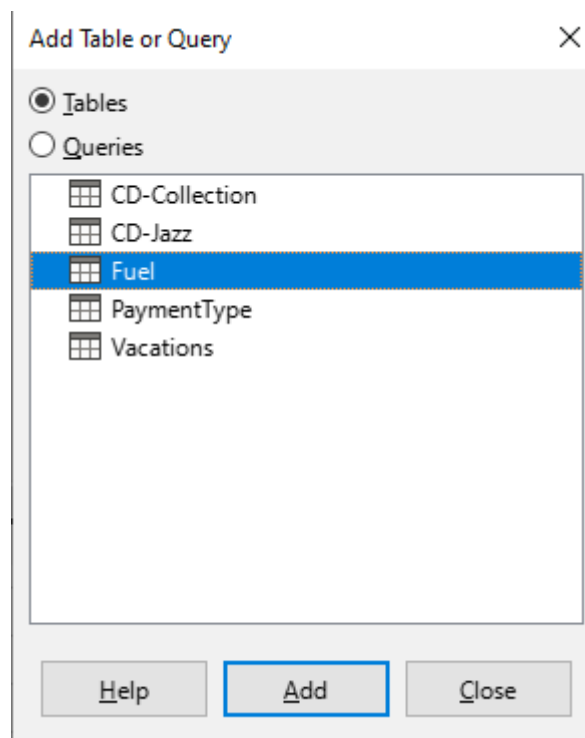

Figure 279: Add Table or Query dialog

Tip

Move the mouse pointer over the bottom edge of the *Fuel* table (Figure 280) and drag the edge to make it longer and easier to see all of the fields in the table.

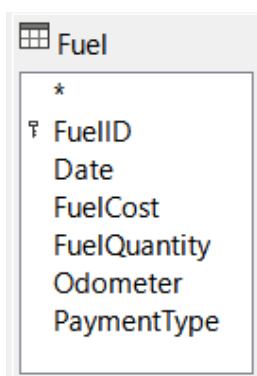

Figure 280: Fuel table in query

Step 3: Add fields to the table at the bottom

- 1) Double-click the *FuelID* field in the Fuel table.
- 2) Double-click the *Odometer* field.
- 3) Double-click the *FuelQuantity* field.
- 4) Double-click the *FuelCost* field.

The query table at the bottom of the Query Design dialog should now have four columns (Figure 294).

Step 4: Set the criterion for the query

We want the query to include *FuelID* values that are greater than 0.

- 1) Type `>0` in the *Criterion* cell under *FuelID* in the query table.
- 2) Click the **Run Query** icon on the Query Design toolbar (circled in red in Figure 281), or click **View > Run Query**, or press `F5`.



Figure 281: Run Query icon in Query Design toolbar

Base presents the results of the query in the area above the query table.

Figure 282 shows the Fuel table with sample entries. The query results based upon the Fuel table are shown in Figure 283.

	FuelID	Date	FuelCost	FuelQuantity	Odometer	PaymentType
▶	0	04/18/20	\$16.00	14.69	702.2	Kevin
	1	04/19/20	\$7.00	6.43	778.7	Dan
	2	04/20/20	\$20.00	19.57	1032.3	Dan
	3	04/21/20	\$16.00	15.15	1239.4	Cash
	4	04/22/20	\$16.00	15.14	1493.4	Kevin

Figure 282: Fuel table

	FuelID	Odometer	FuelQuantity	FuelCost
▶	1	778.7	6.43	\$7.00
	2	1032.3	19.57	\$20.00
	3	1239.4	15.15	\$16.00
	4	1493.4	15.14	\$16.00
+	<AutoField			

Figure 283: Query of Fuel table

Step 5: Save and close the query

Since this query contains the final odometer reading for our calculations, you sure name it *End-Reading* when saving it. Then close the query. Now click the **Save** icon in the main database window.

Step 6: Create the query to calculate the fuel economy

- 1) Click **Create Query in Design View** in the *Tasks* area to open a new query.
- 2) Base opens the LibreOffice Base: Query Design window and the Add Table or Query dialog.
- 3) Add the Fuel table to the query just as you did in **Step 2: Add tables to window** but **do not** close the Add Table or Query dialog.
- 4) Add the End-Reading query to this query.
 - a) Click **Queries** to get the list of queries in the database (Figure 284).
 - b) Click **End-Reading**.
 - c) Click **Add**, and then click **Close**.
 - d) Base closes the Add Table or Query dialog and displays the *Fuel* table and *End-Reading* query in the upper area of the Query Design window.

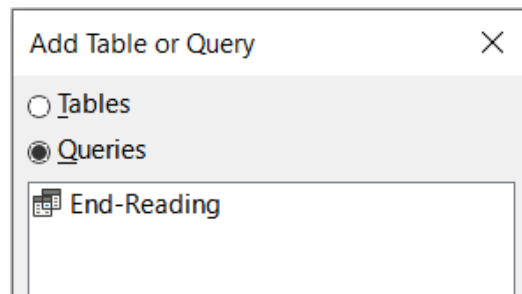

Figure 284: Selecting queries to add to another query

Step 7: Add fields to the table at the bottom of the query

When calculating the fuel economy, we will need the fuel quantity and distance traveled. Since the final odometer reading reveals the fuel quantity, we will use the *End-Reading* query to get it. We will also use the *Odometer* field from both the *Fuel* table and *End-Reading* query.

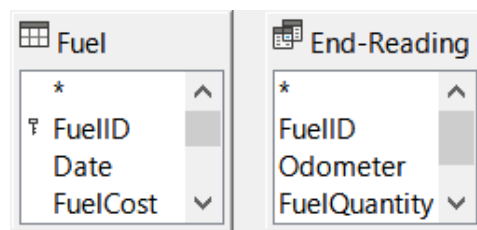

Figure 285: Tables in this query

- 1) Double-click *FuelQuantity* in the *End-Reading* query.
- 2) Double-click *Odometer* in the *End-Reading* query.
- 3) Double-click *Odometer* in the *Fuel* table.

Field	FuelQuantity	Odometer	Odometer
Alias			
Table	End-Reading	End-Reading	Fuel
Sort			
Visible	<input checked="" type="checkbox"/>	<input checked="" type="checkbox"/>	<input checked="" type="checkbox"/>

Figure 286: Added fields to the query

Step 8: Enter the FuelID difference field

The difference between the *FuelID* value of the *Fuel* table and *FuelID* value of the *End-Reading* query should equal one (1).

- 1) Type `"End-Reading"."FuelID" - "Fuel"."FuelID"` in the field to the right of the *Odometer* field of the *Fuel* table (Figure 295).
- 2) Type `= '1'` in the *Criterion* cell of this column.
- 3) Leave the *Visible* cell of this column unchecked.
- 4) Calculate the distance traveled:
 - Type in the next empty *Field* cell (Figure 296): `"End-Reading"."Odometer" - "Fuel"."Odometer"`
 - In the *Alias* row, type *Distance*.
 - Type `> '0'` in the *Criterion* cell.
- 5) Calculate fuel economy: Type `("End-Reading"."Odometer" - "Fuel"."Odometer")/"End-Reading"."FuelQuantity"` in the next column to the right of the word *Field* (Figure 259).
- 6) Type *Fuel Economy* as the alias.

Note

When entering fields for these calculations, follow this format: table or query name. Then add a period and the field name. For hyphenated or multiple-word names (table or query), use double quotes around the table or query name. The query will then add the rest of the double quotes as in Figure 259.

Use the arithmetical symbol between the two. More than one calculation can be done by using parentheses to group the arithmetical operations.

Step 9: Run the query and make some modification

First, we will run the query to make sure it works correctly. Once we are sure that the query will work, we will hide all of the fields that we do not need.

FuelQuantity	Odometer	Odometer	Distance	Fuel Economy
6,430	778,7	704,2	74,5	11,59
19,570	1032,3	778,7	253,6	12,96
15,150	1239,4	1032,3	207,1	13,67
14,144	1493,4	1239,4	254	17,96

Figure 287: Result of running the fuel economy query

- 1) Click the **Run Query** icon on the Query Design toolbar (Figure 281). The results are shown in Figure 287.

Two of the column headers are identical. By giving these two headers different aliases, we can distinguish them.

2) Add Aliases: Type the aliases as they are listed in Figure 288.

Field	FuelQuantity	Odometer	Odometer
Alias		End	Begin
Table	End-Reading	End-Reading	Fuel

Figure 288: Query table with Odometer aliases added

3) Run the query again. The results are in Figure 289.

FuelQuantity	End	Begin	Distance	Fuel Economy
6,430	778,7	704,2	74,5	11,59
19,570	1032,3	778,7	253,6	12,96
15,150	1239,4	1032,3	207,1	13,67
14,144	1493,4	1239,4	254	17,96

Figure 289: Query run with aliases

Step 10: Close, save, and name the query

Name the query *Fuel Economy*.

- 1) Click the **Save** icon.
- 2) Name the query.
- 3) Close the query.
- 4) Save the database file.

There are obviously other calculations that can be made in this query such as cost per distance traveled and how much of the cost belongs to each of the payment types.

Note

To fully use queries requires a knowledge of set operations (*unions, intersections, and, or, complements*, or any combinations of these). Having a copy of the RDBMS manuals, is also extremely useful.

Creating reports

Reports retrieve information found in the database and arrange it in useful ways. They are similar to queries except that they are designed to be read by people. Queries are only designed to retrieve selected data from the database. Reports are generated from the database's tables, views, or queries.

All reports are based upon a single table, view, or query, so first you need to decide what fields you want to use in the report. Before you use fields from different tables, you must first combine these fields in a single query or view. Then you can use this information to create a report.

For example, a report on vacation expenses includes both fuel costs and meal costs. These values are contained in fields of two different tables: Vacations and Fuel. Then this report will allow you to create a query or view.

Caution

Dynamic reports update only the *data* that is changed or added to a table or query. They do **not** show any modifications made to the table or query itself.

For example, **after** creating the report below, open the Fuel Economy query created in the previous section. For the “End-Reading”.“Odometer” – “Fuel”.“Odometer” column, change the number 1 to the number 3 (see Figure 295). The report will be identical before and after you make the change. But if you add more data to the query and run the report again, it will contain the new data. However, all data will be based upon “End-Reading”.“Odometer” – “Fuel”.“Odometer” having the value 1. **No data** will be present in the report for which “End-Reading”.“Odometer” – “Fuel”.“Odometer” has the value 3.

Example: Creating a report

We will create a report on vacation expenses. Before we create the report, we will need to know.

- What information do we want in the report?
- How do we want the information arranged?
- What fields are required to provide this information?
- Will a query or view have to be created because these fields are in different tables?
- Are any calculations required in the data before being added to the report?

The expenses for our vacation are motel, tolls, miscellaneous, breakfast, lunch, supper, snacks, and fuel. One possible report could list the totals of each of these expense groups. Another could list the expense totals for each day of the vacation. A third could list the totals for each expense group for each type of payment. (This would let us know where the money came from to pay the expenses.) Once you create a query to do any one of these, you can create a report based upon the query.

We will now create two reports. One will list the expenses each day (other than fuel) and the second listing fuel statistics. The fields we need for the first report from the Vacations table are: Date, Motel, Tolls, Breakfast, Lunch, Supper, Snack Cost, and Miscellaneous. This report only requires the Vacations table. Had the report listed the total expenses for each of these fields, we would have to create a query to provide us with these totals, which is beyond the scope of this chapter.

The next report involves the Fuel table. Since this table includes fuel purchases at times other than during the vacation, we need to create a query that contains only the fuel purchased during vacation periods.

Report Wizard vs Report Design View

- 1) When you open the Report Wizard, the Report Builder opens as well. As you make your selections in the wizard, these appear in layout in the Report Builder. When you have finished making your selections, you save the report, name it and then close it.
- 2) When using Design View to create a report, you open the Report Builder to design the layout of it. (There is only one layout available when the wizard is used.)

Vacations table report

Before we begin, we must create a new report:

- 1) Click the **Reports** icon in the *Database* area of the main Base window (Figure 236), or select **View > Reports**, or press *Alt+R*.

- 2) In the *Tasks* list, click **Use Wizard to Create Report**. The Report Wizard dialog and the Report Builder window open.

Step 1: Field selection

- 1) Select **Table: Vacations** in the *Tables or queries* drop-down list.
- 2) Use the > to move these fields from the *Available fields* list to the *Fields in report* list: Date, Motel, Tolls, Miscellaneous, Breakfast, Lunch, Supper, and SnCost. The other buttons (<, >>, <<, up arrow, and down arrow) and the double-click action perform similar functions to the other wizard pages as described earlier in this chapter.
- 3) Click **Next**.

Step 2: Labeling fields

Change any field labels you wish. We will shorten *Miscellaneous* to *Misc.* and expand *SnackCost* into two words.

- 1) Shorten *Miscellaneous* to *Misc.*
- 2) Change *SnCost* into *Snack Cost*.
- 3) Click **Next**.

Step 3: Grouping

- 1) Since we are grouping by the date, use the > button to move the *Date* field from the *Fields* list to the *Groupings* list.
- 2) You can use the < button to return an entry in the *Groupings* list to the *Fields* list. You can use the up and down arrows to re-order entries in the *Groupings* list or you can double-click to move a field from one list to the other.
- 3) Click **Next**.

Step 4: Sort options

We do not want to do any additional sorting.

- Click **Next**.

Step 5: Choose layout

- 1) Select **Columnar, three columns** in the *Layout of data* list.
- 2) *Layout of headers and footers* have no possible selections.
- 3) Select **Landscape** as the *Orientation* for the page layout.
- 4) Click **Next**.

Figure 261 shows part of the final template that has been built up in the Report Builder as you reach the end of the wizard.

Step 6: Create report

- 1) Title the report: *Vacation Expenses*.
- 2) Select the **Dynamic report** option.
- 3) Select the **Create report now** option.
- 4) Click **Finish**.
- 5) LibreOffice opens the output report in read-only mode in Writer.

The report (Figure 262) has been created. However, the date could be formatted better and all the numbers need to be formatted as currency, and the report could have a heading that includes its name, its author, and the date it was prepared. If the report had more than one page,

the page numbers could be put in a footer of each page, perhaps including the total number of pages. But to do these things, you must use Report Builder.

Report Builder: another way to create reports

The Report Builder allows you to create complex database reports. You can define group and page headers, group and page footers, and calculation fields. Report Builder is installed with LibreOffice.

While the Report Wizard allows us to create a template in Report Builder for our report. When we open Report Builder, we open it with this template. By modifying the template, we also modify the report. For example, we can change the Date field's format, and it will change the format of all the dates contained in that field in the above report. Similarly, we can change the field formatting of any of the other fields and change the format everywhere that field appears in the report.

Report Builder can also create reports by itself. To do this, click **Create Report in Design View**. For instructions on how to use the Report Builder, see Chapter 6, Reports, in the *Base Guide*.

Accessing other data sources

LibreOffice allows data sources to be accessed and then linked into LibreOffice documents. For example, a mail merge can link to an external document containing a list of names and addresses into a letter. One copy of the letter being generated for each entry.

To access a data source that is not a *.odb file:

- 1) Select **File > New > Database**, or click the arrow at the right of the **New** icon on the Standard toolbar and select the **Database** option in the menu, to open the Database Wizard.
- 2) Select **Connect to an existing database**. Select the required database type in the drop-down list. Click **Next**.
- 3) The remaining steps in the Database Wizard may vary depending on which database type you have chosen.
- 4) At some stage the wizard may prompt you to browse and select a database of interest. Normally, you will select it to register the database and open the database for editing.
- 5) Finally, click **Finish** to exit the wizard. Name and save the database in the location of your choice.

Accessing a spreadsheet as a data source

Accessing a spreadsheet is similar to accessing other databases:

- 1) Select **File > New > Database**, or click the arrow at the right of the **New** icon on the Standard toolbar and select the **Database** option in the menu, to open the Database Wizard dialog.
- 2) Select **Connect to an existing database**. Select **Spreadsheet** in the drop-down list. Click **Next**.
- 3) Click **Browse** to locate the spreadsheet you want to access. If the spreadsheet is password protected, check the *Password required* box. Click **Next**.
- 4) Make sure that the **Yes, register the database for me** and **Open the database for editing** options are selected.
- 5) Click **Finish** to exit the wizard. Name and save the database in the location of your choice.

Note

If you access a spreadsheet with this method, you cannot change anything in the spreadsheet using Base. You can only view the contents of the spreadsheet, run queries, and create reports based upon the data already entered into the spreadsheet.

All changes in a spreadsheet must be made in the spreadsheet itself with Calc. After modifying the spreadsheet and saving it, the changes will be in the database. When you create and save an additional sheet in your spreadsheet, the database will have a new table the next time you access it.

Registering *.odb databases

Databases created by LibreOffice are in the *.odb (OpenDocument Database) format. Other programs can also produce databases in this format. Registering a *.odb database is simple:

- 1) Choose **Tools > Options > LibreOffice Base > Databases**.
- 2) Under *Registered Databases*, click **New**. LibreOffice displays the Create Database Link dialog.
- 3) **Browse** to where the database is located. Make sure the registered name is correct.
- 4) Click **OK**.

Note

Sometimes after updating LibreOffice to a newer version, your list of registered database files disappears. When that happens, you can use these steps to re-register your database files with your latest version of LibreOffice.

Using data sources in LibreOffice

Once the data source is registered, whether a spreadsheet, text document, external database or other accepted data source, you can use it in other LibreOffice components including Writer and Calc.

Viewing data sources

First, open a document in Writer or Calc and view the data sources available by pressing *Ctrl+Shift+F4* or select **View > Data Sources**. This brings up a list of registered databases, including Bibliography and any other registered database, such as the Automobile database created earlier in this chapter.

To view each database, click the drop-down arrow for the database's name (Figure 290). This expands to show *Queries* and *Tables*. Click the drop-down arrow for *Tables* to view the individual tables created. Now click on a table to see all the records held in it.

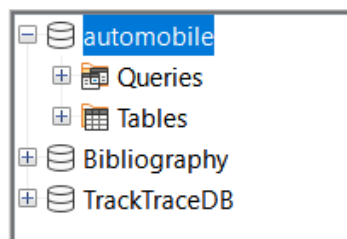

Figure 290: Databases in Data Sources window

Editing data sources

Some data sources (but not spreadsheets) can be edited in the Data Sources window. A record can be edited, added, or deleted.

View a table's data

If you click on a table, its rows and columns of data appear on the right side of the Data Sources window. Editing this data requires only a click in the cell whose data should be changed, change the data, and click in the row above or below it to save the new data.

Beneath the records are five small buttons. The first four move the cursor to the beginning, to the left, to the right, and to the end respectively. The fifth button, with a small star, inserts a new record.

To delete a record, right-click on the gray box to the left of a row to highlight the entire row, and select **Delete Rows** in the context window to remove the selected row.

FuelID	Date	FuelCost	FuelQuantity	Odometer	PaymentType
		\$16.00	14,690	704,2	Kevin
		\$7.00	6,430	778,7	Dan
		\$20.00	19,570	1032,3	Dan
		\$16.00	15,150	1239,4	Cash
		\$16.00	14,144	1493,4	Kevin

Record 1 of 5 (1)

Figure 291: Deleting a row in the Data Sources window

Launching Base to work on data sources

You can launch LibreOffice Base at any time in the Data Sources window. Just right-click on a database or its *Tables* or *Queries* components and select **Edit Database File** in the context menu. Once in Base, you can edit, add, and delete tables, queries, forms, and reports.

Using data sources in Writer and Calc

Data can be placed into Writer and Calc documents from the tables in the Data Sources window. In Writer, values from individual fields can be inserted. Or a complete table can be created in the Writer document. One common way to use a data source is to perform a mail merge.



Figure 292: Toolbar for the Data Sources window

Tip

Choose **Tools > Mail Merge Wizard** or click on the **Mail Merge** icon (circled in Figure 292) in the Data Sources window to start the Mail Merge Wizard, which steps you through creating a mail merge document. See Chapter 14 in the *Writer Guide*.

Writer documents

When you need to insert a field from a table in the Data Sources window into a Writer document, click on the field name (the gray square at the top of the field list) with the left mouse button held down, drag the field onto the document. In a Writer document, it will appear as <FIELD> (where FIELD is the name of the field you dragged).

For example, if you wish to enter the cost of meals and who paid for them on a certain date of a vacation into the database:

- 1) Open the list of data sources (*Ctrl+Shift+F4*) and select the *Vacations* table in the *Automobile* database.
- 2) Use this sentence: "On (date), our breakfast cost (amount) paid by (name), our lunch cost (amount) paid by (name), and our supper cost (amount) paid by (name)." But only type "On, our breakfast cost paid by, our lunch cost paid by, and our supper cost paid by."
- 3) To replace (date), click the field name *Date* in the Data Sources window and drag it to the right of the word *On*. Insert an extra space if necessary. The result: *On <Date>*. If you have field shadings turned on (**View > Field Shadings**), *<Date>* has a gray background. Otherwise it does not.
- 4) To replace first (amount), click the *Breakfast* field name and drag it to the right of *our breakfast cost*. Make sure you have the proper spacing between the field names and the words before and after them. Result: *breakfast cost <Breakfast>*.
- 5) To replace the first (name), click the *BPayment* field name and drag it to the right of *paid by*. Result: *paid by <BPayment>*.
- 6) In the same way, fill in the rest of the fields in the sentence.
 - Use *<Lunch>* and *<LPayment>* for the second set of (amount) and (name) in the sentence.
 - Use *<Supper>* and *<SPayment>* for the third set of (amount) and (name) in the sentence.
- 7) Final result: *On <Date>, our breakfast cost <Breakfast> paid by <BPayment>, our lunch cost <Lunch> paid by <LPayment>, and our supper cost <Supper> paid by <SPayment>*.
- 8) Add data to the fields of the sentence:
 - a) Click the gray box to the left of the row of data you want to add. That row should be highlighted like the second row of Figure 298.
 - b) Click the **Data to Fields** icon in the Table Data toolbar (circled in Figure 298). This should fill the fields with the data from the row you chose.
 - c) Click another row and then click this icon again. The data in the sentence changes to reflect this selected row of data.
 - d) Save the document if you want to use it as an example later.

Adding any data in table format is easier. Some of the steps are quite similar.

- 1) Navigate to the place you want to place the table and click the location.
- 2) *Ctrl+Click* the gray box to the left of each row of the data source that you want to be a row in your table if the rows are not consecutive. To select consecutive rows, click the gray box to the left of the top desired row and *Shift+click* the bottom desired row.
- 3) Click the *Data to Text* icon to open the Insert Database Columns dialog (Figure 264). (The *Data to Text* icon is to the left of the **Data to Fields** icon in Figure 298.)
- 4) Move the fields you want in your table from the *Database columns* list to the *Table column(s)* list.
 - To place the fields in order, click the field and use the single right arrow to move the fields in the order you desire. You can also limit the fields you use to less than all of the fields available.

- To use all of the fields, use the double arrow pointing to the right to move all of them at one time (this icon may have a different appearance in some environments). The order of the fields in the table you create will be the same as in the data source table.
 - To remove a single field from the *Table column(s)* list, click the field and use the single arrow pointing to the left.
 - You can double-click a field in one list to move it to the other list.
- 5) To start over, click the double arrow pointing to the left (this icon may have a different appearance in some environments).
 - 6) Select the settings for your table. Use the default settings as in Figure 264.
 - 7) Click **OK**. Save the document.

Calc spreadsheets

There are two ways to transfer data into a Calc spreadsheet:

Enter the data into the spreadsheet cells.

Create complete new records in the spreadsheet. While you can directly access the data inserted into the spreadsheet cells, new records created in the spreadsheet are read-only.

Use the *Data to Text* icon to enter data directly to the spreadsheet cells as if you are making a table in a Writer document. But there are certain differences.

The steps are straightforward.

Click the cell of the spreadsheet which you want to be the top left cell of your data, including the column names.

- 1) Use *Ctrl+Shift+F4* to open the Data Sources window and select the table whose data you want to use.
- 2) Select the rows of data you want to add to the spreadsheet:
 - Click the gray box to the left of the row (the row header) you want to select if only selecting one row. That row is highlighted.
 - To select multiple rows, hold down the *Ctrl* key while clicking the gray box of the rows you need. Those rows are highlighted.
 - To select all the rows, click the gray box in the upper left corner. All rows are highlighted.
- 3) Click the *Data to Text* icon to insert the data into the spreadsheet cells.
- 4) Save the spreadsheet.

Adding records to a spreadsheet is fairly easy. You need to have the Data Sources window open, your spreadsheet open, and the table you want to use selected.

- 1) Drag and drop the gray box containing the field name for the table's ID field (the column header) to where you want the record to appear in the spreadsheet.
- 2) Repeat until you have copied all of the fields you need to where you want them in the spreadsheet.
- 3) Select **File > Save**, or click the **Save** icon on the Standard toolbar, to name and save the spreadsheet. Close the file.

Next time you open the spreadsheet, the fields will be populated with data from the first record of the table, and the Form Navigation toolbar will appear at the bottom of the spreadsheet.

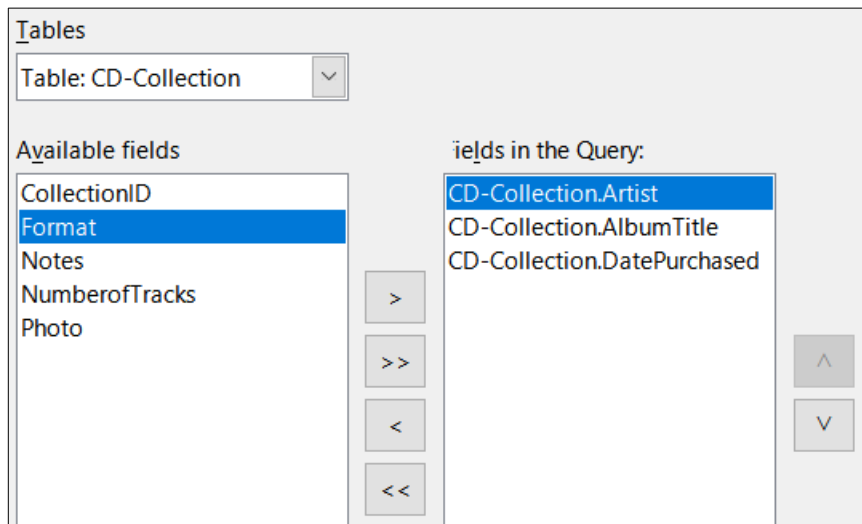

Figure 293: First page of the Query Wizard

Field	FuelID	Odometer	FuelQuantity	FuelCost
Alias				
Table	Fuel	Fuel	Fuel	Fuel
Sort				
Visible	<input checked="" type="checkbox"/>	<input checked="" type="checkbox"/>	<input checked="" type="checkbox"/>	<input checked="" type="checkbox"/>

Figure 294: Query table

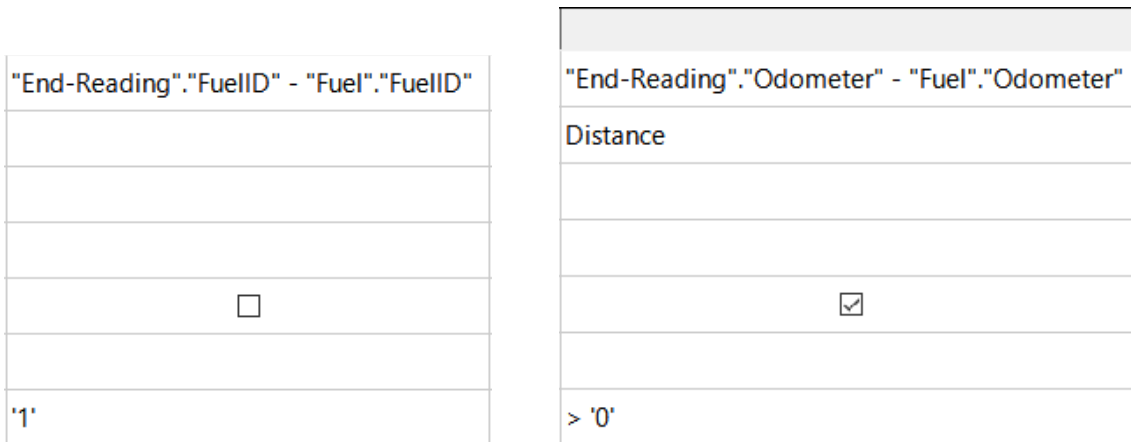

Figure 295: Typing in calculation of fields Figure 296: Field for distance traveled calculations

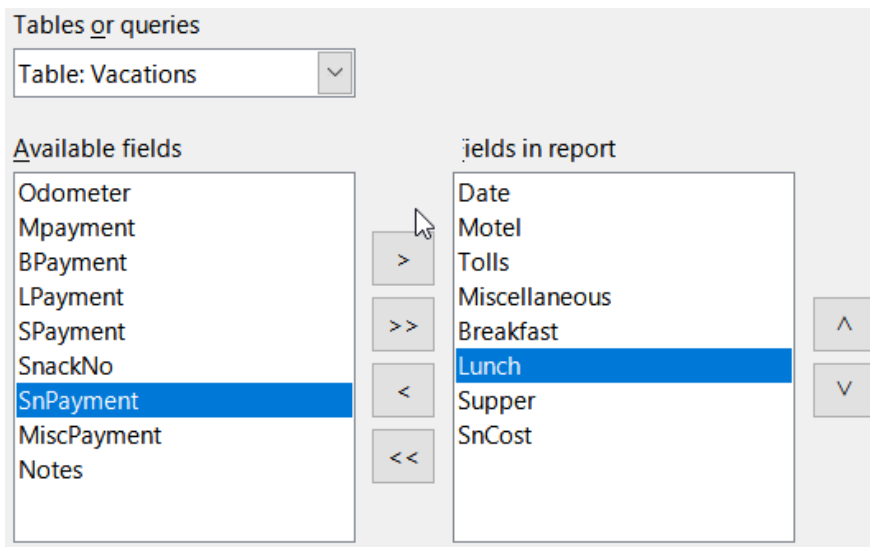

Figure 297: Adding fields to a report

	Date	Odometer	Motel	Mpayment	Tolls	Breakfast	BPayment
	07-01-21	700,0	\$50,00	Kevin		\$11,00	Kevin
	09-01-21	975,0	\$48,00	Cash	\$4,00	\$13,00	Dan

Figure 298: Selected row in Data Sources window

Miscellaneous	Misc.
Breakfast	Breakfast
Lunch	Lunch
Supper	Supper
SnCost	Snack Cost

Figure 299: Giving aliases to fields

Click the arrows on the Form Navigation toolbar to view the different records of the table. (The arrows are circled in red in Figure 265.) The number in the box changes when you change the record number by clicking an arrow. The data in the fields changes to reflect the data for that particular record number.



LibreOffice
Community



Chapter 9, Getting Started with Math

LibreOffice's Formula (Equation) Editor

Introduction

Math is a formula editor included with LibreOffice used to create or edit formulas (equations) in a symbolic form, within LibreOffice documents or as stand-alone objects. Sample formulas are shown below:

$$\frac{df(x)}{dx} = \ln(x) + \tan^{-1}(x^2) \text{ or } \text{NH}_3 + \text{H}_2\text{O} \rightleftharpoons \text{NH}_4^+ + \text{OH}^-$$

The Formula Editor in Math uses a markup language to represent formulas. This markup language is designed to be easily read by users. For example, a divided by using markup language produces the fraction $\frac{a}{b}$ when used in a formula.

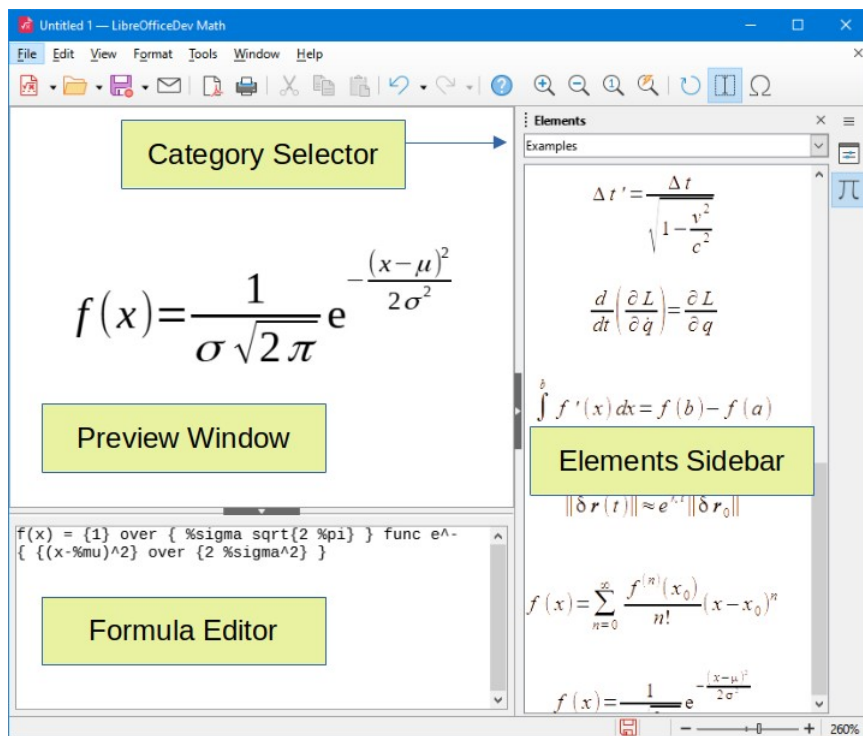

Figure 300: LibreOffice Math window parts

Getting started

The Formula Editor creates a formula as a separate file that can become a formula library or can be inserted directly into a document using LibreOffice Writer, Calc, Impress, or Draw.

Formulas as separate documents or files

To create a formula as a separate document or file, use one of the following methods to open an empty formula document in LibreOffice Math:

- On the Menu bar, go to **File > New > Formula**.
- On the Standard toolbar, click the triangle to the right of the **New** icon and select **Formula**.
- In the Start Center, click **Math Formula**.
- From within LibreOffice Math, use the keyboard shortcut **Ctrl+N**.

When the markup language in the Formula Editor is entered, the formula will appear in the Preview window as the markup language is entered in the Formula editor. If the Elements panel has been selected in **View** on the Menu bar, it may appear on the sidebar to the right of the Preview window. (Figure 301).

For more information on creating formulas, see “Creating formulas” below.

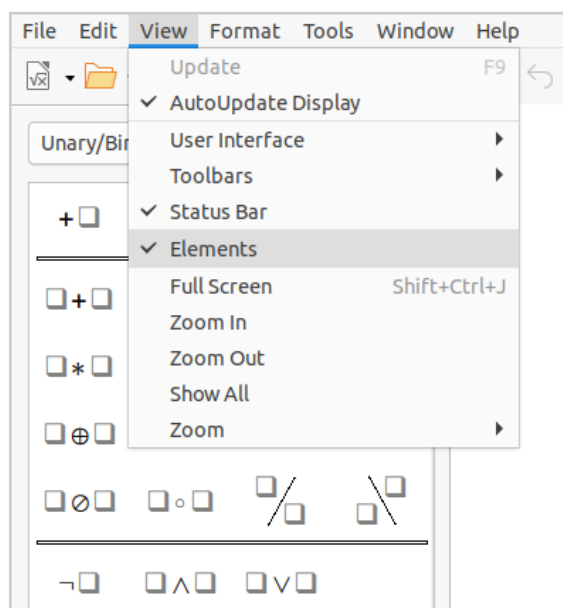

Figure 301: Enabling the Elements panel

Formulas in LibreOffice documents

To insert a formula into a LibreOffice document, open the target document in Writer, Calc, Draw, or Impress.

- In Writer, click in the paragraph where the formula should be inserted.
- In Calc, click in the spreadsheet cell where the formula should be inserted.
- In Draw and Impress, the formula is inserted into the center of the drawing or slide.

Then, go to the Menu bar and select **Insert > Object > Formula Object** to open the Formula Editor. Or, you may go to **Insert > Object > OLE Object** on the Menu bar to open the Insert OLE Object dialog, then select **Create new**, choose the **Object Type** “LibreOffice Formula” and then click **OK** to open the Formula Editor.

The Elements panel will be on the right of the Preview window if Elements has been selected in **View** on the Menu bar.

Figure 302 shows an example Writer document with the formula box selected ready for a formula to be entered.

After entering the markup language for the formula, close the Formula Editor by pressing the *Esc* key or by clicking an area outside the formula in the document. If you need to edit the formula, double-click on the formula object in the document to open the Formula Editor again.

Formulas are inserted as OLE objects into documents and can be placed in different ways. For more information on OLE objects, see “Formulas in Writer”, “Formulas in Calc, Draw, and Impress” below, and the user guides for Writer, Calc, Draw, and Impress.

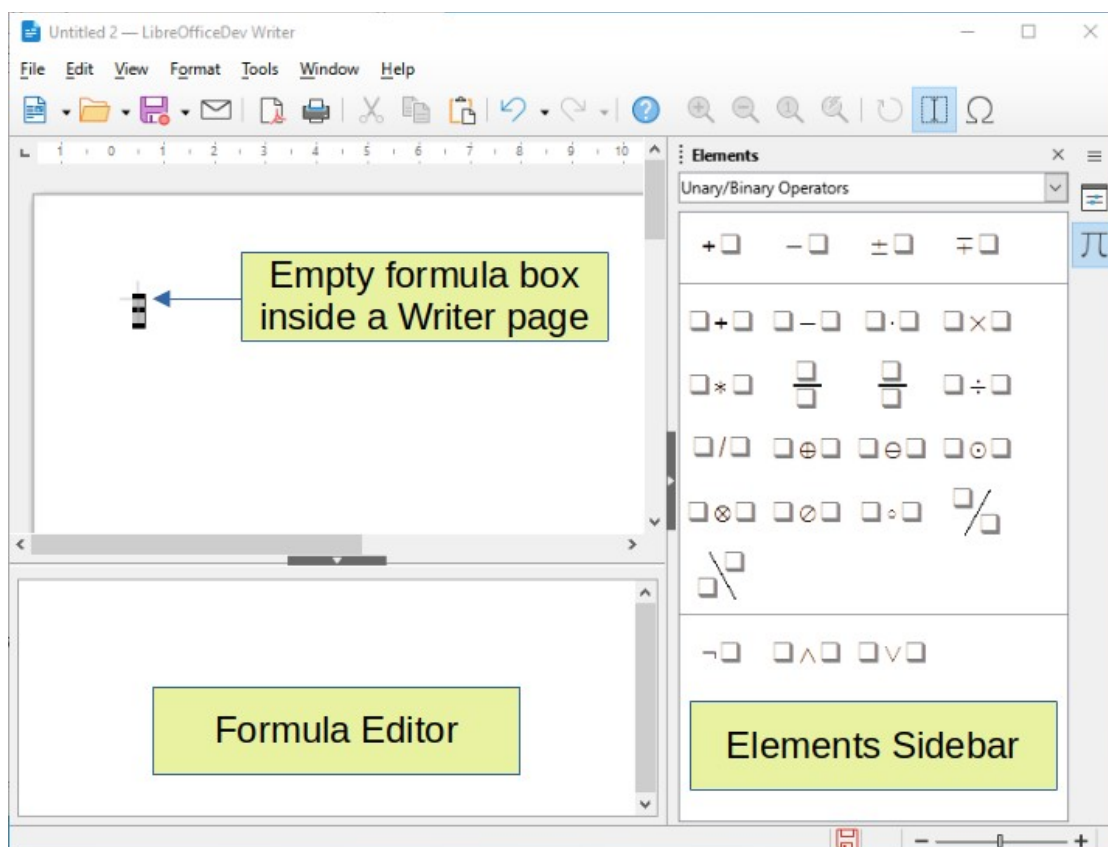

Figure 302: Empty formula in a Writer document

If you need to insert formulas frequently, you should add the Formula button to the Standard toolbar or create a keyboard shortcut. See “Customization” below for more information.

Creating formulas

You can create a formula with one of the following methods:

- Go to the Elements panel, select a category in the drop-down list, then select a symbol.
- Right-click in the Formula Editor and select a category, then select a symbol in the context menu.
- Enter markup language directly into the Formula Editor.

Note

Using the Elements panel or the context menus to create a formula provides a convenient way to learn the markup language used by Math.

Tip

When using the Elements panel, you ought to select *Extended tips* in LibreOffice Options. This will help you to identify the categories and symbols that need to be used in the formula. Go to **Tools > Options > LibreOffice > General** on the Menu bar and select **Extended tips** in the *Help* section.

Elements panel

The Elements panel (Figure 301) is a visual tool to help create and edit formulas. It organizes mathematical symbols and operators using categories in a drop-down list. The steps below describe how to enable the Elements panel and navigate its categories and symbols.

- 1) Go to **View > Elements** on the Menu bar to open the Elements panel.
- 2) Select the category for the formula from the drop-down list at the top of the Elements panel.
- 3) Select the symbol for the formula in the Elements panel. The symbols that are available change according to the selected category.
- 4) After choosing one of the symbols in the Elements panel, the Formula Editor will be updated with the Markup notation of the selected symbol.

Note

The Elements panel can either be a floating dialog, as shown in Figure 301, or positioned to the right of the Formula Editor, as shown in Figure 302.

Tip

The Elements panel includes an Examples category, which provides example formulas to use as a starting point for a formula or equation.

Context menu

The Formula Editor also provides a context menu which allows users to access categories and symbols while they are creating formulas. To open the context menu, right-click in the Formula Editor. Then select a category and select the markup example for use in the sub-context menu. An example is shown in Figure 303.

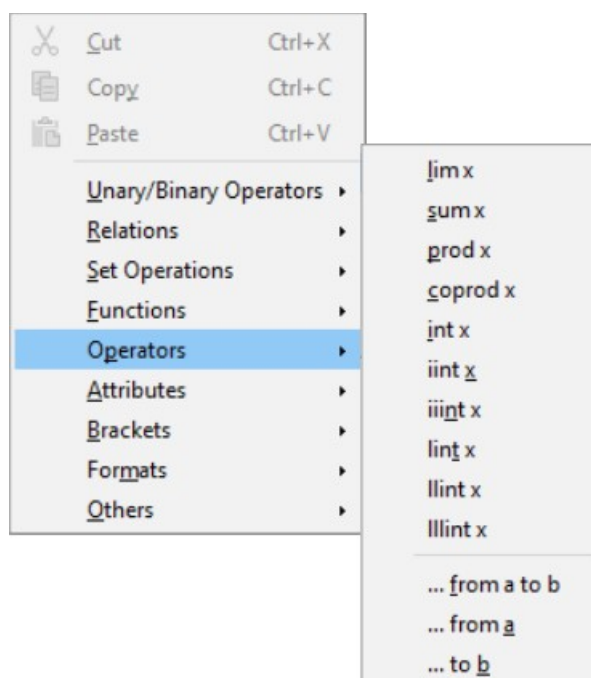

Figure 303: Context menu in Formula Editor

Note

The Elements panel and the context menu only contain the commands that are most commonly used in formulas. If a symbol or a command is not listed in the Elements panel and context menu, you must insert it manually with the markup language. For a complete list of commands and symbols available in Math, see Appendix A, Commands Reference, in the *Math Guide*.

Markup language

Markup language is entered directly into the Formula Editor. For example, typing `5 times 4` into the Formula Editor creates the simple formula 5×4 . For experienced markup language users, it can be the quickest way to enter a formula. Table 14 shows some examples of using markup language to enter commands. For a full list of commands that can be used in the Formula Editor, see Appendix A, Commands Reference, in the *Math Guide*.

Table 14: Example commands using markup language

Display	Command	Display	Command
$a=b$	<code>a = b</code>	\sqrt{a}	<code>sqrt {a}</code>
a^2	<code>a^2</code>	a_n	<code>a_n</code>
$\int f(x) dx$	<code>int f(x) dx</code>	$\sum a_n$	<code>sum a_n</code>
$a \leq b$	<code>a <= b</code>	∞	<code>infinity</code>
$a \times b$	<code>a times b</code>	$x \cdot y$	<code>x cdot y</code>

Greek characters

Using markup language

Greek characters are commonly used in formulas, but they cannot be entered into a formula with the Elements panel or the context menu. When entering Greek characters into a formula, use the English names of Greek characters in the markup language. See Appendix A, Commands Reference, in the *Math Guide* for a list of Greek characters that can be entered using markup language.

- For a lowercase Greek character, type a percentage % sign, then type the character name in lowercase using the English name. For example, typing `%lambda` creates the Greek character λ .
- For an UPPERCASE Greek character, type a percentage % sign, then type the character name in UPPERCASE using the English name. For example, typing `%LAMBDA` creates the Greek character Λ .
- For an *italic* Greek character, type a percentage % sign followed by the *i* character, then the English name of the Greek character in lower or UPPER case. For example, typing `%iTHETA` creates the *italic* Greek character Θ .

Symbols dialog

Greek characters can also be entered into a formula using the Symbols dialog.

- 1) Make sure the cursor is in the correct position in the Formula Editor.
- 2) Go to **Tools > Symbols** on the Menu bar, or click the **Symbols** icon in the Tools toolbar, to open the Symbols dialog (Figure 304).
- 3) Select *Greek* in the *Symbol set* drop-down list. For *italic* characters, select *iGreek* in the drop-down list.

- 4) Double-click the desired Greek character to insert it or select it and click **Insert**. When selected, the name of the character is shown below the symbol list.
- 5) Click **Close** after entering Greek characters into the formula.

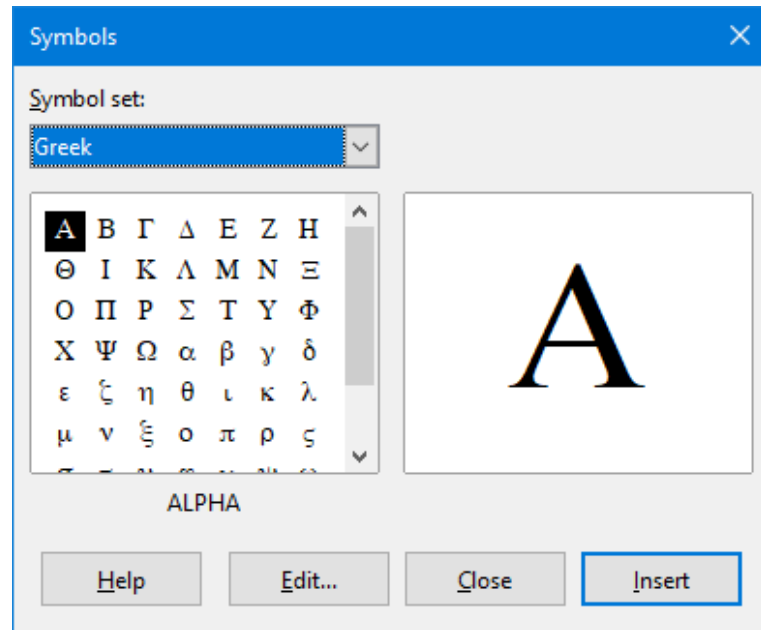

Figure 304: Symbols dialog

Special characters

In addition to math symbols, special characters can also be part of a formula expression. The special characters are handled as text in the formula.

- 1) Make sure the cursor is in the correct position in the Formula Editor.
- 2) Go to **Tools > Special Characters** on the menu bar
- 3) Select the **Font** and **Character block** in the upper drop-down list box,
- 4) Select the character in the grid
- 5) Double-click on the character or select and press **Insert**.

Formula examples

Example 1

The simple formula 5×4 can be created using LibreOffice Math by performing the following steps:

- 1) Make sure the cursor is flashing in the Formula Editor, then select the category **Unary/Binary Operators** and symbol **Multiplication** using one of the following methods:
- 2) Go to the Elements panel, select **Unary/Binary Operators** in the drop-down list, and then select the **Multiplication** icon $\square \times \square$.
 - Right-click in the Formula Editor and select **Unary/Binary Operators > a times b** in the context menu.
 - Using markup language, enter `5 times 4` in the Formula Editor.

The first two methods place the formula text `<?> times <?>` in the Formula Editor and the symbol $\square \times \square$ appears in the document. For the third method, using markup

language in the Formula Editor places the formula 5×4 directly into the document and there is no need to carry out steps two or three.

- 3) Select the first placeholder `<?>` before the word `times` in the Formula Editor and replace it with the character `5`. The formula in the document updates automatically.
- 4) Select the second placeholder `<?>` after the word `times` in the Formula Editor and replace it with the character `4`. The formula in the document updates automatically.



Tip

To move forward from one placeholder to the next placeholder in a formula, press the *F4* key. To move backward from one placeholder to the previous placeholder in a formula, use the key combination *Shift+F4*.



Note

If necessary, to prevent a formula in a document from updating automatically. Go to **View** on the Menu bar and deselect **AutoUpdate display**. To then manually update a formula, press the *F9* key or select **View > Update** on the Menu bar.

Example 2

To create the formula $\pi \simeq 3.14159$ where the value of pi is rounded to 5 decimal places, without knowing markup associated with the **Is Similar Or Equal** symbol \simeq , follow these steps:

- 1) Make sure the cursor is flashing in the Formula Editor.
- 2) Enter `%pi` in the Formula Editor to enter the Greek character for pi (π).
- 3) Select the category **Relations** and symbol **Is Similar Or Equal** using one of the following methods:
 - In the Elements panel, select **Relations** in the drop-down list and then select the **Is Similar Or Equal** icon $\square \simeq \square$.
 - Right-click in the Formula Editor and select **Relations > a simeq b** in the context menu.
- 4) Delete the first placeholder `<?>` before the word `simeq` in the Formula Editor.
- 5) Select the second placeholder `<?>` after the word `simeq` in the Formula Editor and replace it with the characters `3.14159`. The formula $\pi \simeq 3.14159$ now appears in the document.

Editing formulas

If you need to edit a formula, the approach differs depending on whether the formula is in Math or another LibreOffice component.

- 1) In Math, double-click on a formula element in the formula that appears in the Preview window to select the formula element in the Formula Editor, or directly select a formula element in the Formula Editor.
- 2) In Writer, Calc, Impress, or Draw, double-click on the formula, or right-click on the formula and select **Edit** in the context menu, to open the Formula Editor and enter editing mode. The cursor is positioned at the start of the formula in the Formula Editor.

Note

If a formula element cannot be selected using the cursor, click on the **Formula Cursor** icon in the Tools toolbar to activate the formula cursor.

- 3) Select the formula element to be changed with one of the following methods:
 - Click on the formula element in the Preview window, position the cursor at the beginning of the formula element in the Formula Editor, then select the formula element in the Formula Editor.
 - Double-click on the formula element in the Preview window to select the formula element in the Formula Editor.
 - Position the cursor in the Formula Editor at the formula element to be edited, then select that formula element.
 - Double-click directly on the formula element in the Formula Editor to select it.
- 4) Make changes to the selected formula element.
- 5) Go to **View > Update** on the Menu bar, or press the *F9* key, or click on the **Update** icon on the Tools toolbar to update the formula in the Preview window or in the document.
- 6) In Math, save changes to the formula after editing.
- 7) In Writer, Calc, Impress, or Draw, click anywhere in the document away from the formula to leave editing mode, then save the document to save changes to the formula.

Formula layout

This section discusses how to lay out complex formulas in Math or in a LibreOffice document.

Using braces

Since LibreOffice Math knows nothing about order of operations within a formula, braces (curly brackets) are used to define the order of operations. The following examples show how braces can be used in a formula.

Example 1

2 over x + 1 gives the result $\frac{2}{x}+1$

In this example, Math recognizes that the 2 before and the x after the **over** command belongs to the fraction, and has represented them accordingly. If $x+1$ rather than x is going to be the denominator, they must be bracketed together using braces.

Inserting braces into 2 over {x + 1} gives the result $\frac{2}{x+1}$ where $x+1$ is now the denominator.

Example 2

- 1 over 2 gives the result $\frac{-1}{2}$

Math recognizes the minus sign as a prefix for the 1 and has therefore placed it in the numerator of the fraction. To show that the whole fraction is negative, with the minus sign in front of the fraction, the fraction must be put in braces to signify to Math that the characters belong together.

Adding braces into the markup language `- {1 over 2}` gives the result $-\frac{1}{2}$ and the whole fraction is now negative.

Example 3

When braces are used in markup language, they define the layout of the formula and are not displayed or printed. To use braces within a formula, use the commands `\lbrace` and `\rbrace` within the markup language.

`x over {-x + 1}` gives the result $\frac{x}{-x+1}$

Replace the braces using the commands `\lbrace` and `\rbrace` in the markup language.

Write `x over \lbrace -x + 1 \rbrace` and the result is $\frac{x}{\{-x+1\}}$

Brackets (parentheses) and matrices

To use a matrix in a formula, the `matrix` command must be used. Below is a simple example of a 2 x 2 matrix.

`matrix { a # b ## c # d }` $\begin{matrix} a & b \\ c & d \end{matrix}$

In matrices, rows are separated by two hashes (`##`) and entries within each row are separated by one hash (`#`).

Normally, when brackets are within a matrix, the brackets do not scale as the matrix increases in size. The example below shows a formula where the parentheses do not scale to the size of the resulting matrix.

`(matrix { a # b ## c # d })` $\begin{pmatrix} a & b \\ c & d \end{pmatrix}$

To overcome this problem, Math gives you scalable brackets that grow in size to match the size of the matrix. Use the commands `left(` and `right)` to create scalable brackets around a matrix. The following example shows how to create a matrix with scalable parentheses.

`left(matrix { a # b ## c # d } right)` $\left(\begin{matrix} a & b \\ c & d \end{matrix} \right)$

Scalable brackets can also be used with any element of a formula, such as fraction, square root, and so on.

To create a matrix where some values are empty, use the grave accent (```) so that Math will put a small space in that position, as shown in the example below.

`left(matrix { 1 # 2 # 3 ## 4 # ` # 6 } right)` $\left(\begin{matrix} 1 & 2 & 3 \\ 4 & & 6 \end{matrix} \right)$



Tip

Use the commands `left [` and `right]` to obtain square brackets. A list of all brackets available within Math can be found in Appendix A, Commands Reference, of the *Math Guide*.



Tip

To make all brackets to be scalable, go to **Format > Spacing** on the Menu bar to open the Spacing dialog. Click on **Category**, select *Brackets* in the drop-down list, and then select the option **Scale all brackets**.

Unpaired brackets

When using brackets in a formula, Math expects that for every opening bracket there is a closing one. If there is no closing bracket, Math will place an inverted question mark next to where the closing bracket should be placed. For example, `\lbrace a; b` will result in $\lbrace a; b$ because the right bracket `rbrace` is missing.

This inverted question mark disappears when all the brackets are paired. The previous example could be fixed to `\lbrace a; b \rbrace`, resulting in $\{a; b\}$. However, there are cases where an unpaired bracket is necessary (see below).

Non scalable brackets

When a backslash `\` is placed before a non scalable bracket, it indicates that the subsequent character should not be regarded as a bracket, but rather as a literal character.

For example, the unpaired brackets in the formula `[a; b [` would result in an inverted question mark because Math expects that `[` will be closed by `]`. To fix the error, use the backslash and insert `\ [a; b \ [` into the Formula Editor to obtain $[a;b[$ as the result.

Scalable brackets

To create unpaired scalable brackets or braces in a formula, the markup commands `left`, `right`, and `none` can be used.

Example

The following formula uses the `stack` command to create a two-line formula and adds a bracket only to the right side of the stack.

```
abs x = left \lbrace stack {x "for" x >= 0 # -x
"for" x < 0} right none
```

$$|x| = \begin{cases} x & \text{for } x \geq 0 \\ -x & \text{for } x < 0 \end{cases}$$

This effect can be achieved by using the `left \lbrace` command combined with the `right none` command. The first command indicates that the left bracket is a `\lbrace` whereas the second command tells Math that the right bracket will be `none`, meaning that no bracket will be added to the right side of the formula.

Recognizing functions

In a basic installation of Math, the software outputs functions in normal characters and variables in italic characters. However, if Math fails to recognize a function, the markup command `func` before a function can force Math to recognize any following text as a function and uses normal characters.

For a full list of functions within Math, see Appendix A, Commands Reference, in the *Math Guide*.

Some Math functions have to be followed by a number or a variable. If these are missing, Math places an inverted question mark where the missing number or variable should be. To remove the inverted question mark and correct the formula, enter a number, a variable, or a pair of empty brackets as a placeholder.



Tip

Use the *F3* key to navigate to the next formula error or the key combination *Shift+F3* to move to the previous error.

Formulas over multiple lines

When a formula requires more than one line, do not press the *Enter* key to create a new line--the markup language in the Formula Editor goes to a new line, but the resulting formula does not have two lines. To add a new line to the formula, you must use the markup command `newline`. The examples below illustrate how the markup command `newline` can be used to add a new line to a formula.

Examples

The first example simply adds an *Enter* to break the line in the markup language, which does not result in adding a new line, while the second example uses the `newline` command and yields a two-line formula.

Markup Language	Resulting Formula
<code>x = 3 y = 1</code>	$x=3 y=1$
<code>x = 3 newline y = 1</code>	$x=3y=1$

Math cannot create multiple line formulas when a line ends with an equals sign or continue the formula on a new line without completing the term on the right side of the equals sign. If a multiple line formula needs to have an equals sign at the end of a line without a term after the equals sign, then use either empty quotes "" or empty braces {} or the space characters grave ` or tilde ~.

By default, a multiple line formula is center aligned. For more information on alignment using the equals sign, see "Customization" below.

Spacing within formulas

If you need spacing between the elements in a formula, they are not set by using space characters in the markup language. To add spaces into a formula, use one of the following options:

- The grave ` to add a small space.
- The tilde ~ for a large space.
- Add space characters between quotes ". These spaces will be considered as text.

Any spaces at the end of a line in the markup language are ignored by default.

For more information, see "Adjusting formula spacing" below.

Adding limits to sum/integral commands

The `sum` and `int` commands, which are used for summations and integrals respectively, can use the parameters, `from` and `to`, to set the lower and upper limits. The parameters `from` and `to` can be used singly or together as shown by the examples seen below.

For more information on the sum and integral commands, see Appendix A, Commands Reference, in the *Math Guide*.

Examples

Here are some examples of how to add upper and lower bounds to summations and integrals. Note that brackets can be used to explicitly define which parts of the formula correspond to the desired bounds.

Markup Language	Resulting Formula
<code>sum from k = 1 to n a_k</code>	$\sum_{k=1}^n a_k$
<code>sum to infinity 2^{-n}</code>	$\sum_{n=1}^{\infty} 2^{-n}$
<code>sum from{ i=1 } to{ n } sum from{ j=1; i < j } to{ m } x_ij</code>	$\sum_{i=1}^n \sum_{j=1; i < j}^m x_{ij}$
<code>int from 0 to x f(t) dt</code>	$\int_0^x f(t) dt$
<code>int_0^x f(t) dt</code>	$\int_0^x f(t) dt$
<code>int from Re f</code>	$\int_{\Re} f$

Writing derivatives

When writing derivatives, use the `over` command to identify fractions to Math. The `over` command combined with the character `d` for a total derivative or the `partial` command for a partial derivative to achieve the effect of a derivative. Braces `{ }` are used in each side of the elements to surround them and make the derivative, as shown by the following examples.

Examples

Below are a few examples of using Math to write derivatives.

Markup Language	Resulting Formula
<code>{df} over {dx}</code>	$\frac{df}{dx}$
<code>{partial f} over {partial y}</code>	$\frac{\partial f}{\partial y}$
<code>{partial^2 f} over {partial t^2}</code>	$\frac{\partial^2 f}{\partial t^2}$

Note

To write function names with primes, as is normal in school notation, first add the symbols to the catalog. See “Catalog customization” below for more information.

Markup language characters as normal characters

Characters that are used as controls in markup language cannot be entered directly as normal characters. These characters are: %, {, }, &, |, _, ^ and ". For example, $2\% = 0.02$ in markup language will not appear in the formula with the same characters. To overcome this limitation in markup language, use one of the following methods:

- Use double quotes to mark that character as text, for example $2\% = 0.02$ will appear in a formula as $2\% = 0.02$. However, this method cannot be used for the double-quote character itself, see “Text in formulas” below.
- Add the character to the Math Catalog, for example the double quote character.
- Use commands, for example `\lbrace` and `rbrace` provide literal braces $\{ \}$.

Note

The Special Characters dialog used by other LibreOffice components is not available in Math. For regular use of special characters in Math, adding the characters to the Math Catalog is recommended; see “Catalog customization” below for more information.

Text in formulas

To include text in a formula, enclose any text in double-quotes, for example: x " for " $x \geq 0$ in markup language will create the formula x for $x \geq 0$. All characters, except double quotes, can be used in text.

However, if you need double quotes in formula text, create the text with double quotes in LibreOffice Writer, then copy and paste the text into the Formula Editor, as shown in Figure 305.

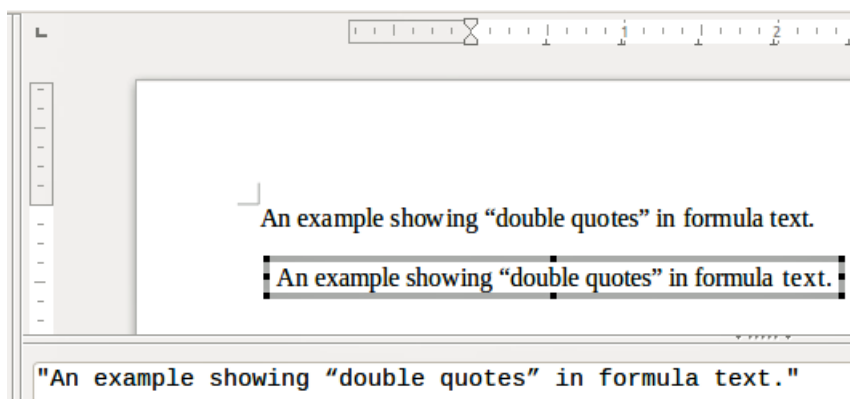

Figure 305: Example of double quotes in formula text

The font used for text in a formula will be the default font that has been set in the Fonts dialog. For more information on how to change fonts used for in formulas, see “Changing formula appearance” below.

By default, text alignment is left-justified in formulas. For more information on how to change text alignment, see “Adjusting formula alignment” below.

Formatting text in formulas

Formatting commands are not interpreted within text used in formulas. To use formatting commands within formula text, using double quotes to break up the text in the Formula Editor.

Example

Enter the following in the Formula Editor:

"In " color blue bold "isosceles" "triangles, the base angles are equal"

creates the following text in a formula In **isosceles** triangles, the base angles are equal .

This example shows how to use the markup commands `color` and `bold` to format the word "isosceles". Note that the commands are applied to the text within double quotes so the formatting commands do not apply to the remainder of the text in the example because it is in a separate quote block.

The command `color` needs to be followed by the name of the desired color or to its RGB or hexadecimal value. Refer to Appendix A, Command Reference, in the *Math Guide* for a list of predefined color names.

Aligning formulas using equals sign

LibreOffice Math does not have a command for aligning formulas on a particular character. However, a matrix can align formulas on a character and this character is normally the equals sign (=). In addition, the markup commands `alignr`, `alignl` and `alignc` can set the alignment of each value inside the matrix to the right, left or center, respectively.

Example

The example below uses a matrix to align formulas on the equals sign. Notice how the alignment commands align the contents of each position in the matrix.

```
matrix{ alignr x+y # {}={ } # alignl 2 ## alignr      x+y = 2  
x # {}={ } # alignl 2-y }                          x = 2-y
```

Note

The empty braces each side of the equals sign are necessary because the equals sign is a binary operator and requires an expression on each side. Spaces, or ``` or `~` characters each side of the equals sign can be used, but braces are recommended as they are easier to see within the markup language.

The spacing on each side of the equals sign can be reduced by changing the inter-column spacing of the matrix. See "Adjusting formula spacing" below for more information.

Changing formula appearance

This section describes how to change the font or font size in a selected formula and change the default font or font size.

Note

Only formulas inserted after the change in font settings will use the new default settings. Previously inserted formulas would have to be updated individually to match the same font settings as the new default settings.

Tip

The extension "Formatting of all Math formulas" allows users to change the font name and font size for all or only selected formulas in a document. For more information, go to this URL:

<https://extensions.libreoffice.org/en/extensions/show/formatting-of-all-math-formulas>

The Properties panel in the sidebar

This very simple panel contains allows you to set fonts, fonts sizes, spacing and the alignment of formulas (Figure 306).

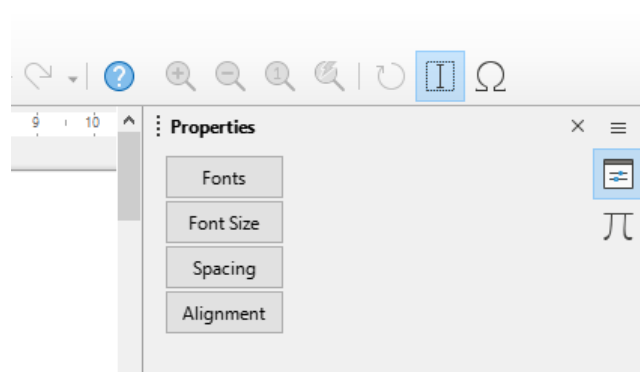

Figure 306: Properties panel on the sidebar

Formula font size

Current formula font size

To change the font size used for a formula already inserted in Math or another LibreOffice component, follow these steps:

- 1) Click on the markup language in the Formula Editor.
- 2) Go to **Format > Font size** on the Menu bar or click on the **Font Size** button on the sidebar to open the Font Sizes dialog (Figure 307).
- 3) Select a different font size using the *Base size* spinner or type a new font size in the *Base Size* box.
- 4) Click **OK** to save changes and close the dialog. An example result when the font size is changed is shown below.

Example

Default font size 12pt: $\pi \approx 3.14159$

After font size change to 18pt: $\pi \approx 3.14159$

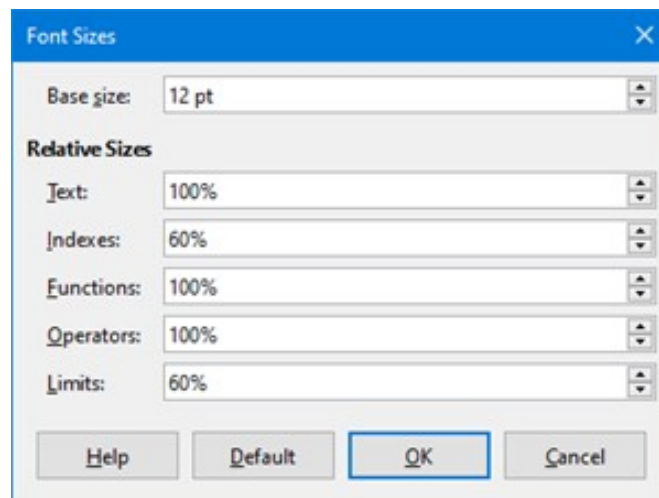

Figure 307: Font Sizes dialog

Default formula font size

To change the default font size used for all formulas in Math or another LibreOffice component, do the following:

- 1) Before inserting any formulas into a document, go to **Format > Font size** on the Menu bar or click on the **Font Size** button on the sidebar to open the Font Sizes dialog (Figure 307).
- 2) Select a different font size using the *Base size* spinner or type a new font size in the *Base size* box.
- 3) Click **Default** and confirm the changes to the base size font. Any formulas created from this point on will use the new base size font for formulas.
- 4) Click **OK** to save changes and close the Font Sizes dialog.

Font size options

The Font Sizes dialog (Figure 307) specifies the font sizes for a formula. When you select a base size, all elements of the formula will be scaled in relation to this base.

- **Base size** – all elements of a formula are proportionally scaled to the base size. To change the base size, select or type in the desired point (pt) size. Other units of measure or other metrics can also be automatically converted to points. For example, entering 1in or 1”, Math converts the value to 72 pt.
- **Relative Sizes** – in this section, determine the relative sizes for each type of element with reference to the base size.
- **Default** – click this button to save any changes as a default for all new formulas. A confirmation message appears.

Formula fonts

The default Math font in LibreOffice is OpenSymbol. However you can change the fonts used in formulas.

Change current formula fonts

To change the fonts used for the current formula in Math or another LibreOffice component:

- 1) Click in the markup language in the Formula Editor.
- 2) Go to **Format > Fonts** on the Menu bar or click on the **Fonts** button on the sidebar to open the Fonts dialog (Figure 308).
- 3) Select a new font for each of the various options in the drop-down lists.
- 4) If the desired font is not in the drop-down list, click **Modify** and select the option in the context menu to open a fonts dialog. Select the desired font and click **OK** to add it to the drop-down list for that option.
- 5) Click **OK** to save changes and close the Fonts dialog.

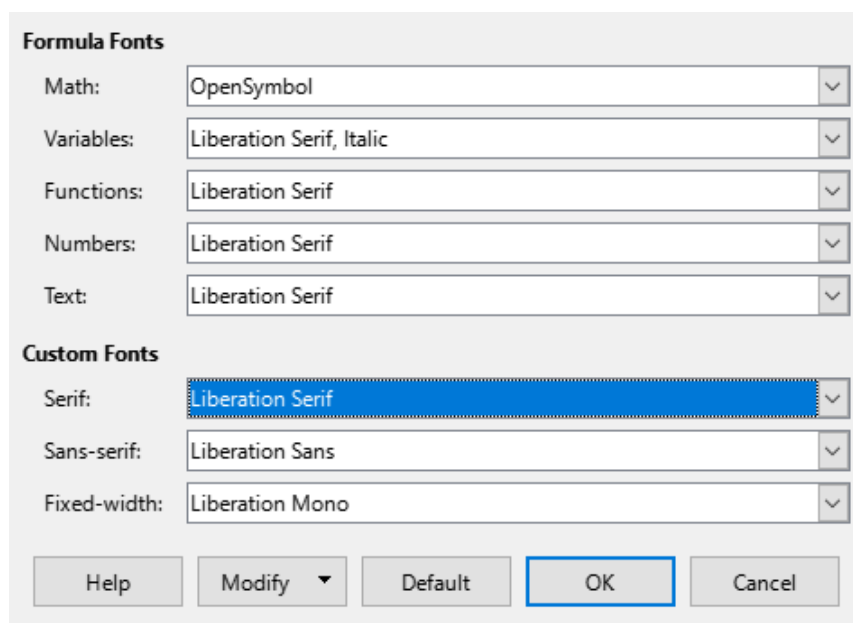

Figure 308: Fonts dialog

Change default formula fonts

To change the default fonts used in all formulas in Math or other LibreOffice components, perform the following steps

- 1) Before inserting any formulas in a document, go to **Format > Fonts** on the Menu bar or click on the **Fonts** button on the sidebar to open the Fonts dialog (Figure 308).
- 2) Select a new font for each of the various options in the drop-down lists.
- 3) If the desired font is not in the drop-down list, click **Modify** and select the option in the context menu to open a fonts dialog. Select a font, and click **OK** to add it to the drop-down list for that option.
- 4) Click **Default** and confirm changes to the fonts. Any formulas created from this point on will use the new font for formulas.
- 5) Click **OK** to save changes and close the Fonts dialog.

Define formula font options

These options define the fonts that can be applied to formula elements.

- **Formula Fonts** – defines the fonts used for the variables, functions, numbers and inserted text that form the elements of a formula.
- **Custom Fonts** – in this section of the Fonts dialog (Figure 308), fonts are defined which format other text components in a formula. The three basic fonts Serif, Sans, and Fixed are available. Other fonts can be added to each standard installed basic font using the **Modify** button. Every font installed on a computer system is available for use.
- **Modify** – click one of the options in the drop-down menu to access the Fonts dialog, where the font and attributes can be defined for the respective formula and for custom fonts.
- **Default** – click this button to save any changes as a default for all new formulas. A confirmation message appears.

Note

When a new font is selected for a formula, the old font remains in the list alongside the new one and can be selected again.

Note

Variables should be written in *italics*, so make sure that the *Italic* option is selected for the desired font. For all other elements, use the basic form of a font. The style can be easily altered in the formula itself by using the commands `italic` or `bold` to set these characteristics and `nitalic` or `nbold` to unset them.

Adjusting formula spacing

Use the Spacing dialog (Figure 309) to determine the spacing between formula elements. The spacing is specified as a percentage in relation to the defined base size for font sizes.

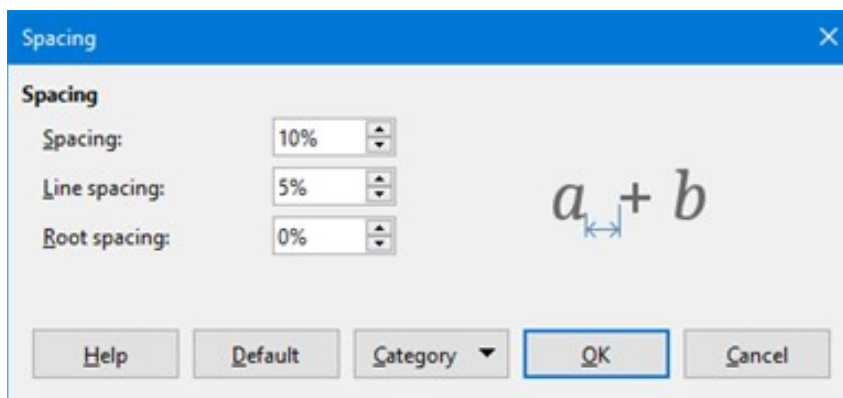

Figure 309: Spacing dialog

Change current formula spacing

To change the spacing used for the current formula in Math or another LibreOffice component do the following:

- 1) Click in the markup language in the Formula Editor.
- 2) Go to **Format > Spacing** on the Menu bar or click on the **Spacing** button on the sidebar to open the Spacing dialog (Figure 309).
- 3) Click **Category** and select one of the options in the drop-down list. The options in the Spacing dialog change according to the category selected.
- 4) Enter new values for the spacing category and click **OK**.
- 5) Check the result in the formula.

Modify default formula spacing

To change the default spacing used for all formulas in Math or another LibreOffice component, do the following:

- 1) Before inserting any formulas into a document, go to **Format > Spacing** on the Menu bar or click on the **Spacing** button on the sidebar to open the Spacing dialog (Figure 309).
- 2) Click **Category** and select one of the options in the drop-down list. The options in the Spacing dialog change according to the category selected.
- 3) Enter new values for the spacing category.

- 4) Click **Default** and confirm changes to the formula spacing. Any formulas created from this point on will use the new spacing for formulas.
- 5) Click **OK** to save changes and close the Spacing dialog.

Note

Only formulas inserted after the change in default spacing will use the new default settings. Formulas that were inserted before the change will need to be updated to match the same spacing as the new default settings.

Change spacing options

To determine the formula element to be updated, employ the Use Category in the Spacing dialog (Figure 309). The appearance of the dialog depends on the chosen category. A preview window shows which spacing is modified through the respective boxes.

- **Category** – defines the selection for the spacing change.
- **Spacing** – defines the spacing between variables and operators, between lines, and between root signs and radicals.
- **Indexes** – defines the spacing for superscript and subscript indexes.
- **Fractions** – defines the spacing between the fraction bar and the numerator or denominator.
- **Fraction Bars** – defines the excess length and line weight of the fraction bar.
- **Limits** – defines the spacing between the sum symbol and the limit conditions.
- **Brackets** – defines the spacing between brackets and the content.
 - *Excess size (left/right)* – determines the vertical distance between the upper edge of the contents and the upper end of the brackets.
 - *Spacing* – determines the horizontal distance between the contents and the upper end of the brackets.
 - *Scale all brackets* – scales all types of brackets. By entering (a over b) in the Formula Editor, the brackets will surround the whole height of the argument. Normally, this is done by entering left (a over b right).
 - *Excess size* – adjusts the percentage excess size. At 0% the brackets are set so that they surround the argument at the same height. The higher the entered value is, the larger the vertical gap between the contents of the brackets and the external border of the brackets. The field can only be used in combination with *Scale all brackets*.
- **Matrices** – defines the relative spacing for the elements in a matrix.
 - *Line spacing* – determines the spacing between matrix elements in a row.
 - *Column spacing* – determines the spacing between matrix elements in a column.
- **Symbols** – defines the spacing of symbols in relation to variables
 - *Primary height* – defines the height of the symbols in relation to the baseline.
 - *Minimum spacing* – determines the minimum distance between a symbol and variable.
- **Operators** – defines the spacing between operators and variables or numbers.
 - *Excess size* – determines the height from the variable to the operator upper edge.
 - *Spacing* – determines the horizontal distance between operators and variables.

- **Borders** – adds a border to a formula. This option is particularly useful for integrating the formula into a text file in Writer. When making settings, be sure to not use 0 as a size as this creates viewing problems for text that surrounds the insertion point.
- **Preview Field** – displays a preview of the current selection.
- **Default** – saves any changes as default settings for all new formulas. A confirmation dialog will appear before saving these changes.

Adjusting formula alignment

To determine how formula elements located above one another are aligned horizontally relative to each other, use the alignment settings.

Note

It is not possible to align formulas on a particular character and formula alignment does not apply to text elements. Text elements are always aligned left.

Note

Independent of using formula alignment given below, it is possible to align formulas using the commands `alignl`, `alignc` and `alignr`. These commands also work for text elements.

Current formula alignment

To change the alignment used for the current formula in Math or another LibreOffice component:

- 1) Click in the markup language in the Formula Editor.
- 2) Go to **Format > Alignment** on the Menu bar or click on the **Alignment** button on the sidebar to open the Alignment dialog (Figure 310).
- 3) Select either *Left*, *Centered*, or *Right* for horizontal alignment.
- 4) Click **OK** and check the result in the formula.

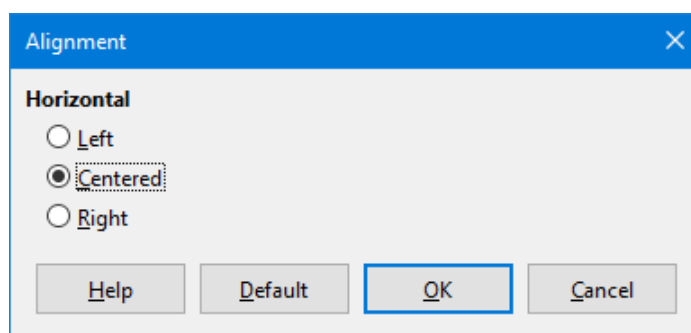

Figure 310: Alignment dialog

Note

Regardless of the alignment option selected in the Alignment dialog, it is possible to align sections of a formula using the commands `alignl`, `alignc` and `alignr`. These commands can align formulas in matrices and work for text elements.

Default formula alignment

To change the default alignment used for all formulas in Math or another LibreOffice component, do the following:

- 1) Before inserting any formulas into a document, go to **Format > Alignment** on the Menu bar or click on the **Alignment** button on the sidebar to open the Alignment dialog (Figure 310).
- 2) Select either *Left*, *Centered*, or *Right* for horizontal alignment.
- 3) Click **Default** and confirm changes to the formula alignment. Any formulas created from this point on will use the new alignment for formulas.
- 4) Click **OK** and check the result in the formula.

Note

Only formulas inserted after the change in default alignment will use the new default settings. Previously inserted formulas would have to be updated individually to match the same alignment as the new default settings.

Changing formula color

The color of characters used in a formula can be changed by using the markup language command `color` followed by a color name, RGB value, or HTML hex value.

This command only works on the formula element immediately after the color name, RGB value, or hex value. For example, entering the markup language `color red 5 times 4` gives the result 5×4 . Note that only the number 5 was colored red.

If you need to change the whole formula's color, use the `color` command and enclose the whole formula within brackets. For example, entering the markup language `color red {5 times 4}` gives the result 5×4 .

Named colors

For information on the named colors available in Math, see Appendix A, Commands Reference, in the *Math Guide*. These colors are listed in the *Attributes* section of the Elements panel (Figure 301 on page 379).

RGB values

To use custom colors defined by RGB (Red, Green and Blue) values ranging from 0 to 255, use the markup command `color rgb R G B`, where R, G, and B correspond to the Red, Green, and Blue values of the desired color.

Example

In this example, the term "decision variable" uses the color defined by the RGB values 160, 82, 45.

```
"Let " x_ij " be a " color rgb 160 82 45 "decision variable " "in the problem under consideration"
```

Math will create the following output:

Let x_{ij} be a **decision variable** in the problem under consideration

Hex values

The `color` command now supports HTML colors as defined by a hex number. Use the `color hex 000000` markup command, where 000000 is the corresponding hex number. For example, the command `color hex FF0000 decision` creates the output *decision*.

Background color

It is not possible to select a background color for formulas in LibreOffice Math. By default, the background color for a formula is will be the same color as the document or frame that the formula has been inserted into. In LibreOffice Writer, you can use object properties to change the background color for a formula. For more information, see “Background and borders” below.

Building a formula library

To reuse formulas, a formula library can be created to contain the formulas created by the Formula Editor. Individual formulas can be saved as separate files using the ODF format for formulas (file type `.odf`), or in MathML format (file type `.mml`).

LibreOffice Math, Writer, Calc, Draw, or Impress can create formulas and allow you to develop a formula library.

Using Math

- 1) Create a file folder to contain the formula library.
- 2) In LibreOffice, go to **File > New > Formula** on the Menu bar, or click on **Math Formula** in the Start Center to open Math and create a formula using the Formula Editor. See “Formulas as separate documents or files” above for more information.
- 3) Go to **File > Save As** on the Menu bar or use the keyboard shortcut *Ctrl+Shift+S* to open a Save As dialog.
- 4) Navigate to the formula library folder created in step 1.
- 5) Name the formula in the *File name* box.
- 6) Select in the *File type* drop-down list either *ODF Formula (.odf)* or *MathML 2.0 (.mml)* as the file type for the formula.
- 7) Click **Save** to save the formula and close the Save As dialog.

Using Writer, Calc, Draw, or Impress

- 1) Create a file folder to contain the formula library.
- 2) Open a document using Writer, Calc, Draw, or Impress.
- 3) Go to **Insert > Object > Formula Object** on the Menu bar to open the Formula Editor and create a formula. See “Formulas in LibreOffice documents” above for more information.
- 4) Right-click on the formula object and select **Save Copy as** in the context menu to open a Save As dialog.
- 5) Navigate to the folder created for the formula library.
- 6) Name the formula in the *File name* box.
- 7) Select in the File type drop-down list either *ODF Formula (.odf)* or *MathML 2.0 (.mml)* as the file type for the formula.
- 8) Click **Save** to save the formula and close the Save As dialog.

Using a formula library

When you need to add a formula from the formula library into a LibreOffice document, it must be inserted as an OLE object. It cannot be added to a document by dragging and dropping using the mouse or by using **Insert > File** on the Menu bar:

- 1) Open the document in Writer, Calc, Draw, or Impress.
- 2) Go to **Insert > Object > OLE Object** on the Menu bar to open the Insert OLE Object dialog.
- 3) Select the option **Create from file**.
- 4) Click **Search** to open a file browser dialog.
- 5) Navigate to the formula library folder.
- 6) Select the formula to be inserted and click **Open**, or double-click on the formula.
- 7) Click **OK** to insert the formula as an OLE object in the document and close the dialog.

Formulas in Writer

When a formula is inserted into a LibreOffice Writer document, the software opens the formula in a frame and treats the formula as an OLE object. To edit it, double-click on an inserted formula and you will open the formula in LibreOffice Math's Formula Editor.

In LibreOffice Writer, the following options are available to change each individual formula within a document. The chapters on styles in the *Writer Guide* have information on how to change the default frame style settings for OLE objects.

Automatic formula numbering in Writer

Only LibreOffice Writer can perform automatic numbering of formulas for cross-reference purposes. The easiest way to add numbered formulas in sequence is to use the AutoText entry **fn** (for 'formula numbered'):

- 1) Start a new line in the document.
- 2) Type *fn* and then press the *F3* key. A two column table with no borders is inserted into the document with the left column containing a sample formula and the right column containing a reference number, as shown below.

$$E = mc^2 \qquad (1)$$

- 3) Delete the sample formula and insert the formula as an object in the left column.
- 4) Alternatively, first insert the formula into the document, then carry out Steps 1 and 2 above replacing the sample formula with another formula.

Cross-referencing with formulas in Writer

- 1) Click in the document where the cross-reference should appear.
- 2) Go to **Insert > Cross-reference** on the Menu bar to open the Fields dialog (Figure 311).
- 3) Click on the *Cross-references* tab, then select **Text** in the *Type* section.
- 4) In the *Selection* section, select the formula number to refer to.
- 5) In the *Insert reference to* section, select **Reference** and click **Insert**.
- 6) After creating the cross-references, click **Close** to close the Fields dialog.

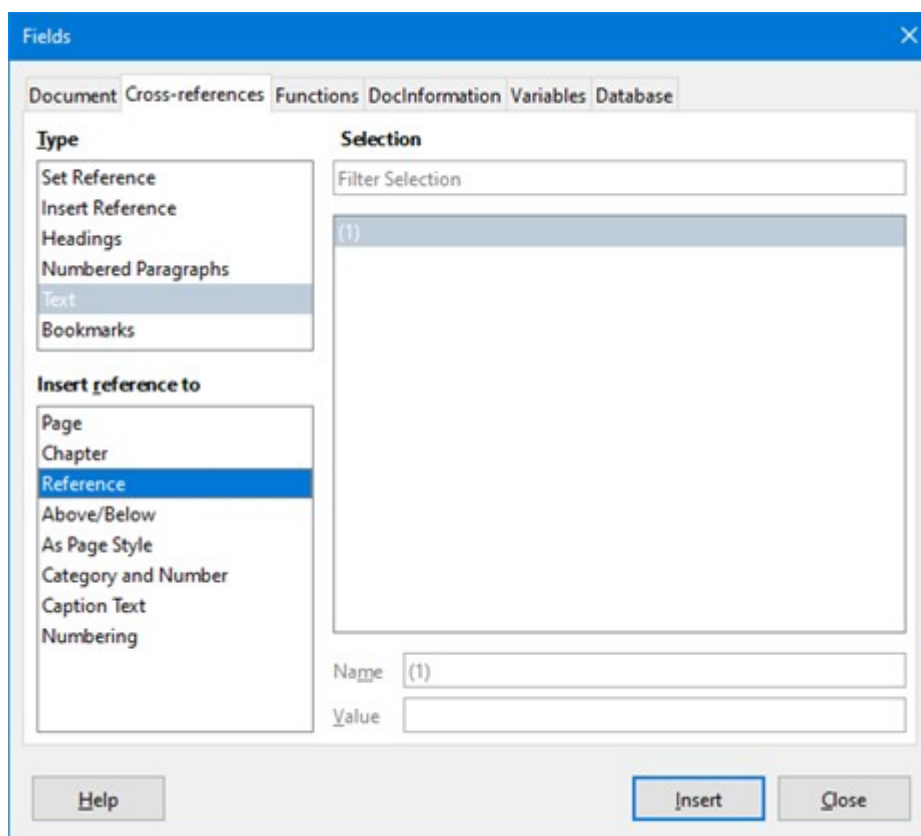

Figure 311: Fields dialog – Cross-references tab

Tip

To insert the cross-reference number without parentheses, select *Numbering* instead of *Reference* in the *Insert reference to* section.

Note

To use square parentheses instead of round ones, or to have the cross-reference number be separated from the formula by tabs instead of using a table, refer to the *Writer Guide*.

Anchoring formulas

A formula is treated as an object within Writer and once inserted, its default anchoring is **To character**. To change the anchoring of a formula object:

- 1) Right-click on the selected formula object and select **Anchor** in the context menu.
- 2) Select a new anchoring option in the context sub-menu. The anchoring positions available are **To Page**, **To Paragraph**, **To Character**, or **As Character**.

Alternatively:

- 1) Right-click on the selected formula object and select **Properties** in the context menu, or go to **Format > Frame and Object > Properties** on the Menu bar, to open the Object dialog (Figure 312).
- 2) On the *Type* tab, select an anchoring position from the *Anchor* section in the upper right.
- 3) Click **OK** to save changes and close the Object dialog.

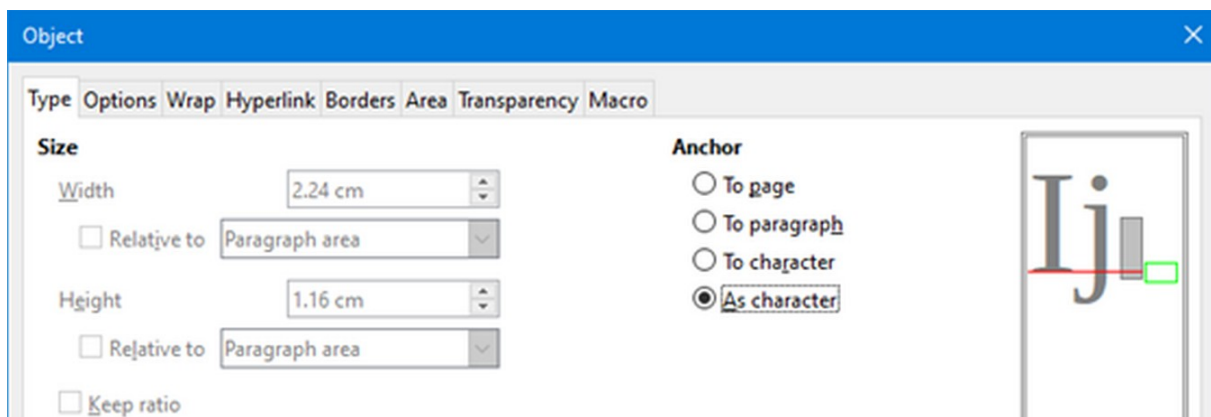

Figure 312: Object dialog – Type tab with Anchor options

Note

When making changes to the options available for frame styles in Writer, anchoring options are not available in the Object dialog. For more information on how to modify frame styles, please refer to the *Writer Guide*.

Vertical alignment

When you are adjusting the vertical alignment of formulas in Writer, the default setting for vertical alignment for formula objects is the text base line. If necessary, the default can be changed by modifying the Formula frame style--see the chapters on styles in the *Writer Guide* for more information.

To change the vertical alignment position of an individual formula object in Writer (assuming that the **As character** anchoring option is selected):

- 1) Right-click on the selected formula object and select **Properties** in the context menu, or go to **Format > Frame and Object > Properties** to open the Object dialog (Figure 312).
- 2) Make sure the *Type* tab is selected and select a new alignment position in the drop-down list in the *Position* section. The vertical alignment options available are **Top**, **Bottom**, **Center**, or **From bottom**.
- 3) If necessary, type in the text box a plus or minus value for vertical alignment. This option is only available if **From bottom** vertical alignment has been selected.
- 4) Select the type of text alignment in the drop-down list in the *Position* section. The text alignment options available are **Base line**, **Character**, and **Row**.
- 5) Click **OK** to save changes and close the Object dialog.

Note

If the **Position** section in the Object dialog is grayed out and not available, then go to **Tools > Options > LibreOffice Writer > Formatting Aids** and uncheck the option **Math baseline alignment**. This setting is stored with the document and applies to all formulas within it. Any new documents created will also use this setting for **Math baseline alignment**.

Object spacing

When a formula object is inserted into a Writer document, LibreOffice gives the formula space along each side of the formula object. The default value used for spacing is set within the frame

style for formula objects and it can be changed by modifying the Formula frame style. See the chapters on styles in the *Writer Guide* for more information.

To individually adjust the spacing for each formula object within a document:

- 1) Create a formula in a Writer document.
- 2) Right-click on the selected formula object and select **Properties** in the context menu, or go to **Format > Frame and Object > Properties** to open the Object dialog.
- 3) Click on the **Wrap** tab to open the Wrap page in the Object dialog (Figure 313).
- 4) In the **Spacing** section, enter the spacing value for *Left*, *Right*, *Top*, and *Bottom* spacing.
- 5) Click **OK** to save the changes and close the Object dialog.

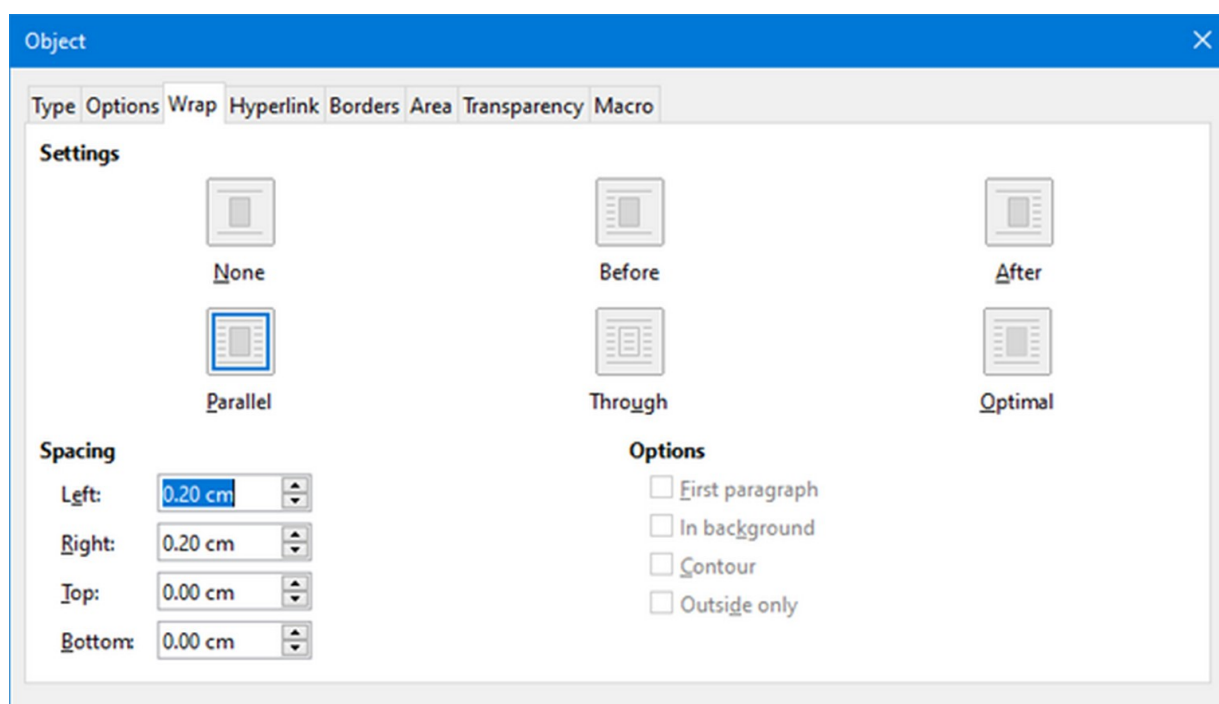

Figure 313: Object dialog – Wrap tab

Text mode

When you place large formulas within a line of text, the formula's elements are often higher than the text height. Therefore, to make large formulas easier to read, you should always insert large formulas into a separate paragraph of their own so that the formula is separated from nearby text.

However, if it is necessary to place a large formula within a line of text, double-click on the formula to open the Formula Editor and then go to **Format > Text Mode** on the Menu bar. The Formula Editor will try to shrink the formula to fit the text height. The numerators and denominators of fractions will be shrunk, and the limits of integrals and sums are placed beside the integral/sum sign, as shown in the following example.

Example

A formula in a separate paragraph:

$$\sum_{i=2}^5 i^2$$

and the same formula embedded into a line of text using text mode format: $\sum_{i=2}^5 i^2$

Background and borders

The default setting for background (area fill) and borders for formula objects is set by the Formula frame style. To change the default setting for the Formula frame style, refer to the chapters on styles in the *Writer Guide*. However, the background and borders can be changed for individual formulas in a document.

Note

When a formula is inserted into a Writer document, the size of its surrounding frame cannot be changed. The frame size for a formula object depends on the setting of the formula font size. See “Formula font size” above for more information.

Backgrounds

- 1) In the document, select the formula for the background change.
- 2) Right-click on the formula and select **Properties** in the context menu, or go to **Format > Frame and Object > Properties** to open the Object dialog.
- 3) Click on the **Area** tab and use the buttons at the top to select the desired type of fill for the formula (Figure 314).
- 4) Select the options for the formula background. The options change depending on the type of fill selected.
- 5) Click **OK** to save changes and close the Object dialog.

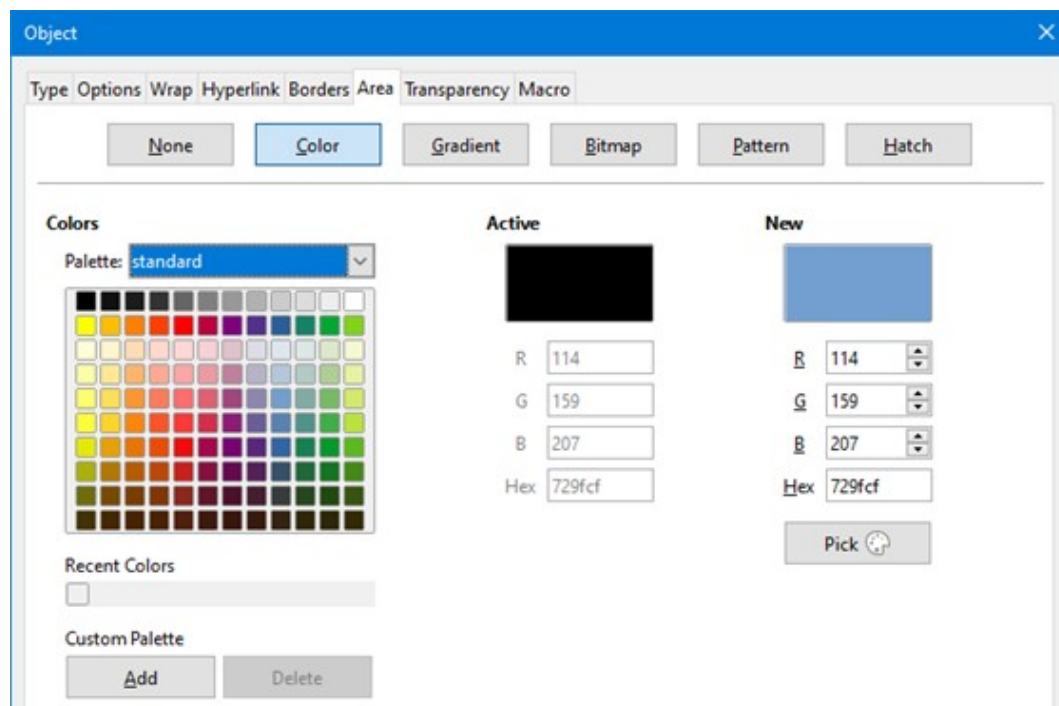

Figure 314: Object dialog – Area tab

Borders

- 1) In the document, select the formula that needs a border change.
- 2) Right-click on the formula and select **Properties** in the context menu, or go to **Format > Frame and Object > Properties** to open the Object dialog.
- 3) Click on the **Borders** tab and select the options for the formula borders (Figure 315).
- 4) Click **OK** to save changes and close the Object dialog.

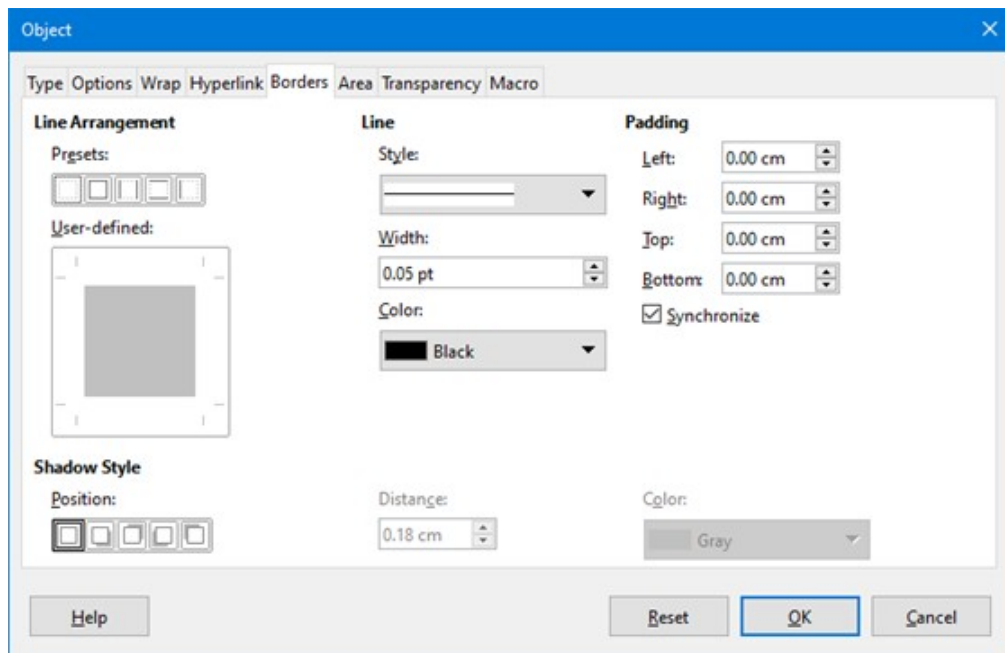

Figure 315: Object dialog – Borders tab

Quick insertion of formulas

To insert formula markup language into a Writer document without opening the Formula Editor:

- 1) Enter the formula markup language into document at the position where it should be placed.
- 2) Select the markup language.
- 3) Go to **Insert > Object** on the Menu bar and select **Formula** Object to create a formula from the selected markup language.
- 4) Alternatively use the key combination *Ctrl* + *Insert* to open the Insert OLE Object dialog and then select **Formula**.

Formulas in Calc, Draw, and Impress

When you insert formulas into Calc, Draw, and Impress, they are inserted as OLE objects without any background (area fill) or borders. Each formula object is inserted into a spreadsheet, drawing, or slide as follows:

- In Calc, formulas are inserted into a selected cell in a spreadsheet with no style assigned to the formula object.
- In Draw and Impress, formulas are inserted into a central position on a drawing or slide and, by default, are assigned the drawing object style *Object with no fill and no line*. For more information on how to modify or assign drawing object styles, see the *Draw Guide* or the *Impress Guide*.

Anchoring formulas in Calc, Draw and Impress

Calc

A formula object can be anchored into a spreadsheet as **To Page** (default setting), or as **To Cell**. To change the anchoring type of formulas in a Calc spreadsheet:

- 1) Select the formula object in the spreadsheet.

- 2) Right-click on the formula and select **Anchor > To Page** or **To Cell** in the context menu.
- 3) Alternatively, go to **Format > Anchor** on the Menu bar and select **To Page** or **To Cell**.



Tip

If an inserted formula in a Calc spreadsheet appears out of scale, fix it by right-clicking the formula object and then selecting the **Original Size** option in the context menu.

Draw and Impress

When a formula is inserted into a drawing or slide, it is inserted as a floating OLE object and is not anchored to any particular position in the drawing or slide.

Formula object properties

The properties of formula objects in Calc, Draw, and Impress can be modified just like any other object that has been placed in a spreadsheet, drawing, or presentation (with the exception of formula object size and the format of any text within a formula). For more information on how to change object properties, see the *Calc Guide*, *Draw Guide* and *Impress Guide*.

The following points will help determine which dialog that you should use to change the properties of a formula object:

- For a formula's background, use the various options in the tabs of the Area dialog.
- For a formula's border, use the various options in the Line dialog. Note that formula borders are separate from cell borders in a Calc spreadsheet.
- To accurately re-position a formula object, use the various options in tabs of the Position and Size dialog.
- In Draw and Impress, formula objects can be arranged, aligned, grouped, flipped, converted, combined, and edited.
- The text attributes of a formula object cannot be changed. The text used in a formula is set when creating the formula in the Formula Editor.
- Formula object size is set by the formula font size when the formula is created in the Formula Editor. The formula object size is protected in the Position and Size dialog, but this can be deselected if desired. However, this is not recommended as resizing a formula object using the Position and Size dialog could lead to distortion of the formula making it difficult to read.

Formulas in charts

A chart in a Calc spreadsheet is itself an OLE object, therefore, the Formula Editor cannot be used to create and insert a formula directly into a chart. However, both the Chart and Math objects can be created separately and later be copied and pasted into the Chart object:

- 1) Create the chart using LibreOffice Calc. For a complete reference on how to create charts, see Chapter 3 in the *Calc Guide*.
- 2) Click at any cell in the spreadsheet so that the Chart is no longer selected.
- 3) Insert a Math Formula object by clicking **Insert > Object > Formula**.
- 4) Type the desired formula into the Formula Editor.
- 5) After editing the formula, select the Math Formula object and press *Ctrl+C* to copy the Formula object to the clipboard.

6) Double-click the chart object to start editing the chart and press *Ctrl+V* to paste the Formula object into the chart.

7) Now the object can be positioned anywhere inside the chart.

To change the formula, repeat the whole process of creating, copying, and pasting the Formula object into the chart.

Chemical formulas

The primary purpose of Math is to create mathematical formulas, but it can also be used to write chemical formulas. However, in chemical formulas, the chemical symbols are normally written in uppercase using non-italic characters.

To create chemical formulas using Math, change the font used for variables to a non-italic font. For more information on how to change fonts in a formula, see “Formula fonts” above.

For reversible reactions in chemical formulas, there is no symbol for a double arrow in Math. With access to a font with correct symbols for use in chemical formulas, these symbols can be added to the Catalog. See “Catalog customization” below for more information.

Customization

This section describes how to customize LibreOffice Math formula creation in LibreOffice documents. Additional information on customizing LibreOffice can be found in Chapter 13, Customizing LibreOffice.

Adding keyboard shortcuts

Keyboard shortcuts can be added to LibreOffice to make creating documents much easier. See Chapter 13, Customizing LibreOffice, for instructions.

Catalog customization

For regular use of a symbol that is not available in Math, add it to the Symbols dialog (Figure 316) by using the Edit Symbols dialog (Figure 317).

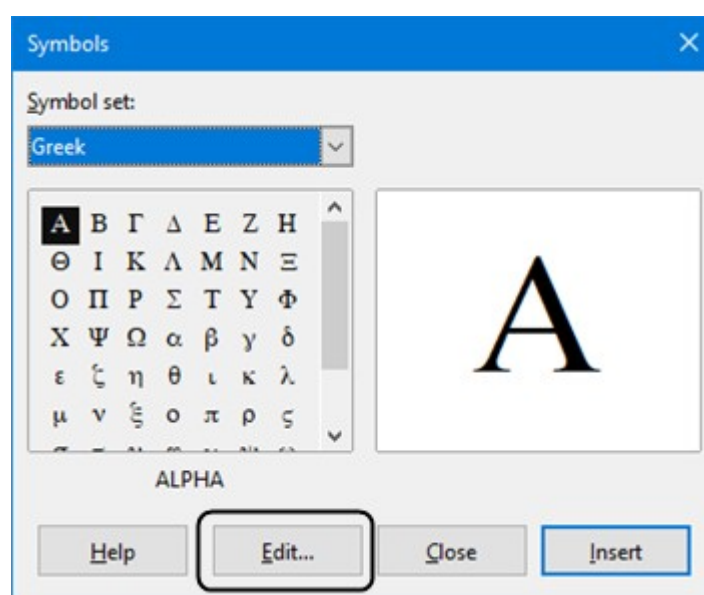

Figure 316: Symbols dialog

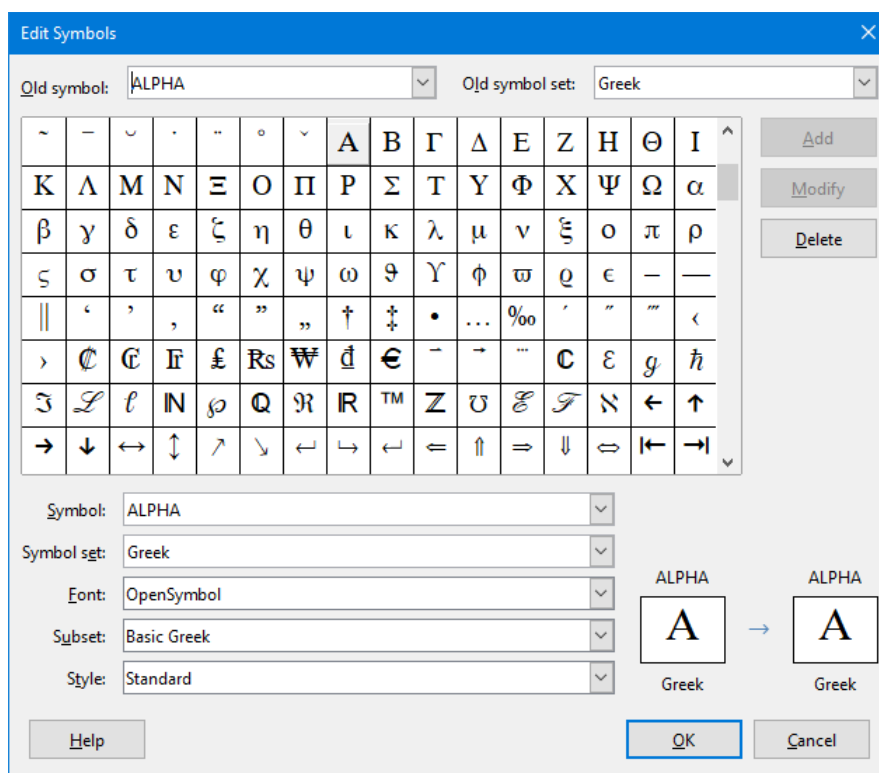

Figure 317: Edit Symbols dialog

In this dialog, symbols can be added to a symbol set, symbol sets can be edited, symbol notations can be modified, new symbol sets can be defined, names can be assigned to symbols, and existing symbol sets modified.

For details of the fields in the Edit Symbols dialog, please refer to the *Math Guide*.

Adding symbols

- 1) Go to **Tools > Symbols** on the Menu bar or click on the **Symbols** icon on the Tools toolbar to open the Symbols dialog.
- 2) Click the **Edit** button to open the Edit Symbols dialog.
- 3) Select a font in the *Font* drop-down list.
- 4) Scroll down and select a symbol character to be added in the preview box. The small right preview box displays the new symbol.
- 5) In the *Symbol* box, locate the symbol that will be added.
- 6) In the *Symbol set* box, select a symbol set in the drop-down list to add the new symbol to, or type a new name to create a new symbol set for the new symbol.
- 7) If required, select a font style in the *Style* drop-down list – **Standard**, **Italic**, **Bold**, or **Bold, Italic**.
- 8) Click **Add**, then click **OK** to close the Edit Symbols dialog. The new symbol and, if created, new symbol set are now available for use.

Note

After a new symbol is added to the catalog, it can be added to a new formula by typing a percentage sign (%) followed by the new name into the markup language. Remember that symbol names are case sensitive, for example, %prime is a different symbol to %Prime.

 **Note**

By default, only those user-defined symbols in the document are stored with it and they are only available in that document. If necessary, you can embed all user-defined symbols, so that when the document is transferred to another computer it can be edited by another person. Go to **Tools > Options > LibreOffice Math > Settings** on the Menu bar and uncheck **Embed only used symbols (smaller file size)** in the *Miscellaneous Options* section.

Editing symbols

Modifying symbol names

To change the name of a symbol:

- 1) In the Edit Symbols dialog (Figure 317), select the symbol name to be changed in the *Old symbol* drop-down list. The symbol appears in the left preview pane at the bottom of the Edit Symbols dialog (Figure 317).
- 2) Type a new name for the symbol in the *Symbol* text box, or select a new name in the *Symbol* drop-down list. The new symbol name appears above the right preview pane at the bottom of the Edit Symbols dialog.
- 3) Click **Modify** and the symbol name is changed.
- 4) Click **OK** to close the Edit Symbols dialog.

Moving symbols

To move a symbol from one symbol set to another:

- 1) In the Edit Symbols dialog (Figure 317), in the *Old symbol set* drop-down list, select the symbol set where the symbol to be moved is located.
- 2) Select the symbol name to be moved in the *Old symbol* drop-down list. The symbol appears in the left preview pane at the bottom of the Edit Symbols dialog (Figure 317).
- 3) In the **Symbol set** drop-down list, select the desired symbol set to move the symbol to. The new symbol set name appears below the right preview pane at the bottom of the Edit Symbols dialog.
- 4) Click **Modify** and the symbol is moved to the new symbol set.
- 5) Click **OK** to close the Edit Symbols dialog.

Deleting symbols

To delete a symbol from a symbol set:

- 1) In the Edit Symbols dialog (Figure 317), in the *Old symbol set* drop-down list, select the symbol set from which the symbol should be deleted.
- 2) Select the symbol name to be deleted in the *Old symbol* drop-down list. The symbol appears in the left preview pane at the bottom of the Edit Symbols dialog (Figure 317).
- 3) Click **Delete** and the symbol is deleted from the symbol set without any confirmation.
- 4) Click **OK** to close the Edit Symbols dialog.

 **Note**

The only way to delete a symbol set is by deleting all of the symbols in that set. When the last symbol is deleted from a set, the set is also deleted.

Formula spacing

If you need to modify a formula's spacing, the grave accent (`) inserts an additional small space and the tilde (~) inserts an additional large space into formulas. However, in the basic installation of LibreOffice, they are ignored when they occur at the end of a formula. If you are employing text in a formula, it may be necessary to include spacing at the end of formulas as well. This customization is only required when working with a Math document and is not required when inserting a formula into another LibreOffice component.

To add spacing at the end of formula in Math, go to **Tools > Options > LibreOffice Math > Settings** on the Menu bar and uncheck **Ignore ~ and ` at the end of the line** in the *Miscellaneous Options* section.



Note

To customize LibreOffice Math settings, open LibreOffice Math and then navigate to **Tools > Options > LibreOffice Math > Settings**.

Scaling of code in the Formula Editor input window

By default, the code in the Formula Editor input window (Figure 306) is scaled to 100%. However, the LibreOffice Math section in the Options dialog can only be accessed from within the Math component. It is not available when editing a formula in a document in any other LibreOffice component. The scaling factor can be changed by going to **Tools > Options > LibreOffice Math > Settings** on the Menu bar and changing the percent in the **Scaling code input window** box in the *Miscellaneous Options* section. For example, if the scaling is changed to 150%, the code in the input window will appear larger. This setting affects the Formula Editor in all LibreOffice components.

Extensions

For frequent formula creation and editing, you can customize LibreOffice by adding extensions that are designed to help create formulas. Extensions are easily installed using the Extension Manager. For more information on how to install extensions, see Chapter 13, Customizing LibreOffice.

A commonly used extension is **Formatting of All Math Formulas**. It allows all Math formulas to be formatted in a Writer, Calc, Draw, or Impress document. With it the font names and font sizes of all formulas can be changed in a document. For more information on this extension, go to <https://extensions.libreoffice.org/en/extensions/show/formatting-of-all-math-formulas>.

Exporting and Importing

MathML format

In addition to exporting documents as PDFs, LibreOffice offers the possibility of saving formulas in the MathML format. This allows the insertion of formulas into documents that were created in other software, for example, Microsoft Office or an internet browser.



Note

If internet browsers do not fully support the MathML format, they may not display the formulas correctly.

If working on a Math document, go to **File > Save as** on the Menu bar or use the keyboard combination *Ctrl+Shift+S* to open the Save as dialog. Select MathML in the list of available file formats in *File type* to save the formula as MathML.

If you are working in another LibreOffice component, right-click on the formula object and select **Save Copy as** in the context menu to open the Save as dialog. Select MathML in the list of available file formats in *File type* to save the formula object as MathML.

MathML formulas can be imported into Math by using **Tools > Import MathML from Clipboard** on the Menu bar.

Microsoft file formats

To control how formulas in Microsoft format are imported and exported using LibreOffice, go to **Tools > Options > Load/Save > Microsoft Office** on the Menu bar and select or deselect the options for *MathType to LibreOffice Math* or *reverse*.

- [L]: Load and convert the object
- [S]: Convert and save the object

[L]: Load and convert the object

When a Microsoft document must be opened in LibreOffice, this option allows you to convert Microsoft OLE objects into the specified LibreOffice OLE objects. For formulas, any embedded MathType objects must not exceed the MathType 3.1 specifications to be successfully loaded and converted. Information on MathType format can be found at https://docs.wiris.com/en/mathtype/office_tools/microsoft_office.

If a document containing OMML formulas has been saved in .docx format and then converted to the older .doc format, then any OMML objects are converted into graphics, which will be displayed in LibreOffice as graphics.

[S]: Convert and save the object

If LibreOffice OLE objects need to be converted and saved in Microsoft file format, select this option, which will allow LibreOffice to convert any formulas into a format that can be read and modified by Microsoft Equation Editor and MathType.

When this option is not selected, the formula is treated as an OLE object on conversion into a .doc format and remains linked to LibreOffice. A double-click on the object in Microsoft Office will attempt to launch LibreOffice.



LibreOffice
Community



Chapter 10

Working with File Formats, Security, and Exporting

File formats

LibreOffice can open a wide variety of file formats as shown below in addition to the Open Document Format (ODF), including Portable Document Format (PDF).

Most file formats are automatically detected by LibreOffice and can be opened without explicitly selecting the document format in the file picker.

Text documents

Writer can read Open Document text formats (.odt, .ott, .oth, .odm, and .fodt), and the following text formats (including various legacy formats):

- Microsoft Word 6.0/95/97/2000/XP/Mac (.doc and .dot)
- Microsoft Word 2003 XML (.xml)
- Microsoft Word 2007/2010 XML (.docx, .docm, .dotx, .dotm)
- Microsoft WinWord 5 (.doc)
- Microsoft Works (.wps)
- Abiword Document (.abw, .zabw)
- MacWrite Document (.mw, .mcw)
- Text CSV (.csv and .txt)
- DocBook (.xml)
- T602 Document (.602, .txt)
- Apple Pages (.pages)
- HTML Document (.htm, .html)
- WordPerfect Document (.wpd)
- Lotus WordPro (.lwp)
- ClarisWorks/Appleworks Document (.cwk)
- Rich Text Format (.rtf)
- StarWriter formats (.sdw, .sgl, .vor)
- Unified Office Format text (.uot, .uof)
- Hangul WP 97 (.hwp)
- eBook (.pdb)
- OpenOffice.org 1.x (.sxw, .stw, and .sxc)

When opening .htm or .html files used for web pages, LibreOffice customizes Writer for working with these files.

Spreadsheets

Calc can open Open Document spreadsheet formats (.ods, .ots, and .fods) as well as the following spreadsheet formats (including various legacy formats):

- Microsoft Excel 97/2000/XP (.xls, .xlw, and .xlt)
- Microsoft Excel 4.x–5.0/95 (.xls, .xlw, and .xlt)
- Microsoft Excel 97-2003 (.xml)
- Microsoft Excel 2007-365 (.xlsx, .xlsm, .xltx, .xltm)
- Microsoft Excel 2007-2010 binary (.xlsb)
- Lotus 1-2-3 (.wk1, .wks, and .123)
- Data Interchange Format (.dif)
- Rich Text Format (.rtf)
- Text CSV (.csv and .txt)
- StarCalc (.sdc and .vor)
- OpenOffice.org 1.x (.sxc and .stc)
- dBASE (.dbf)
- SYLK (.slk)
- Unified Office Format spreadsheet (.uos, .uof)
- HTML Document (.htm and .html files, including Web page queries)
- Quattro Pro 6.0 (.wb2)
- Apple Numbers 2 (.numbers)

Presentations

Impress can open the various Open Document presentation formats (.odp, .odg, .otp, and .fopd) as well as the following presentation formats:

- Microsoft PowerPoint 97/2000/XP (.ppt and .pot)
- Microsoft PowerPoint 2007-365 (.pptx, .pptm, .potx, .potm)
- StarDraw and StarImpress (.sda, .sdd, .sdp, and .vor)
- OpenOffice.org 1.x (.sxi and .sti)
- Unified Office Format presentation (.uop, .uof)
- CGM – Computer Graphics Metafile (.cgm)
- Portable Document Format (.pdf)
- Apple Keynote 5 (.key)

Graphics

Draw can use the Open Document graphic file formats (.odg and .otg) and PDF files as well as the following graphic formats:

- Adobe Photoshop (*.psd)
- AutoCAD Interchange Format (*.dxf)
- Corel Draw (*.cdr)
- Corel Presentation Exchange (*.cmx)
- Microsoft Publisher 98-2010 (*.pub)
- Microsoft Visio 2000-2013 (*.vdx; *.vsd; *.vsdm; *.vsdx)
- WordPerfect Graphics (*.wpg)
- OpenOffice.org 1.x (.sxd and .std)
- Bitmap (*.bmp)
- Joint Photographic Experts Group (*.jpeg, *.jpg)
- Picture Exchange (*.pcx)
- Sun Raster (*.ras)
- Truevision TGA (*.tga, *.icb, *.vda, *.vst)
- Drawing Exchange Format, or Drawing Interchange Format (*.dxf)
- eMule Resource Files (*.met)
- Portable Gray Map (*.pgm)
- Open Office, or Star Office Draw (*.sda)
- Tag Image File Format (*.tif, *.tiff)
- Windows Metafile (*.wmf)
- Enhanced Windows Metafile (*.emf)
- Portable Bitmap Image (*.pbm)
- Portable Network Graphics (*.png)
- StarOffice Presentation (*.sdd)
- Encapsulated Postscript (*.eps)
- Kodak Photo CD (*.pcd)
- Portable Pixmap (*.ppm)
- Scalable Vector Graphics (*.svg)
- X Window System or X BitMap (*.xbm)
- Graphics Interchange Format (*.gif)
- Macintosh Picture Image (*.pct)
- Photoshop Document (*.psd)
- StarView Metafile (*.svm)
- X Windows System (*.xpm)

Formulas

Math can use Open Document Formula files (.odf) as well as the formats used by OpenOffice.org 1.x (.sxm), StarMath (.smf), and MathML (.mml) files.

When opening a Word document that contains an embedded equation editor object, if the option **MathType to LibreOffice Math or reverse** is checked in **Tools > Options > Load/Save > Microsoft Office** (macOS **LibreOffice > Preferences > Load/Save > Microsoft Office**), the object is automatically converted to a LibreOffice Math object.

File formats for saving

If you save a LibreOffice file in an ODF format, that file will be correctly rendered if it is transferred to another user; reopened in a later version of LibreOffice; or opened with another application that can open ODF files. Thus, we strongly recommend that you save files in an ODF as file format. However, files can be saved in other formats, if required.



Tip

If the document needs to be shared and it is not going to be modified, the preferred option is to convert the document to PDF. LibreOffice has an easy method to convert documents to PDF.

Text documents

In addition to the ODF text formats (.odt, .ott, and .fodt), Writer can save files in the following formats:

- Office Open XML Text (.docx)
- Microsoft Word 2007–365 (.docx, .dotx)
- Microsoft Word 97–2003 (.doc)
- Microsoft Word 2003 XML (.xml)
- Rich Text Format (.rtf)
- Text (.txt)
- Text Encoded (.txt)
- Unified Office Format text (.uot, .uof)
- HTML Document (.html and .htm)
- DocBook (.xml)



Notes

Since LibreOffice provides encryption support within the Microsoft Word filter, password protected Microsoft Word documents can be saved.

While the .rtf format is often used to transfer text files between applications, there is a loss of formatting and images. Thus, users should employ other formats.

Spreadsheets

Calc can save in the ODF spreadsheet formats (.ods, .ots, and .fods) as well as the following formats:

- Office Open XML Spreadsheet (.xlsx)
- Data Interchange Format (.dif)
- Microsoft Excel 2007–365 XML (.xlsx)
- dBase (.dbf)
- Microsoft Excel 97–2003 (.xls and .xlw)
- SYLK (.slk)
- Microsoft Excel 97–2003 Template (.xlt)
- Text CSV (.csv and .txt)
- Microsoft Excel 2003 XML (.xml)
- Unified Office Format spreadsheet (.uos)
- HTML Document (Calc) (.html and .htm)

Presentations

Impress can save in the ODF presentation formats (.odp, .otp, .fodp, and .odg), as well as the following formats. Impress can also export to Draw-compatible graphic formats.

- Microsoft PowerPoint 2007–365 (.pptx, .potm)
- Microsoft PowerPoint 2007–365 AutoPlay (.ppsx)
- Microsoft PowerPoint 97–2003 (.ppt)
- Microsoft PowerPoint 97–2003 Template (.pot)
- Microsoft PowerPoint 97–2003 AutoPlay (.pps)
- Office Open XML Presentation (.pptx, .potm, .ppsx)
- Unified Office Format presentation (.uop)

Drawings

Draw can save in the ODF Drawing formats (.odg, .otg, and .fodg) and it can also export to the graphics formats:

- APNG – Animated Portable Network Graphic
- BMP – Windows Bitmap
- EMF – Enhanced Metafile
- EMZ – Compressed Enhanced Metafile
- EPS – Encapsulated PostScript
- GIF – Graphic Interchange Format
- JPEG – Joint Photographic Expert Group
- PNG – Portable Network Graphic
- SVG – Scalable Vector Graphics
- SVGZ – Compressed Scalable Vector Graphics
- TIFF – Tagged Image File Format
- WEBP – WebP Image
- WMF – Windows Metafile
- WMF - Compressed Windows Metafile

Writer/Web documents

Writer/Web can save to the following formats:

- HTML document (.html and .htm), as HTML 4.0 Transitional
- Text and Text Encoded (LibreOffice Writer/Web) (.txt)

Exporting files

LibreOffice uses the term “export” for file operations where there is a change of file type. Unlike Save As, exporting the file produces a document while keeping the current file format of the actual document. If the file type cannot be found in **File > Save As** on the Menu bar, check **File > Export** on the Menu bar (not available in Math) for additional file types.

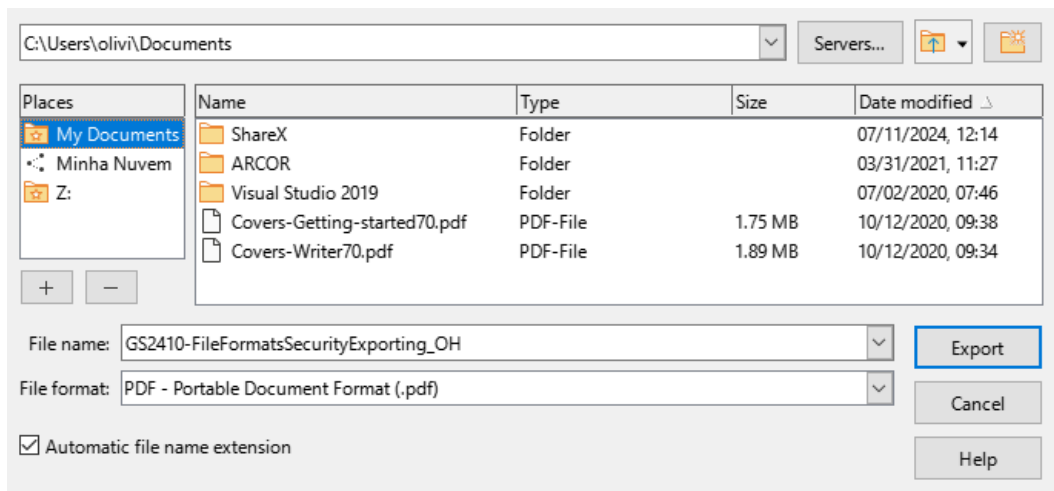

Figure 318: Export dialog

If the PDF file format is needed, LibreOffice can export Writer, Calc, Impress, and Draw, documents in that format. Writer can also export in EPUB. Also, LibreOffice can export files in HTML and XHTML formats. Draw and Impress can also export in several image and graphic formats.

Note

If you use the Export command, LibreOffice will create a copy of the file as a new file using the selected format. The original file will remain open in LibreOffice.

PDF quick export

If a file needs to be quickly exported to the PDF format, LibreOffice is unable to select various file options such as file format, page range, and image compression. For a quick PDF export, do the following:

- 1) Open the target file in LibreOffice.
- 2) Open the Export dialog (Figure 318) and use one of the following methods:
 - Click on **Export Directly as PDF** on the Standard toolbar.
 - Go to **File > Export As > Export Directly as PDF** on the Menu bar.
- 3) Enter a file name and select the required location for the PDF file in the Export dialog.
- 4) Click on **Export** to create the PDF file and close the Export dialog.

Note

By default, a file in PDF format is not protected against contents tampering, or editing. Contents of a PDF file can be edited by specialized software tools, including LibreOffice Draw.

Controlled PDF export

If you need more control over the content and quality of a file that will be exported in the PDF format, do the following in the PDF Options dialog (Figure 319):

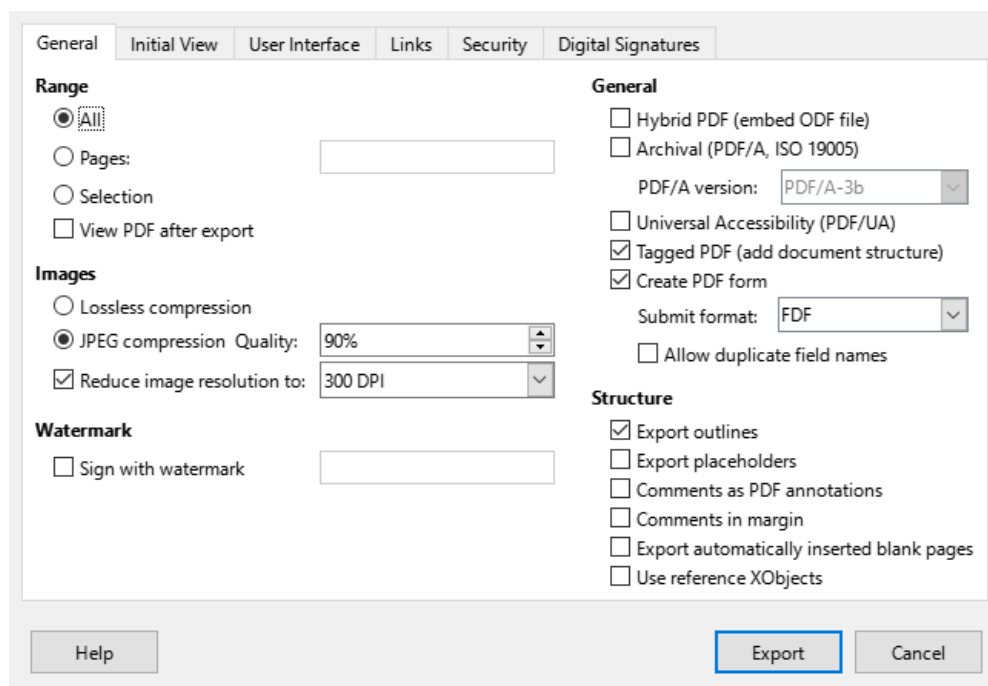

Figure 319: PDF Options dialog — General page

- 1) Open the target file in LibreOffice.
- 2) Access PDF Options by going to **File > Export As > Export as PDF**.
- 3) Select the various options required on each tabbed page of the PDF Options dialog.
- 4) Click on **Export** to open the Export dialog.
- 5) Navigate to the required folder for the PDF file.
- 6) Enter a file name the PDF file and click on **Export** to save the PDF file in its selected location.

General PDF options

Refer to Figure 319 to see the PDF options available on the **General** page of the PDF dialog.

Range

Sets the export options for the pages included in a PDF file.

All

Exports all defined print ranges. If no print range is defined, the entire document will be exported.

Pages

Exports the pages that you have selected. To export a range of pages, use the format 3-6. To export single pages, use the format 7;9;11. If you want, you can export a combination of page ranges and single pages, by using a format like 3-6;8;10;12.

Selection

Exports all the current selection.

View PDF after export

Opens the exported PDF file in the default PDF viewer application.

Images

Sets the PDF export options for images in a PDF file.

Lossless compression

Selects lossless compression for the image. All pixels are preserved. This setting can create large files when used with photographs.

JPEG compression quality

Determine the JPEG compression's quality level. Almost all pixels are preserved if you choose a high quality level, but if you use a low quality level, file sizes are reduced but some pixels are lost and artifacts are introduced.

Reduce image resolution

Lower DPI (dots per inch) images have lower quality. Lower resolutions (100 DPI or less) may be sufficient for viewing on a computer screen, but many modern devices have much higher resolutions. For printing it is generally preferable to use at least 300 or 600 DPI, depending on the capability of the printer. Higher DPI settings increase the size of the exported file.



Note

Encapsulated PostScript (EPS) images with embedded previews are exported only as previews. EPS images without embedded previews are exported as empty placeholders.

Watermark

Add a centered, vertical, light green watermark text to the page background. The watermark is not part of the source document.

Sign with watermark

Insert the required text for the watermark signature. When this option is selected, a watermark signature appears on the PDF pages.

General

Sets general PDF export options.

Hybrid PDF (embed ODF file)

Use this setting to export the document with a hybrid file format: PDF and ODF. In PDF viewers it behaves like a normal PDF file, but remains fully editable in LibreOffice.

Archive (PDF/A, ISO 19005)

Converts to the PDF/A-1b, PDF/A-2b, or PDF/A-3b format. All fonts used in the source document are embedded in the generated PDF file, and PDF tags are created. The primary purpose is to create an electronic document whose appearance is independent of device and application, making it suitable for long term preservation.

PDF/A-2b is recommended for most users, because it allows for layers and transparency with shapes and images. It also compresses better (JPEG 2000) than PDF/A-1b, usually producing smaller files. PDF/A-3b is identical to PDF/A-2b, but also accepts embedding of other file formats.

Universal Accessibility (PDF/UA)

Creates a universal, accessible PDF file that follows the requirements of PDF/UA (ISO 14289) specifications.

Tagged PDF (add document structure)

Tagged PDFs contain information about the structure of document contents. This can help to display the document on devices with different screens and using screen

reader applications. Some tags that are exported are table of contents, hyperlinks, and controls. This option can increase file sizes significantly.

Create PDF form

If you are submitting forms within the PDF file, select the available options from the *Submit format* drop-down list. This menu will override the URL property that is set in the document. Only one setting is valid for the PDF document: PDF (sends the whole document); FDF (sends the control contents); HTML, and XML. Normally PDF format is selected.

Allow duplicate field names

Allows the use of the same field name for multiple fields in a generated PDF file. If disabled, field names are assigned generated unique names.

Structure

Sets options for diverse features such as bookmarks, comments, page layout, and so on.

Export outlines

Use this option to export bookmarks of Writer documents as PDF bookmarks. Bookmarks are created for all outline paragraphs and for all table of contents entries where hyperlinks are assigned in the source document.

Only paragraphs with Outline level 1 — 10 are exported. The name of the Paragraph Style is irrelevant. For example, the default version of Paragraph Style Title is not exported when its Outline level is Text Body.

Export placeholders

This option is only available in Writer. The user can choose if the PDF file will include any defined placeholder fields, which can be filled in by users.

Comments as PDF annotations

If this option is selected, comments are included in the PDF file as annotations.

To export comments of Writer documents as displayed in LibreOffice, select **Tools > Options > LibreOffice Writer > Print** (macOS **LibreOffice > Preferences > LibreOffice Writer > Print**) and select the *In margins* option in **Comments**. The exported pages are scaled down and the comments are placed into margins.

Export automatically inserted blank pages

If selected, blank pages are automatically inserted in the PDF file. This is recommended if you are printing the PDF file as a double-sided document. For example, books usually have chapters set to start on an odd-numbered (right-hand) page. When the previous chapter ends on an odd page, LibreOffice inserts a blank page between the two odd pages. This option controls whether to export that blank page.

Use reference XObjects

This option determines how PDF images will be exported back into a PDF file.

When this option is disabled, the first page of the PDF data is included in the output. The PDF export merges images, fonts and other resources during export. This is a complex operation, but the result can be viewed in various viewers.

If this option is enabled, the reference XObject markup is used. This is a simple operation, but PDF viewers must support this to use vector images. Otherwise, a fallback bitmap is shown in the viewer.

More information can be found in the *PDF specification, ISO 32000-2:2017* (<https://www.iso.org/standard/63534.html>).

Initial View PDF options

The **Initial View** page in the PDF Options dialog (Figure 320) allows users to determine how the PDF file opens by default in a PDF viewer.

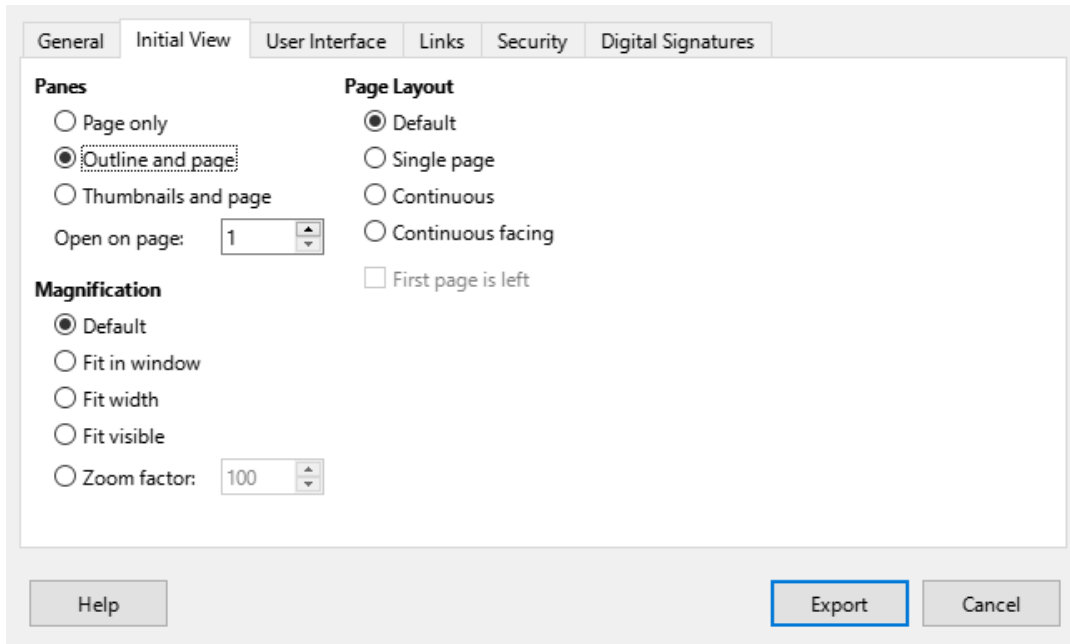

Figure 320: PDF Options dialog — Initial View page

Panels

Page only

Generate a PDF file that shows only page contents.

Outline and page

Generate a PDF file that shows a bookmarks palette and page contents.

Thumbnails and page

Generate a PDF file that shows a thumbnails palette and the page contents.

Open on page

Enter a page number to display that page when a PDF reader opens a PDF file.

Magnification

Default

Generate a PDF file that shows the page contents without zooming. If the PDF reader application is configured to use a zoom factor by default, the page displays with that zoom factor.

Fit in window

Generate a PDF file that displays the page zoomed to fit entirely into a PDF reader window.

Fit width

Generate a PDF file that displays the page zoomed to fit the width of a PDF reader window.

Fit visible

Generate a PDF file that displays the text and graphics on the page zoomed to fit the width of a PDF reader window.

Zoom factor

Enter a zoom factor which determines when a PDF reader opens a PDF file.

Page layout

Default

Generate a PDF file that displays the pages according to the layout setting of the PDF reader application.

Single page

Generate a PDF file that displays one page at a time.

Continuous

Generate a PDF file that displays pages in a continuous vertical column.

Continuous facing

Generate a PDF file that displays pages side by side in a continuous column. For more than two pages, the first page is displayed on the right.

First page is left

Generate a PDF file that shows pages side by side in a continuous column. For more than two pages, the first page is displayed on the left. **Complex Text Layout** must be enabled in **Tools > Options > Language Settings > Languages** (macOS **LibreOffice > Preferences Language Settings > Languages**) for this option to be available.

User Interface PDF options

The **User Interface** page in the PDF Options dialog (Figure 321), allows users to specify how the interface for an external PDF viewer will appear. If you need to create a PDF file that will be used as a presentation or a kiosk-type display, these options are useful.

Window Options

Resize window to initial page

Generate a PDF file that is shown in a window displaying the whole initial page.

Center window on screen

Generate a PDF file that is shown in a PDF reader application that is centered on the display.

Open in full screen mode

Generate a PDF file that is shown in full screen in a PDF reader window and in front of all other windows.

Display document title

Generate a PDF file that will display the file title in the PDF reader's title bar.

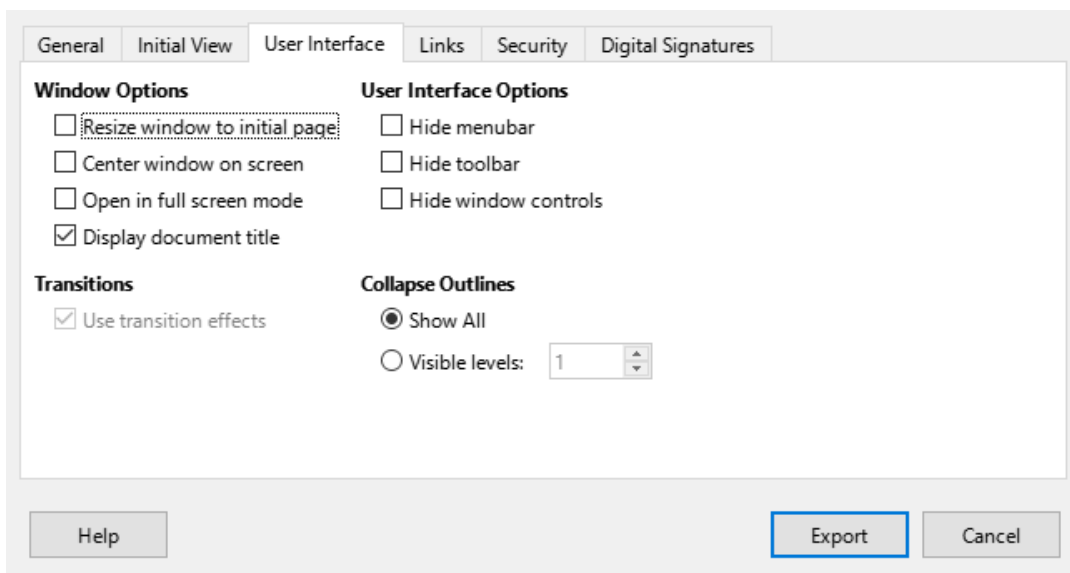

Figure 321: PDF Options dialog — User Interface page

User Interface Options

Hide menubar

Hide the menu bar when a PDF file is active.

Hide toolbar

Hides the toolbar when a PDF file is active.

Hide window controls

Hides the reader controls when a PDF file is active.

Transitions

Use transition effects

Exports Impress slide transition effects to respective PDF effects.

Collapse Outlines

Show All

Select to show all outline levels as bookmarks when a PDF reader opens a PDF file.

Visible levels

Select to show bookmarks down to the selected level when a PDF reader opens a PDF file.

Links PDF options

The PDF Options dialog **Links** page (Figure 322) specifies how outlines and hyperlinks will be exported in a document.

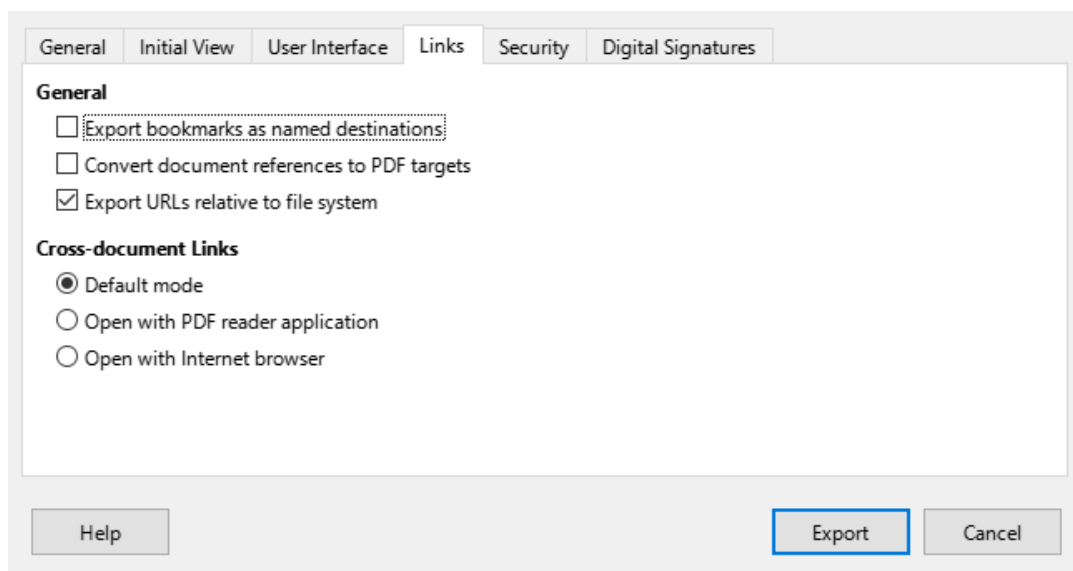

Figure 322: PDF Options dialog — Links page

General

Export outlines as named destinations

The bookmarks (targets of references) in PDF files are defined as rectangular areas. Additionally, bookmarks to named objects are defined by their names. A checkbox can allow you to export the names of objects in a document as valid bookmark targets. This allows objects to be exported by name from other documents.

Convert document references to PDF targets

This option automatically converts filename extensions in URLs from ODF to PDF. In the referencing URLs, the extensions `.odt`, `.odp`, `.ods`, `.odg`, and `.odm` are converted to the extension `.pdf`.

Export URLs relative to file system

This option allows URLs to be exported to other documents as relative URLs in the file system.

Cross-document links

Specify how to handle hyperlinks from a PDF file to other files.

Default mode

All links from a PDF document to other documents are handled as specified in the computer operating system.

Open with PDF reader application

Cross-document links are opened with the PDF reader application that currently shows the document. The PDF reader application must be able to handle the specified file type inside the hyperlink.

Open with Internet browser

Cross-document links are opened with a web browser. The web browser must be able to handle the specified file type inside the hyperlink.

Security PDF options

The **Security** page in the PDF Options dialog (Figure 323) specifies the security options used by an exported PDF file.

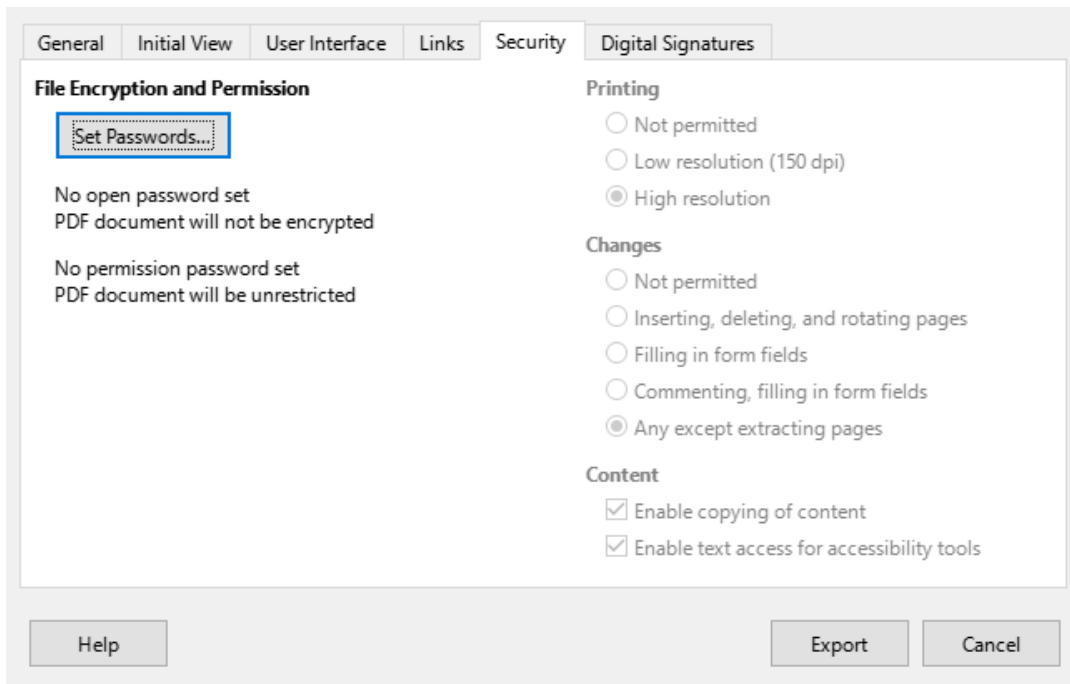

Figure 323: PDF Options dialog — Security page

Note

The document permission restrictions set by a password are observed only by PDF readers compliant with the version 1.5 of the PDF format. For older PDF readers, these restrictions may have no effect.

File Encryption and Permission

Set passwords

Opens a dialog box where passwords are entered. Specify a password required for viewing a PDF file. Enter an optional password that allows a user viewing the PDF to edit and/or print the document.

Printing

Not permitted

Users will not be able to print the document.

Low resolution (150 dpi)

The document can only be printed in low resolution (150 dpi). However, some PDF readers ignore this option.

High resolution

The document can be printed in high resolution.

Changes

Not permitted

The content of the PDF file cannot be changed.

Inserting, deleting, and rotating pages

Inserting, deleting, and rotating pages will be permitted.

Filling in form fields

Filling in form fields is permitted.

Commenting, filling in form fields

Only commenting and filling in form fields is permitted.

Any except extracting pages

All changes are permitted, except extracting pages.

Contents

Enable copying of content

Content can be copied to the clipboard.

Enable text access for accessibility tools

Select to enable text access for accessibility tools.

Digital Signature PDF options

The PDF Options dialog's **Digital Signatures** page in Figure 324 specifies how the exported PDF file can be digitally signed.

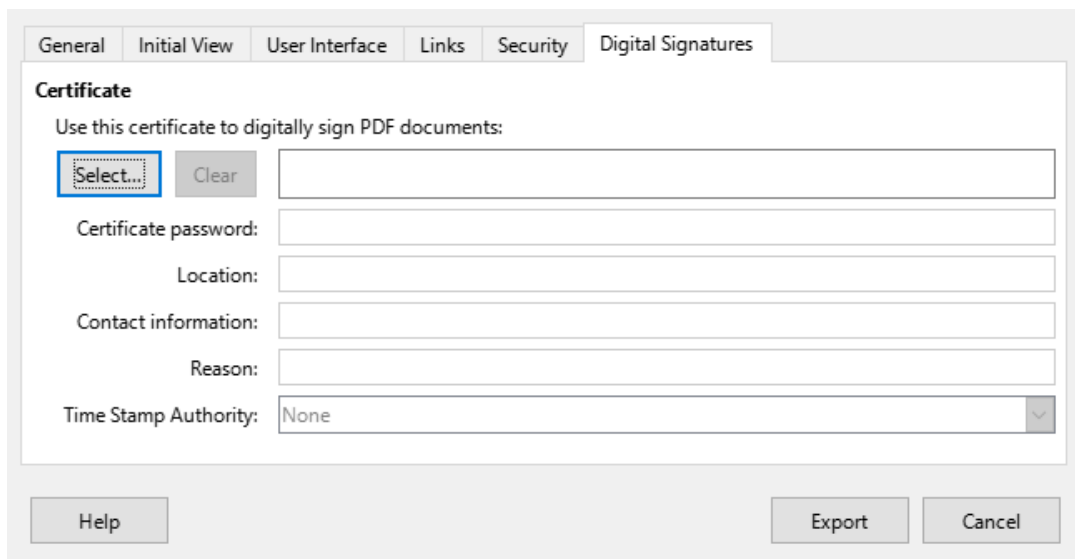

Figure 324: PDF Options dialog — Digital Signatures page

- Digital signatures are used to ensure that the PDF was really created by the original author and that the document has not been modified since it was signed.
- The signed PDF export uses the keys and X.509 certificates already stored in a default key store location, or on a smart card.
- When using a smart card, it must already be configured for use by a key store. This is usually done during installation of smart card software.

Certificate

Use this certificate to digitally sign PDF documents

Allows users to select a certificate to be used for signing a PDF export.

Select

Opens the Select Certificate dialog.

All certificates found in the selected key store are displayed. If the key store is protected by a password, there is a prompt to enter a password. When using a smart card that is protected by a PIN, there is a prompt to enter the PIN.

Select the certificate to use for digitally signing the exported PDF by clicking on the corresponding line, then click **OK**.

All other fields on the Digital Signatures page are only accessible after a certificate has been selected.

Certificate password

Enter the password that will be used to protecting the private key associated with the selected certificate. Usually this is the key store password.

Notes

If the key store password has already been entered in the Select Certificate dialog box, the key store may already be unlocked and not require the password again. But to be on the safe side, enter the password.

When using a smart card, enter the PIN here. Some smart card software prompts you to enter the PIN again before signing.

Location, Contact information, Reason

These three fields allow additional information to be entered about the digital signature that is applied to the PDF (where, by whom and why it was made). It is embedded in the appropriate PDF fields and is visible to anyone viewing the PDF. Each, or all of the three fields, are optional and may be left blank.

Time Stamp Authority

The PDF signing process uses the Time Stamp Authority (TSA) to obtain a digitally signed timestamp that is then embedded in the signature. This (RFC 3161) timestamp allows viewing of the PDF to verify when the document was signed.

If no TSA URL is selected (the default), the signature is timestamped, but it uses the current time from the local computer.

EPUB format export (Writer only)

EPUB is standard for electronic book files with the extension `.epub` that can be downloaded and read on devices like smartphones, tablets, computers or e-readers. The EPUB format is implemented as an archive file consisting of HTML files carrying the content, along with images and other supporting files.

Writer can export a file to EPUB. A text-only document generally exports well, but some contents (such as illustrations, tables, and cross-references) may not export correctly.

Quick EPUB export

If you choose to quickly export a Writer file to the EPUB file format, there is no control over content and quality of the EPUB file.

- 1) Open the Writer file that is going to be converted.
- 2) Go to **File > Export As > Export Directly as EPUB** on the Menu bar and the Export dialog opens.
- 3) Navigate to the folder where the EPUB file is going to be saved.
- 4) Enter a file name in the *File name* text box. The format of the exported file is fixed to EPUB Document (`.epub`).
- 5) Click on **Export** and the Writer file is converted to an EPUB file and saved in the selected location.

Controlled EPUB export

To control the content and quality of the resulting EPUB file in Writer, do the following:

- 1) Open the Writer file that is going to be converted.
- 2) Go to **File > Export As > Export as EPUB** and open the EPUB Export dialog (Figure 325).
- 3) Enter the necessary information into the various options in EPUB Export dialog. For more information, refer to “EPUB export options” below.
- 4) Click OK to close the EPUB Export dialog and open the Export dialog.
- 5) Navigate to the folder where the EPUB file is going to be saved.
- 6) Enter a file name in the *File name* text box. The format of the exported file is fixed to EPUB Document (.epub).
- 7) Click on **Export** and the Writer file is converted to an EPUB file and saved in the selected location.

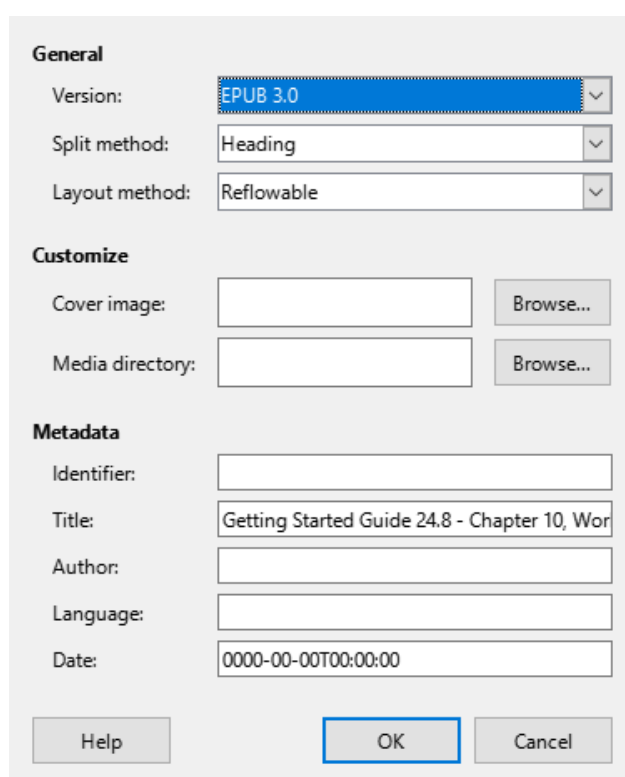

Figure 325: EPUB Export dialog

Tip

Other ways to export to EPUB from Writer (.odt) files include Calibre, an open source e-book manager that runs on Windows, macOS, and Linux. Calibre provides many e-book conversion facilities (including PDF to EPUB) and allows editing of the conversion. See <https://calibre-ebook.com/> for more information.

EPUB export options

General

Version

Sets the version of the resulting EPUB file.

Split method

Select the type of start of the next EPUB section.

Heading — Starts the next section on headings, according to the document outline numbering.

Page break — Starts the new section on a page break.

Layout method

Determines the layout that is generated for the EPUB document.

Reflowable — Content flows (or reflows) to fit the screen and to fit the needs of the user. This also means that page style information (for example, page size or header/footer content) will not be exported.

Fixed — Gives greater control over presentation when a reflowable EPUB is not suitable for its content.

Customize

Custom cover image

Enter the full path of the custom cover image file. If the entry is empty, the exporter uses the cover image in the media directory when the name is one of the following: `cover.gif`, `cover.jpg`, `cover.png`, or `cover.svg`. The custom cover image is embedded in the EPUB file.

Custom media directory

Enter the custom media directory for the EPUB file. The media directory may contain a cover image as seen above, custom metadata and image links.

By default, the exporter looks inside a folder in the current document directory with the same name of the document file name for custom media and custom metadata. For example, if the document name is `MyText.odt`, the default media folder for cover and metadata is `MyText` in the current directory.

For custom metadata, provide a file with same name as the original filename with the extension `.xmp`. The provided metadata overrides the internal document metadata. In the example above, the custom metadata must exist in the `MyText` directory as `MyText.xmp`.

Image links mean that if create relative links are created on images or text and they link an image that is available in the media directory, then this media is available in the EPUB export file as a pop-up.

Metadata

Enter the custom metadata that overrides the document default metadata. These text fields can be left empty.

Identifier

Enter a unique identifier for the publication.

Title

Enter the title of the publication.

Author

Enter the Author of the publication.

Language

Language of the publication (see RFC4646 and ISO 639 for possible values).

Date

Last modification date for the publication. The value of this property must be an XML Schema date Time conformant date in the form: `CCYY-MM-DDThh:mm:ssZ`. Default is the date and time when the export dialogue box opened.

Creating HTML files

The easiest way to create HTML documents in LibreOffice is to start with an existing text document. For example, in Writer, go to **View > Web** and the view will change to show how the text document appears as a web page. However, **Web** view does not show which features will, or will not be saved correctly in HTML format. Refer to “HTML files using Writer/Web” below for more information on creating a web page from a text document.

Text documents

Note

The use of styles in the text document is strongly recommended when saving, or exporting to HTML, or XHTML format.

Saving a text document as HTML is limited by the HTML 4.0 Transitional specification. Text documents in office suites normally use a richer set of resources that do not appear in HTML, for example page formatting. Do not expect the same layout when saving a file in HTML format.

Saving as HTML

A text document can be saved in HTML format so that it can be viewed in a web browser. To generate a separate HTML page, you can associate a page break with a specific heading paragraph style each time that style appears in the document. The Writer module automatically creates a page containing hyperlinks to each of these pages.

When you save a text document in HTML format, any graphics in the document are saved into the HTML document as embedded data streams. For graphics, JPEG, or SVG formats are saved as HTML and all other graphic formats are saved as PNG.

LibreOffice generates the image files and the HTML file necessary to create an HTML page in a browser. The number of files generated by the format conversion depends on the number of images and objects in the original text document. Refer to Table 15 for the file types created and file content when saving HTML format.

Table 15: File types created saving in HTML format

File	Contents
Myfile.html	The text contents, page layout, text attributes, meta tags, and styles.
Myfile_html_[random number].gif	GIF images of visible contents of OLE objects.
Myfile_html_[random number].png, jpg, or bmp	Images inserted in the text document as PNG, BMP, or JPEG keep their original format.

To create a HTML file from a text document, do the following:

- 1) Create a new folder which will be a location for the HTML file and images.
- 2) To open the Save As dialog, select **File > Save As** on the Menu bar.
- 3) Navigate to the required location in the Save As dialog.
- 4) Enter a file name for the HTML file in the *File name:* text box.
- 5) In *File type:*, select **HTML Document (Writer) (.html)** as the file type.
- 6) Click on **Save** to save the file as HTML and close the Save As dialog.
- 7) If necessary, click on **Use HTML Document (Writer) Format** in the Confirmation dialog that opens confirming the file is saved as HTML.

Export as XHTML

If you want LibreOffice to export a text document as a XHTML file, LibreOffice generates an XHTML file for each text document. Image files are also embedded in the XHTML file. LibreOffice-generated XHTML files have better layout rendering, but fail to render objects other than images.

- 1) If necessary, create a new folder as a location for the HTML file and images.
- 2) Go to **File > Export** on the Menu bar to open the Export dialog (Figure 318 on page 422).
- 3) Navigate to the location of the new folder in the Export dialog.
- 4) Enter a file name for the HTML file in the *File name:* text box.
- 5) In *File type:*, select **XHTML (Extensible Hypertext Markup Language)** as the file type.
- 6) Click on **Export** to save the file as XHTML and close the Export dialog.

Notes

Writer does not replace multiple spaces in the original document with the HTML code for non-breaking spaces. To create extra spaces in a HTML file or web page, insert non-breaking spaces in LibreOffice. To enter non-breaking spaces, use the keyboard shortcut *Ctrl+Spacebar* (macOS +*Shift+Spacebar*).

The Tab character is not rendered when LibreOffice exports to XHTML. Instead, use borderless tables to position contents instead of the Tab character in a line. You will have to change the bullet and number lists that insert a Tab character between the bullet or number and the text—instead, create a list style where the Tab character is replaced by a space.

Objects that are different from usual image formats are not rendered in LibreOffice XHTML output. This includes drawings, spreadsheets, charts, and OLE objects in general. To render an OLE object in XHTML, replace the document's OLE object with an image of the OLE object.

Saving document as a series of web pages

Writer can save a large document as a series of web pages (HTML files) with a table of contents page. To this, follow these steps:

- 1) Decide which heading style in a document starts a new page and make sure all those headings have the same paragraph style, for example, Heading 1.
- 2) Go to **File > Send > Create HTML Document** on the Menu bar and open the Name and Path of the HTML Document dialog (Figure 326).
- 3) Navigate to the place where the HTML file is going to be saved.
- 4) Enter a file name in the *File name:* text box.
- 5) Select **HTML Document** from options available from the *File type:*.
- 6) In *separated by:*, select the style from the drop-down list that is going to create a new page in the HTML file, for example Heading 1.
- 7) Click on **Save** to create the multi-page HTML document and close the dialog. The HTML files created conform to the HTML 4.0 Transitional standard.

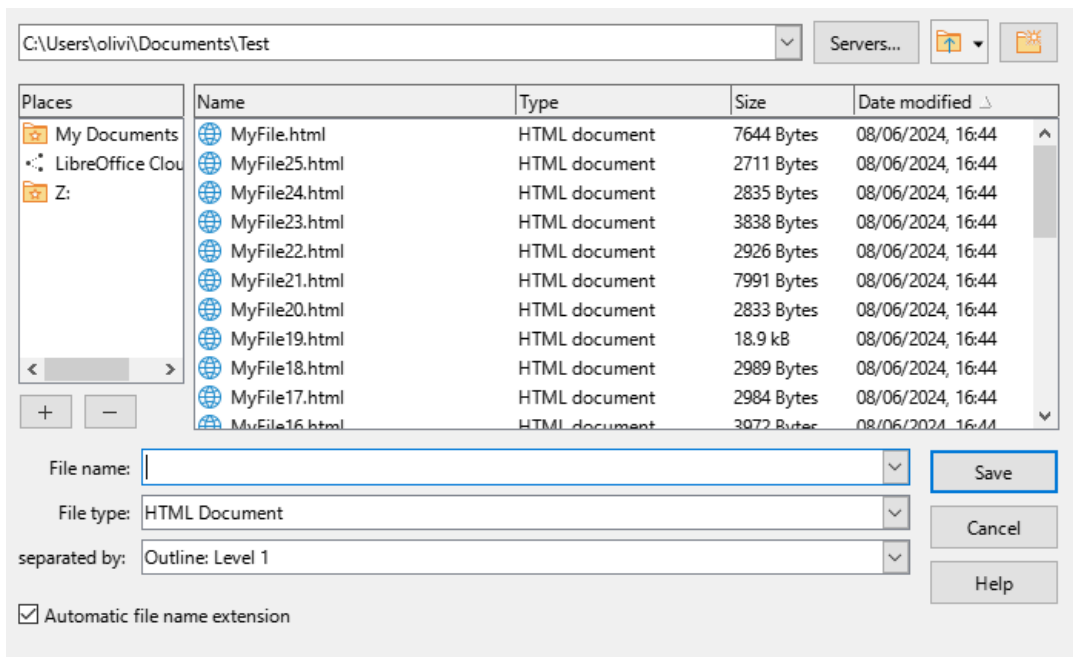

Figure 326: Name and Path of the HTML Document dialog

Spreadsheets

Calc can save spreadsheet files as HTML documents. If the file contains more than one sheet, the additional sheets follow each other in the HTML file. Links to each sheet are placed at the top of the HTML document. To do this task, perform the following steps:

- 1) If necessary, create a new folder as a location for the HTML file.
- 2) Open the Save As dialog by selecting **File > Save As** on the Menu bar.
- 3) Navigate to the required location in the Save As dialog.
- 4) Enter a file name for the HTML file in the *File name:* text box.
- 5) Select **HTML Document (Calc) (.html)** in the *File type: field*.
- 6) Click on **Save** to save the file as HTML and close the Save As dialog.
- 7) If necessary, click on **Use HTML Document (Calc) Format** in the Confirmation dialog that opens confirming the file is saved as HTML.

Note

Calc allows the insertion of links directly into a spreadsheet using the Hyperlink dialog. See Chapter 4, Working with Styles, Templates and Hyperlinks, for more information on hyperlinks.

Presentations and drawings

Exporting

Impress presentations and Draw drawings cannot properly be saved in HTML format, but can be exported as SVG documents with the Export command. To export a presentation or a drawing:

- 1) Select the slides or pages to export.
- 2) Open the Export dialog by selecting **File > Export**.
- 3) Navigate to the required location in the Export dialog.

4) Select **SVG – Scalable Vector Graphics (.svg)** in the File format list box.

5) Click on **Export** to export to SVG format and close the dialog.

The export SVG file contains the selected exported slides or drawing pages.

TIP

Most modern browsers can open and render SVG files. On a multi slide or page export, use the mouse wheel, mouse buttons, left and right arrows, *Page Up* and *Page Down* keys to scroll the slides or pages. You can use the browser zoom keyboard and mouse combination to enlarge or shrink the exported images. Most modern browsers also have a full-screen mode suitable to display the exported page as in a slide show.

Note

The SVG export preserves slide transition and object animation.

HTML files using Writer/Web

LibreOffice Writer has a configuration called Writer/Web that can create, edit, and save files in HTML format. Writer/Web is only available when working with documents that are in HTML format.

Display modes

By default, Writer/Web opens an HTML file in **Normal** view (Figure 327). To change Writer/Web to **Web** view, go to **View > Web** on the Menu bar (Figure 328). If necessary, **Normal** or **Web** view are used to add to an HTML document, then edit and format the contents of the HTML document. The contents in an HTML document are rendered as if displayed in a browser.

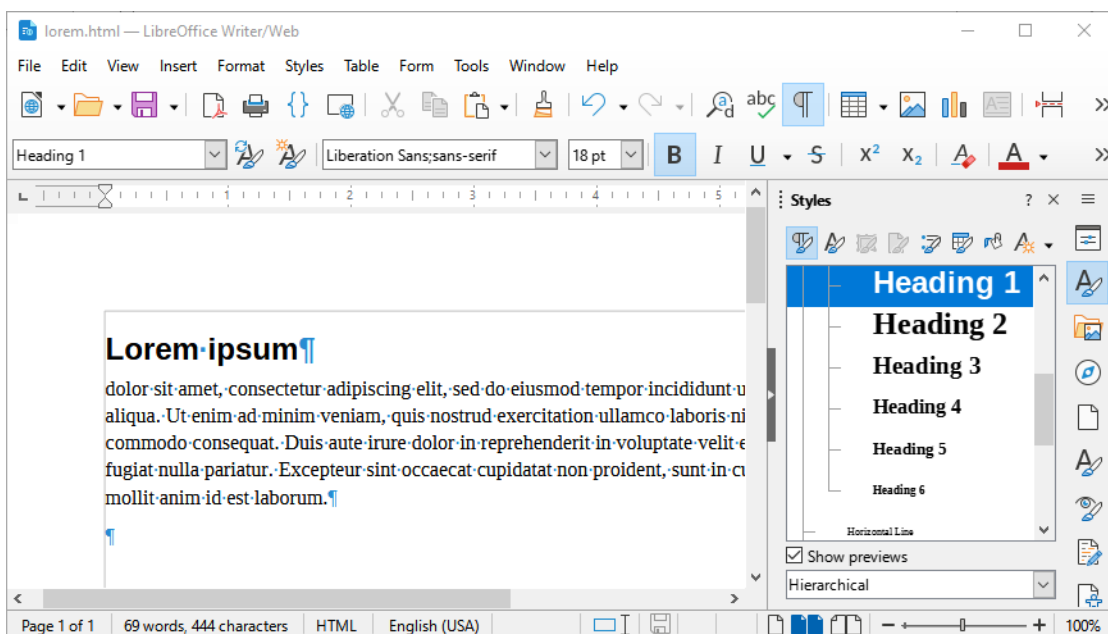

Figure 327: Example of Normal view in Writer/Web

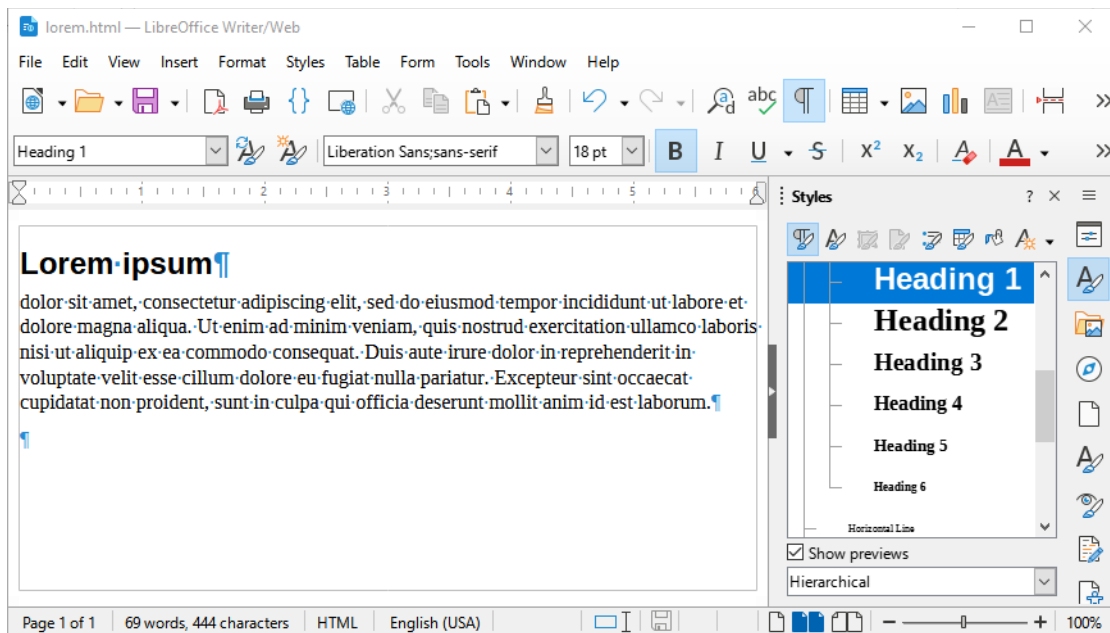

Figure 328: Example of Web view in Writer/Web

Writer/Web can also display the source code of an HTML document. Go to **View > HTML Source** on the Menu bar to open the source code display for an HTML document (Figure 329). The **HTML Source** display mode is used to change the formatting and page elements of a web page. Using this display mode for editing requires familiarity and knowledge of the HTML markup language.

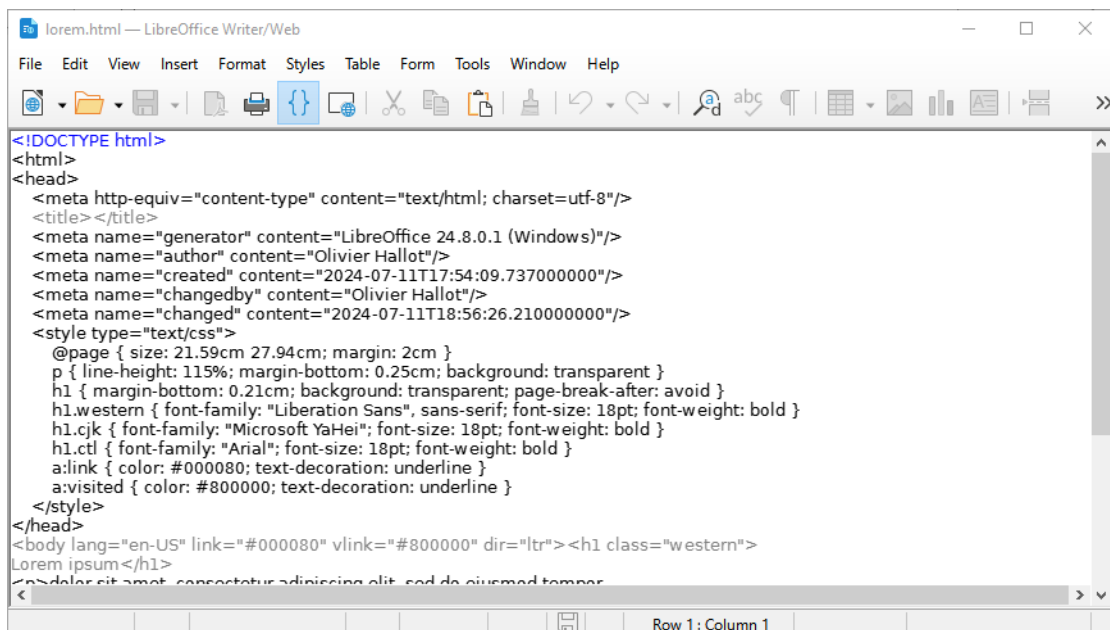

Figure 329: Example of HTML Source view in Writer/Web

Notes

HTML markup language has fewer formatting options than a ODF text document. Writer/Web does not provide all formatting features for HTML documents and some formatting dialogs have fewer options available. For example, a HTML paragraph has no tab settings.

HTML markup content generated by Writer/Web is limited to the elements used to produce a displayable document in a web browser. It does not contain other components of a website such as external cascading style sheets (CSS), external JavaScript, or other script languages. When you manually insert links to any external components into the web page, you must do it in **HTML Source** display mode.

Creating and editing

To create an HTML document, do the following:

- 1) Select **File > New > HTML Document** and Writer/Web opens a blank document in Web display mode (Figure 328).
- 2) Add content to the document by typing or pasting text, images, tables, and other objects.
- 3) Use all the formatting resources available in Writer/Web, including the capability to edit and format the content in styles.
- 4) When all editing is complete, go to **File > Save As** on the Menu bar and save the document in the HTML file type.
- 5) Preview the HTML document in a browser to make sure it has rendered correctly.

Editing source code

To edit the source code of an HTML document:

- 1) Open or create an HTML document.
- 2) Open HTML source view (Figure 329) using one of the following methods:
 - Go to **View > HTML Source** on the Menu bar.
 - Click on **HTML source** on the Standard toolbar.
- 3) Add, or edit the HTML source code.
- 4) When all editing is complete, go to **File > Save As** on the Menu bar and save the document as HTML file type.
- 5) Preview the HTML document in a browser to make sure it renders correctly.

Previewing HTML documents

It is important to preview HTML documents in a web browser to make sure it displays correctly. Since not all browsers render HTML files the same way, you should preview an HTML document in several browsers.

To make LibreOffice open the default web browser and display an HTML document, use one of the following methods:

- Go to **File > Preview in Web Browser** on the Menu bar.
- Click **Preview in Web Browser** on the Standard toolbar.
- Open the web browser and then open the HTML file in the browser.

Writer/Web options

Go to **Tools > Options > LibreOffice Writer/Web** (macOS **LibreOffice > Preferences > LibreOffice Writer/Web**) on the Menu bar to open the Options LibreOffice Writer/Web dialog (Figure 330), and then you can define the basic settings for LibreOffice documents in HTML format. For more information on the options available for Writer/Web, go to the LibreOffice Help website.

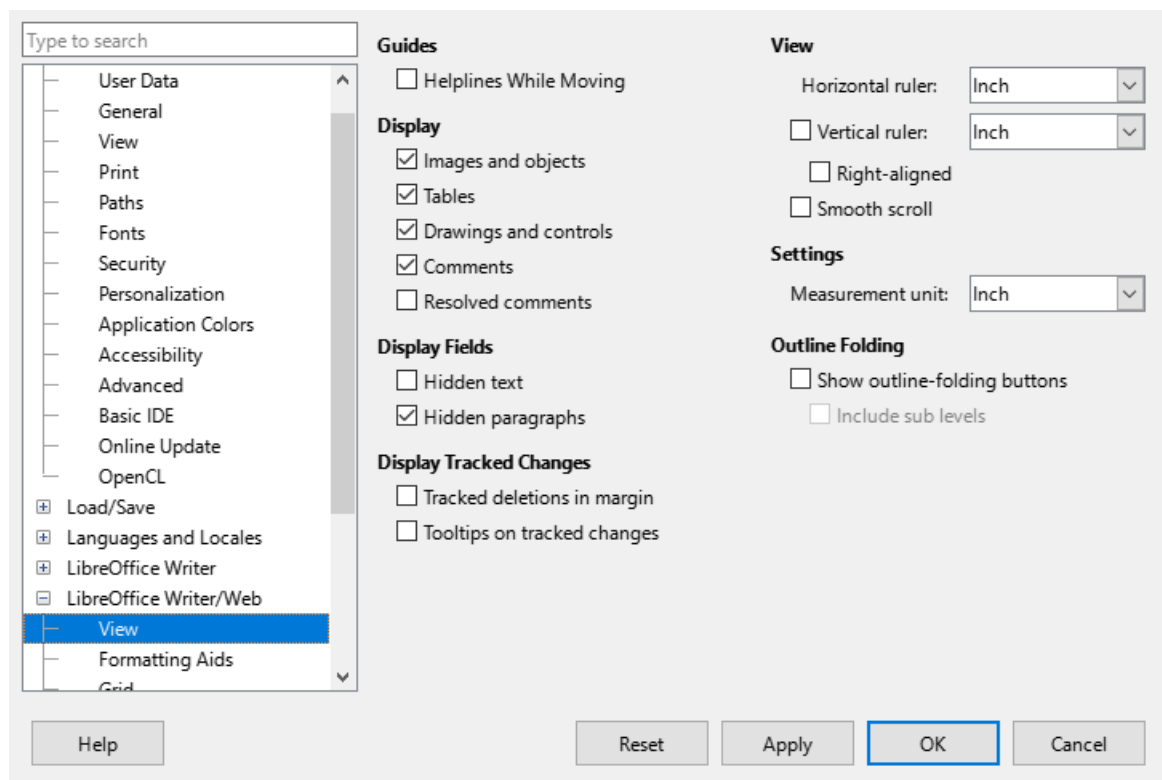

Figure 330: Options LibreOffice Writer/Web dialog

Click on a tab in the dialog to access the available options. The tabbed pages are as follows:

View

Defines the default settings for displaying objects in text documents and also the default settings for the window elements.

Formatting Aids

Defines the LibreOffice text and HTML documents' display for certain characters and for the direct cursor.

Grid

Specifies the settings for the configurable grid for document pages. This grid helps to determine the exact position of objects. Also, this grid can be set to align with the snap grid in LibreOffice.

Print

Specifies print settings within a text or HTML document.

Table

Defines the attributes of tables in text documents.

Background

Specifies the background for HTML documents. The background is valid for creating new HTML documents and for HTML documents already created. Any created HTML documents must not have a background defined to use this option.

Emailing documents

LibreOffice has multiple ways to send documents as email attachments in one of three formats — Open Document Format (LibreOffice default format); Microsoft Office format; Portable Document Format.

- 1) Go to **File > Send** on the Menu bar and use one of the following options:
 - **Email Document** — The default email program is opened and the document is attached to the email message.
 - **Email as OpenDocument text** — The default email program is opened and the document is attached to the email message.
 - **Email as Microsoft Word** — LibreOffice creates a file in Microsoft Word format, opens the default email program, and the document is attached to the email message.
 - **Email as PDF** — First, the PDF Options dialog opens. Next, select the required settings required and click OK. LibreOffice will open the default email program with the PDF file attached to the email message.
- 2) Enter the recipient name, subject, and message, then send the email.

Note

The above procedure is for sending text documents as an attachment to an email. When sending spreadsheets, presentations, or drawings, the email options change to reflect the type of document being attached to an email message.

Files on remote servers

LibreOffice can open and save files stored on remote servers. Keeping files on remote servers allows access to documents using different computers. For example, working on a document in the office during the day and edit the same document at home for last-minute changes. Storing files on a remote server also backs up documents from computer loss or hard disk failure. Some remote servers can also check-in and check-out files controlling usage and access for documents.

LibreOffice supports many document servers that use well known network protocols such as FTP, WebDav, Windows share, and SSH. It also supports popular services like Google Drive and Microsoft OneNote, as well as commercial and open source servers that implement the OASIS CMIS standard.

Access a remote server connection as follows. The following procedure is an example only. Actual procedure depends on operating system, computer setup and type of remote file service selected.

- 1) Open the Remote Files dialog (Figure 331) using one of the following methods:
 - Click on **Remote Files** in the LibreOffice Start Center.
 - Select **File > Open Remote** on the Menu bar.
 - Select **File > Save Remote** on the Menu bar.
- 2) Click on **Manage Services**, and select **Add service** to open the File Services dialog (Figure 332).

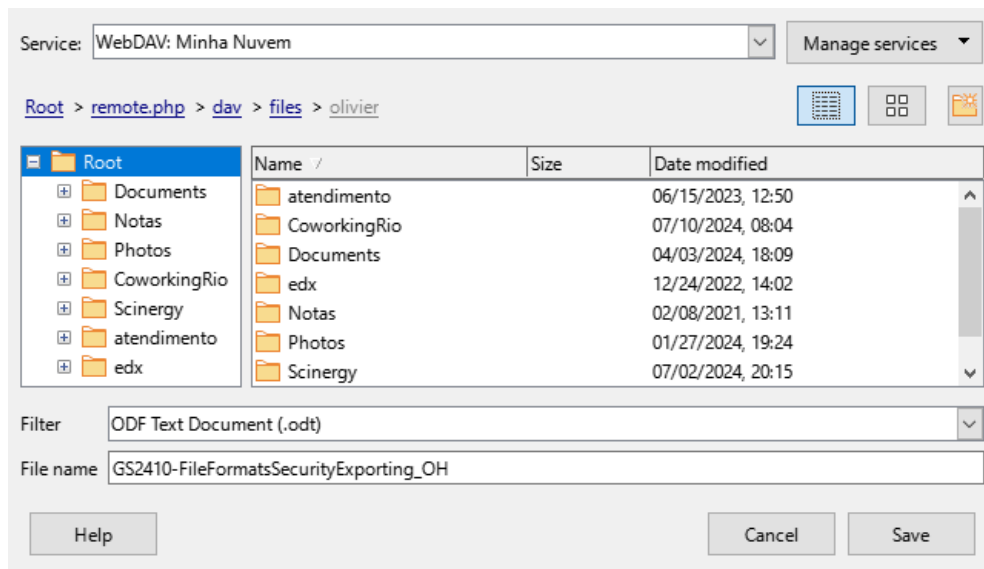

Figure 331: Remote Files dialog

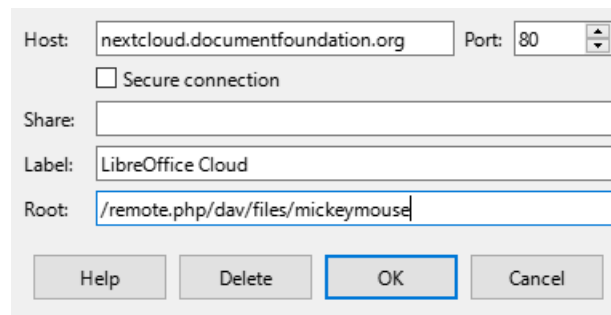

Figure 332: File Services dialog

- 3) Select the type of file service required from options available in the **Type** drop-down list. Depending on the file service selected, different parameters are necessary for connection to a remote server.
- 4) Enter the necessary information in the text boxes. The text boxes change depending on the type of service that has been selected in **Type**.
- 5) If necessary, enter a label for the remote server in the **Label** text box.
- 6) Click on **OK** to save the details and close the File Services dialog.
- 7) In the Remote Files dialog, select the service from the Service drop-down list.
- 8) Navigate to where the remote file is located and select the required file.
- 9) Click on **Open** to open the file and close the Remote Files dialog.

Digital signatures

To sign a file digitally, a personal key, also known as a certificate, is required. This personal key is stored on the computer being used as a combination of a private key, which must be kept secret, and a public key. These keys are added to a drawing when a digital signature is applied. A certificate is obtained from a certification authority, which may be a private company or a government institution.

When a digital signature is applied to a document, a checksum is computed from the document content, plus the personal key being used. The checksum and public key are stored together with the document.

When the document is opened on another computer with a recent version of LibreOffice, the program computes the checksum again and compares it with the stored checksum. If both checksums are the same, the program opens the original, unchanged document.

In addition, the program can display the public key information from the certificate. This information can then be compared with the public key that is published on the web site of the certificate authority. Whenever a document is changed, this change breaks the digital signature.

For more information on digital signatures, see “About Digital Signatures” and “Applying Digital Signatures” on the LibreOffice Help website.

Applying digital signatures

This is a sample method for digitally signing a document in LibreOffice. Your actual procedure depends on how your computer is set up and what operating system is being used.

- 1) Go to **File > Digital Signatures > Digital Signatures** on the Menu bar and open the Digital Signatures dialog (Figure 333) that lists the available digital signatures for the document.

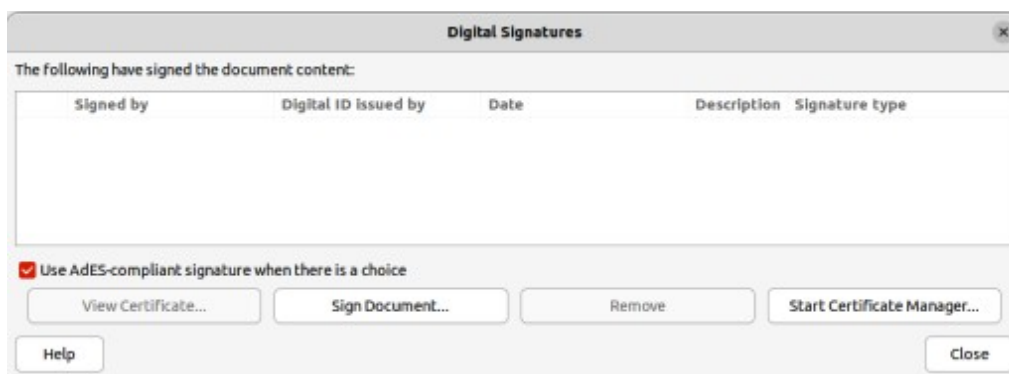

Figure 333: Digital Signatures dialog

- 2) If a message box opens advising to save the document, click on **Yes** to save the document.
- 3) If necessary, click on **Sign Document** to open the Select Certificate dialog (Figure 334).

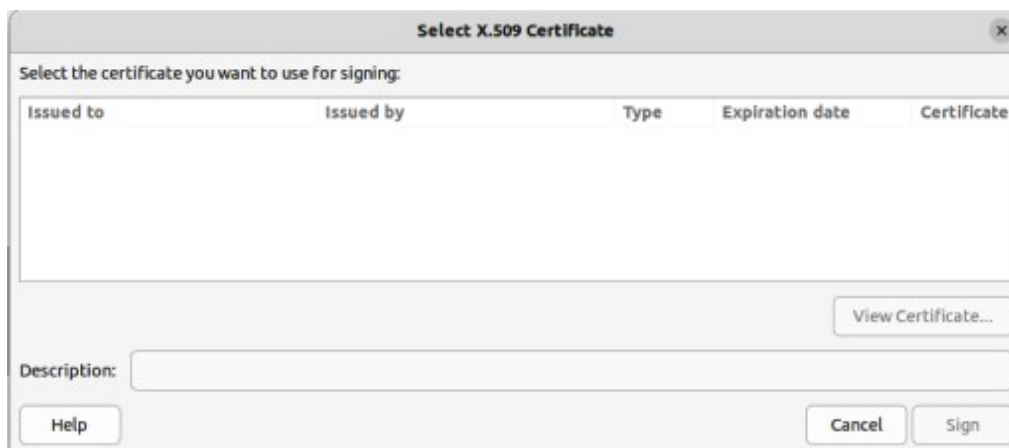

Figure 334: Select Certificate dialog

- 4) Select the required digital signature in the Select Certificate dialog.
- 5) Click on **Sign** to apply the digital signature to the document and close the Select Certificate dialog.

- 6) In the Digital Signatures dialog, select the required digital signature from the signature list.
- 7) Click on **Close** to apply the selected digital signature to the document and close the Digital Signatures dialog.
- 8) Go to **File > Save** on the Menu bar to save the document.

Notes

A signed document displays a **Digital Signature** icon in the Status Bar. Double-click on this **Digital Signature** icon to view the certificate. More than one digital signature can be added to a document.

Changing an existing description invalidates a digital signature. However, multiple digital signatures from the same author are allowed, because each digital signature can have a different description.

Signature line

Graphic boxes, that includes a signature line, can also be added to a document. This allows the user to optionally sign a document with their signature. This option is only available for Writer and Calc documents.

Add a graphic signature box to a Writer, or Calc document as follows:

- 1) Go to **Insert > Signature Line** on the Menu bar to open the Signature Line dialog (Figure 335).
- 2) Enter the necessary details and select the required options.
- 3) Click **OK** to close the Signature Line dialog and a graphic box with a signature line is inserted into the document. An example is shown in Figure 336.

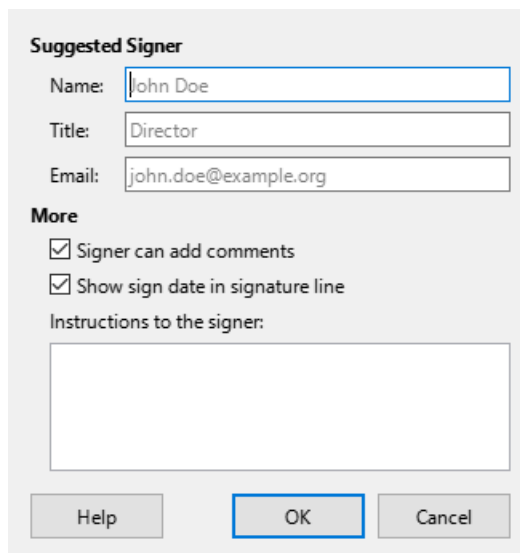

Figure 335: Signature Line dialog

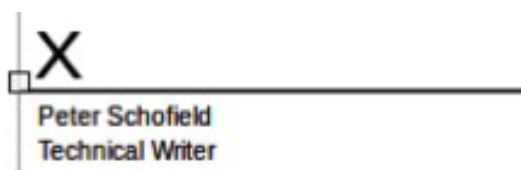

Figure 336: Example of a signature box

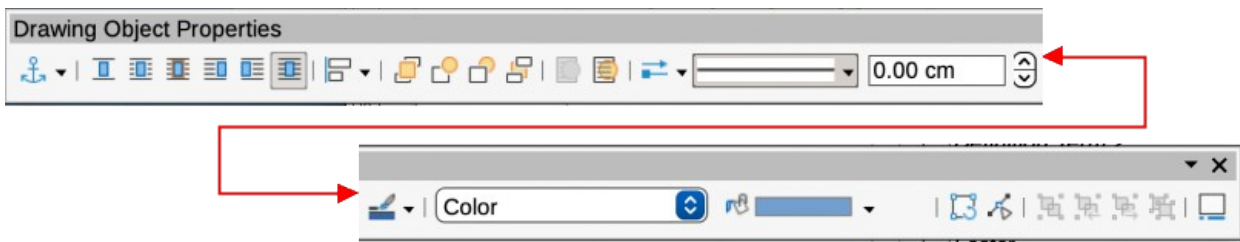

Figure 337: Drawing Object Properties dialog

- 4) Click on the signature box to select it and display the object selection handles.
- 5) Use the keyboard arrow keys to move the signature box to the required position on the page. The normal position for a signature box is at the bottom of a page.
- 6) Right click on the selected signature box to open the Drawing Object Properties toolbar (Figure 337).
- 7) Click on **Select anchor for object** and select the required anchor type from the options available in the drop-down list.
- 8) If necessary, use the other tools available on the Drawing Object Properties toolbar to format the signature box to the document requirements.
- 9) Deselect the signature box to close the Drawing Object Properties toolbar.
- 10) Save the document and fix the signature box into the document.

Document properties

To open a document's Properties dialog (Figure 338), go to **File > Properties** on the Menu bar. The tabbed pages in the Properties dialog provides information about the document and allows the document's properties to be changed.

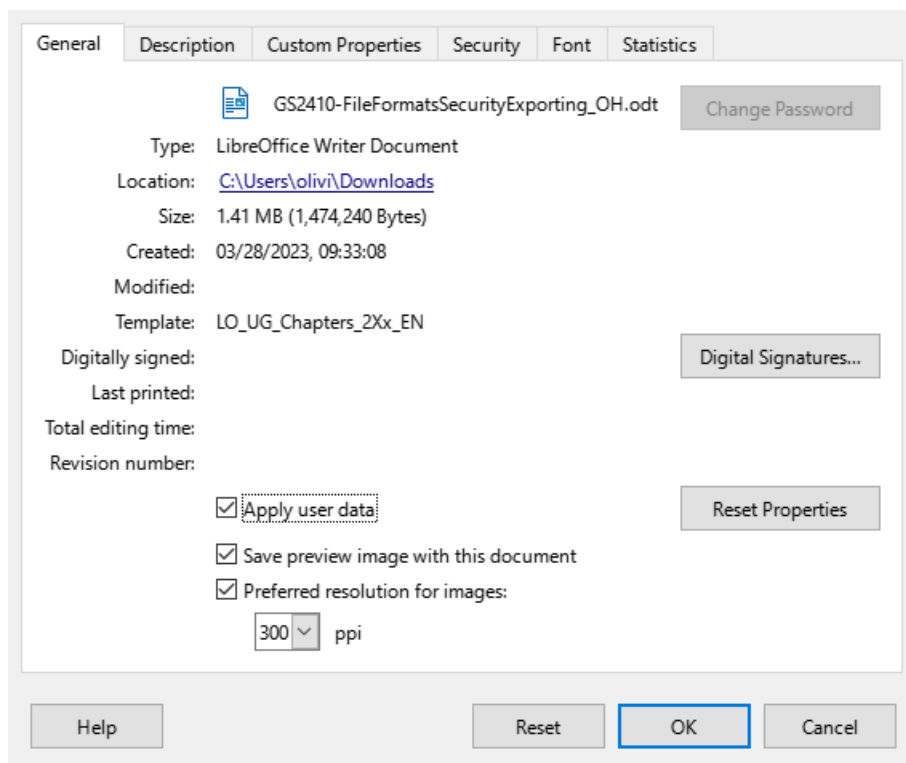

Figure 338: Properties dialog

General

Contains basic information about the current file as follows:

File

Displays the file name.

Change Password

Opens a dialog to change the password if a password has been set for the file.

Type

Displays the file type for the current document.

Location

Displays the path and the name of the directory where the file is stored.

Size

Displays the size of the current document in bytes.

Created

Displays the date, time and author when the file was first saved

Modified

Displays the date, time and author when the file was last saved in a LibreOffice file format.

Template

Displays the template that was used to create the file.

Digitally signed

Displays the date and the time when the file was last signed as well as the name of the author who signed the document.

Digital Signatures

Opens the Digital Signatures dialog box where digital signatures are managed for the current document.

Last printed

Displays the date, time and user name when the file was last printed.



Note

After printing, a document must be saved to preserve the **Last printed** data. No warning message is displayed if an unsaved document is closed.

Total editing time

Displays the amount of time that the file has been open for editing since the file was created. The editing time is updated when the file is saved.

Revision number

Displays the number of times that the file has been saved.

Apply user data

Saves the full name of the user with the file. The user data can be changed by going to **Tools > Options > LibreOffice > User Data** (macOS **LibreOffice > Preferences > LibreOffice > User Data**) on the Menu bar.

Reset Properties

Resets the editing time to zero, the creation date to the current date and time, and the version number to 1. The modification and printing dates are also deleted.

Save preview image with this document

Saves a thumbnail preview in PNG format inside the document. This image may be used by a file manager under certain conditions.

Preferred resolution for images

Select this option and enter a value in Points Per Inch (ppi) for the preferred image resolution. This is used as default when an image is inserted into a Writer, Impress, or Draw document and resize images according to the value in the list box.

Reset

Resets any changes made to the document and is available for all tabbed pages in the Properties dialog.

Description

Contains optional editable descriptive information about the document, which may be exported as metadata to other file formats.

Title

Enter a title for the document.

Subject

Enter a subject for the document. A subject can be used to group documents with similar contents.

Keywords

Enter the words that required to index the content of the document. Keywords must be separated by commas. A keyword can contain white space characters, or semicolons.

Contributor, Coverage, Identifier, Publisher, Relation, Rights, Source, Type

These are the Dublin Core Metadata Element Set for describing resources.

Comments

Enter comments to help identify the document.



Tip

Title, Subject and Keywords are exported to PDF files as PDF Document Properties. Entered values are exported and appear in the corresponding fields in the PDF Document Properties Description.

Custom Properties

Allows custom information fields to be added to a document. In a new document, this page may be blank. If the new document is based on a template, this page may contain custom properties (Figure 339).

Properties

Enter the *Name*, *Type* and *Value* for each custom property required. The custom properties are exported as metadata to other file formats.

Add

Click to add a new row to the custom property list.

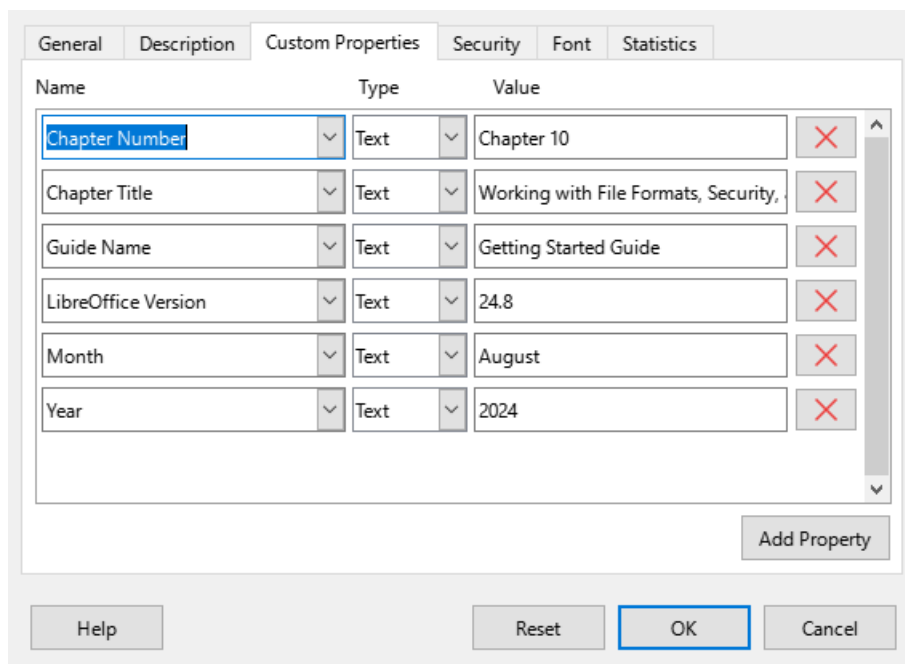

Figure 339: Custom Properties page

Security

Sets the password options for the current document.

Open file read-only

Select to allow this document to be opened in read-only mode only.

Note

This file sharing option protects the document against accidental changes. It is still possible to edit a copy of the document and save that copy with the same name as the original.

Record changes

Select to enable recording changes. This is the same as **Edit > Track Changes > Record** on the Menu bar.

Tip

To protect the recording state with a password, select **Protect** and enter a password. Other users of this document can apply changes, but cannot disable change recording without knowing the password.

Protect/Unprotect

Protects the change recording state with a password. If change recording is protected for the current document, the button is named **Unprotect**. Click **Unprotect** and type the correct password to disable the protection.

Font

When Embed fonts in the document is selected, any fonts used in the document will be embedded into the document. This may be useful if you are creating a PDF and want to control how it will look on other computer systems.

Only embed the fonts that are used in your documents. If fonts have been defined for the document (for example, in the template), but have not been used, select this option to not embed them. You can choose which types of fonts are embedded: Latin, Asian, Complex.

Font Embedding

Select this option to embed document fonts into the document file and allow portability between different computer systems. The document with embedded fonts has a larger size and the fonts are used on the target computer for better rendering of the document layout.

Consider embedding fonts when a document use rare, or custom fonts not generally available in other computers.



Note

Font licenses may restrict embedding fonts in documents. Font files contain flags that indicate if and how they can be embedded within a document file. LibreOffice parses these flags and determines if and how it may be embedded in a document file. When opening a document containing embedded fonts, LibreOffice looks at these flags to determine if and how a document can be viewed or edited.

Font scripts to embed

Select which types of fonts are embedded: Latin, Asian, Complex.

Statistics

Displays statistics for the current file, for example number of pages, words, and characters.

Document classification

Document classification and security is an important issue for businesses and governments. LibreOffice has implemented the open standards produced by TSCP (Transglobal Secure Collaboration Participation, Inc.) containing three BAF (Business Authentication Framework) categories: Intellectual Property, National Security and Export Control with each category having four BAILS (Business Authorization Identification and Labeling Scheme) levels: Non-Business, General Business, Confidential, and Internal Only.

While this standard has been developed with the intent that it would be applicable in any domain of activity, LibreOffice retained the aerospace and defense industry nomenclature and categories, where sensitivity marking results from national security, export control and intellectual property policies.

To enable document classification, go to **View > Toolbars > TSCP Classification** on the Menu bar to open the TSCP toolbar. This toolbar contains list boxes helping in selection of security for a document. LibreOffice then adds custom fields in the document properties (**File > Properties, Custom Properties** on the Menu bar) to store the classification policy as document metadata.

To prevent a breach in security policy, contents with a higher classification level cannot be pasted into documents with a lower classification level.

Business Authentication Framework (BAF) Categories

The default BAF categories for LibreOffice are listed below.

Intellectual Property

Select this category for general purpose document classification.



Tip

The **Intellectual Properties** category modifies the layout of a document with a watermark, fields in the header and footer and an information bar on top of the document area. Each item inserted in the document is controlled by the classification configuration file.

National Security

Selecting this category assigns the national security policy type to the document. The selected category is saved together with the document as BAILS metadata in the file properties and no modifications are carried in the document layout or the user interface.

Export Control

Selects this category assigns the export control policy type to the document. The selected category is saved together with the document as BAILS metadata in the file properties and no modifications are carried in the document layout or the user interface.



Note

Refer to the corporate data security policy and information security officers for support in document classification.

Default levels of classification

LibreOffice provides default levels of document classification (BAILS) shown below, sorted by increasing level of business sensitivity:

Non-Business

Information in document has no impact in business, if made public.

General Business

Minor impact. Information has impact in business, can generate embarrassments, minor damage in brand image, if made public.

Confidential

Modest impact. Information disclosed can damage business brand, can generate negative media coverage and loss of revenue.

Internal use only

Major damage. Negative national media, lawsuits, fines, long term brand damages.

Customizing classification levels

LibreOffice allows users to customize the levels of classification for a business. To customize the number and the name of the levels, copy a file, for example `example.xml`, located in **Tools > Options > LibreOffice > Paths > Classification** (macOS **LibreOffice > Preferences > LibreOffice > Paths > Classification**) into a local folder and edit the contents. Save the file and make the required changes to the classification path to access the file.

Pasting contents

Pasting contents in documents with different levels of classification prevents a breach in the security policy, contents with high classification level pasted to documents with lower classification level are not allowed. LibreOffice displays a warning message wherever it detects that the contents of the clipboard have higher security classification than the target document.

User and personal data

Removing data

If you need to remove personal data, versions, notes, hidden information, or recorded changes are removed from a file before sending it to other users, take the following steps:

- 1) Go to **Tools > Options > LibreOffice > Security** (macOS **LibreOffice > Preferences > LibreOffice > Security**) on the Menu bar to open the **Security** page of the Options LibreOffice dialog.
- 2) Click **Options** to open the Security Warnings dialog (Figure 340).
- 3) Select the required options to display warnings and/or set security options. See “Security Warnings” on page 453 for more information.
- 4) Click **OK** to close the Security Options and Warnings dialog.
- 5) Go to **File > Properties** on the Menu bar to open the Properties dialog (Figure 338) and click on **General** to open the **General** page.

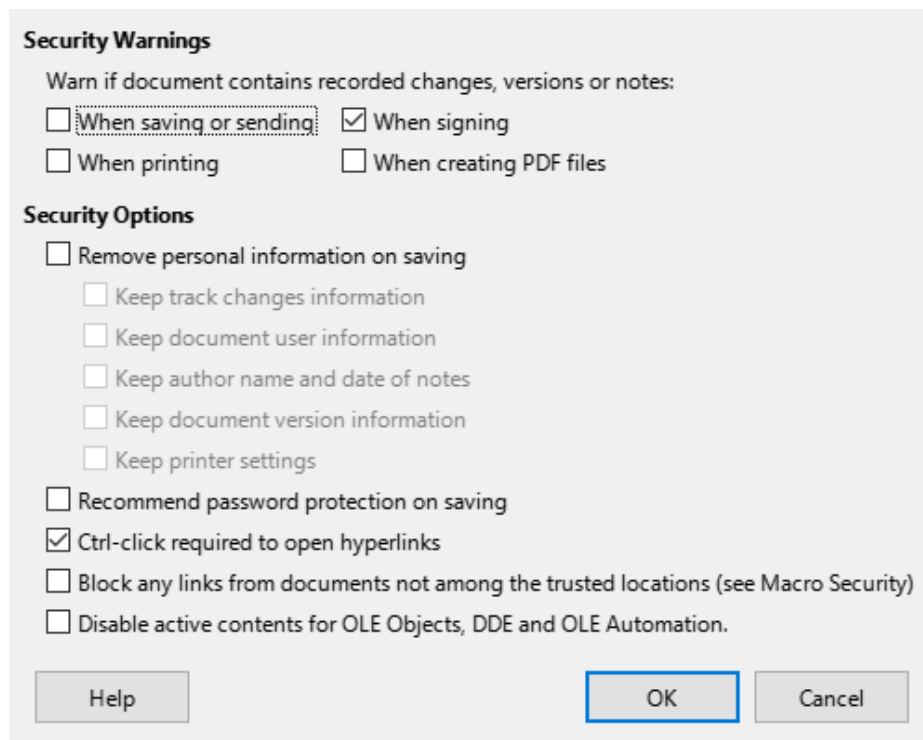

Figure 340: Security Options and Warnings dialog

- 6) Deselect the option **Apply user data** and click on **Reset Properties** to do the following:
 - Removes names in the created and modified fields.
 - Deletes modification and printing dates.
 - Resets editing time to zero, creation date to the current date and time, and version number to 1.
- 7) Click **OK** to close the Properties dialog.
- 8) Go to **File > Versions** on the Menu bar, select the versions from the **Existing Versions** list and click **Delete**. Alternatively, go to **File > Save As** on the Menu bar and save the file with a different name.

Security Warnings

The Security Warnings dialog allows users to set the following options:

When saving or sending

Select to see a warning dialog when saving or sending a document that contains recorded changes, versions, or comments

When printing

Select to see a warning dialog when printing a document that contains recorded changes or comments.

When signing

Select to see a warning dialog when signing a document that contains recorded changes, versions, fields, references to other sources (for example linked sections or linked pictures), or comments.

When creating PDF files

Select to see a warning dialog when you exporting a document to PDF format that displays recorded changes in Writer, or displays comments.

Security Options

Remove personal information on saving

Select to always remove user data from file properties, comments and tracked changes. The names of authors in comments and changes are replaced by generic values as "Author1", "Author2" and so forth. Time values are reset to a single standard value. If this option is not selected, personal information can still be removed for the current document using **Reset Properties** on the General page of the Properties dialog.

Recommend password protection on saving

Select to always enable the **Save with password** option in the file save dialogs. Deselect the option to save files by default without password.

Ctrl-click required to follow hyperlinks

If enabled, hold down the *Ctrl* key (macOS ) while clicking a hyperlink to open the link. If not enabled, a click opens the hyperlink.

Block any links from documents not among the trusted locations (see Macro Security)

Blocks the use of linked images by documents not in the trusted locations defined in **Trusted Sources** of the Macro Security dialog. This can increase security if working with documents from untrusted sources (for example the internet) and are worried about vulnerabilities in image processing software components. Blocking the use of links means that images are not loaded in untrusted documents, only a placeholder frame is visible.

Redaction

LibreOffice documents can be redacted to remove, or hide, any sensitive information allowing selective disclosure of information in a document while keeping other parts of the document secret. When a LibreOffice document is redacted, it is exported as a new PDF file with all the redacted portions removed and replaced by redaction blocks of pixels preventing any attempt to restore or copy the original contents. A redacted document is exported in PDF format for publication, or sharing.

A copy of any documents redacted in LibreOffice Writer, Calc, or Impress are automatically transferred to LibreOffice Draw where the redaction is carried out.

Redaction tools

The tools available on the Redaction toolbar (Figure 341) are as follows:

Rectangle Redaction

Used to mark the content for redaction by drawing transparent rectangles covering the content. Use the handles to resize the redaction rectangle.

Freeform Redaction

Allows the user to mark the content for redaction by drawing free-form lines, or polygons covering the content.

Redacted Export (Black)

Converts the semi-transparent redaction shape to opaque black and exports as pixels in the PDF file.

Redacted Export (White)

Converts the semi-transparent redaction shapes to opaque white shapes and exports as pixels in the PDF file.

Export Preview PDF

Makes a copy of the presentation as a PDF file to preview the redaction areas before making a redacted PDF file of the presentation.

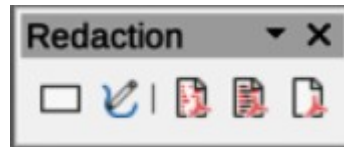

Figure 341: Redaction toolbar

Documents, spreadsheets, or presentations

A copy of a document, spreadsheet, or presentation is automatically transferred to LibreOffice Draw where the redaction is carried out.

- 1) Open the document to be redacted in LibreOffice Writer, Calc or Impress, then go to **Tools > Redact** on the Menu bar and the following happens:
 - The document is copied, prepared and transferred to LibreOffice Draw as an untitled file.
 - LibreOffice Draw opens with the untitled document displayed.
 - The Redaction toolbar automatically opens. If the Redaction toolbar is not displayed, go to **View > Toolbars** on the Menu bar in LibreOffice Draw and select **Redaction**.
- 2) Go to **Tools > Redact** on the Menu bar and click on **Rectangle Redaction** or **Freeform Redaction** in the Redaction toolbar.
- 3) Draw the required shapes to redact the sensitive areas in the document. The redaction shape is gray allowing the sensitive areas in the document to be visible before they are redacted.
- 4) If necessary, click on **Export Preview PDF** to create a preview copy of the PDF file to review the redaction areas before it is finalized.
- 5) If necessary, delete the PDF copy after reviewing the redaction areas in the file.
- 6) Click on **Redacted Export (White)**, or **Redacted Export (Black)** in the Redaction toolbar to export the presentation file as a redacted PDF file.

- 7) Navigate to the folder in the file browser window that opens where the redact PDF file is going to be saved and enter a name for the file.
- 8) Click on **Save** to create the redacted PDF file. The gray redaction shapes are converted to white, or black shapes and the document is exported as a PDF

Drawings

Open a drawing file in Draw, then use Steps 2) through 8) in “Documents, spreadsheets, or presentations” above to create a redacted PDF copy of the drawing file.

Note

When a redacted document is exported as a new PDF file, any redacted areas are removed from the new document and replaced by redacted blocks of pixels. These blocks of pixels prevent any attempt to restore, or copying the original contents that have been redacted.

Automatic redaction

When LibreOffice conducts automatic redaction, it allows the user to define words and patterns that are automatically marked for redaction. Automatic redaction is useful for documents that have multiple occurrences of names and other personal information (for example credit cards, phone numbers, and so on). Manually redacting this type information in a document would require significant effort, but automatic redaction makes redaction of a document easier and more efficient.

Creating targets

Targets are rules and patterns used by automatic redaction to find words and information in a document that are to be marked for automatic redaction.

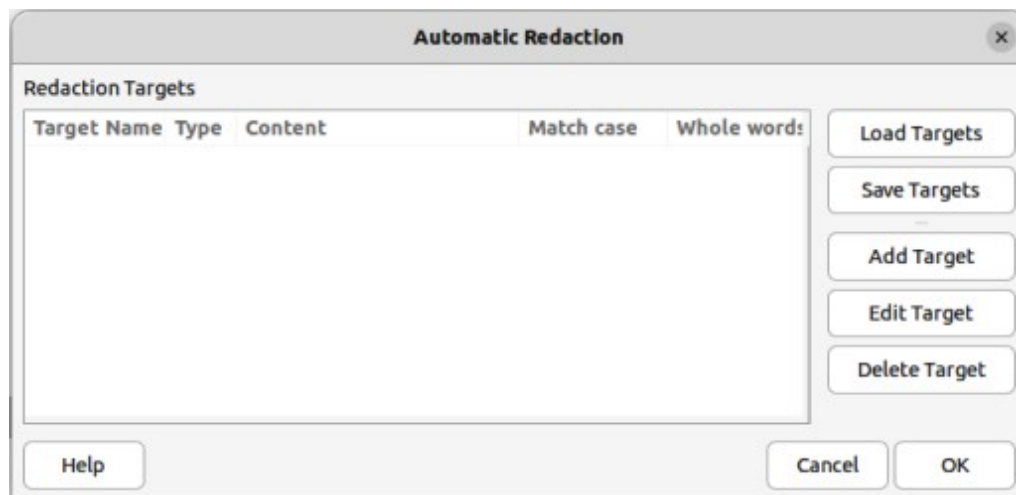

Figure 342: Automatic Redaction dialog

- 1) Open a document and use **Tools > Auto-Redact** on the Menu bar to open the Automatic Redaction dialog (Figure 342).
- 2) Click on **Add Target** to open the Add Target dialog (Figure 343).
- 3) Enter a target name in the **Name** text box.
- 4) Select a target type from the available options in the **Type** drop-down list.

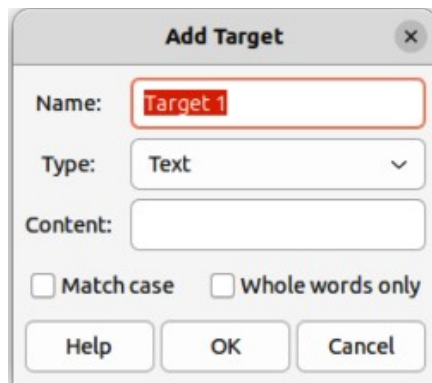

Figure 343: Add Target dialog

- **Text** — automatic redaction looks for all occurrences of the specified text and marks them for redaction.
 - **Regular expression** — define a regular expression for searching in a document. All matches are marked for redaction.
 - **Predefined** — select predefined regular expressions for automatic redaction, such as credit card numbers, email addresses and so on.
- 5) Enter the content in the **Content** text box.
 - 6) If necessary, select the options **Match case** and **Whole words only** to help define which targets are auto-redacted.
 - 7) Click **OK** to close the Add Target dialog and the target is added to the **Redaction Targets** list in the Automatic Redaction dialog.
 - 8) Repeat Steps 2 through 7 above until all targets required have been added to the document.
 - 9) Click **OK** to close the Automatic Redaction dialog. This opens the document as a drawing in LibreOffice Draw with all targets automatically redacted using **Rectangle Redaction**.
 - 10) Print the document, or export the document as a PDF file.

Exporting targets

- 1) Open a document where targets for automatic redaction have been added.
- 2) Go to **Tools > Auto-Redact** on the Menu bar to open the Automatic Redaction dialog.
- 3) Select the targets for export in the Redaction Targets list.
- 4) Click on **Save Targets** to open the Save Targets dialog and navigate to the location where the JSON file is going to be saved.
- 5) Enter a file name for the JSON file in the **File name** text box.
- 6) Click on **Save** to save the JSON file and close the Save Targets dialog.
- 7) Click **OK** to close the Automatic Redaction dialog.

Importing targets

- 1) Open a document where targets for automatic redaction are going to be used.
- 2) Go to **Tools > Auto-Redact** on the Menu bar to open the Automatic Redaction dialog.
- 3) Click on **Load Targets** to open the Load Targets dialog and navigate to the location of the JSON file.

- 4) Select the required file and click on **Open** to import the targets into the document and close the Load Targets dialog.
- 5) Click **OK** to close the Automatic Redaction dialog. This opens the document as a drawing in LibreOffice Draw with all targets automatically redacted using **Rectangle Redaction**.
- 6) Print the document, or export the document as a PDF file.

Note

The automatic redaction targets are saved in a document. The targets are available after the document is saved and closed.

Password protection and OpenPGP encryption

LibreOffice provides two types of document protection: password protection and OpenPGP encryption.

- Files encrypted with the **Save password option** enabled cannot be decrypted without the password.
- Files encrypted with OpenPGP encryption, the document is encrypted using an algorithm, which requires a key. Each key is used only once and is sent to the recipient along with the document.

Password protection

LibreOffice provides two levels of password protection:

- The document file cannot be opened without entering a password.
- The document cannot be edited until a second password is entered.

The two options above make a document available for reading by one group of people and for reading and editing by a different group. This is compatible with Microsoft Word file protection.

Adding passwords

- 1) Go to **File > Save As** on the Menu bar to open the Save as dialog.
- 2) Navigate to the folder where the file is going to be saved.
- 3) If necessary, enter a file name in the **File name** text box and select the file type from the available options in the **File type** drop-down list.
- 4) Select the **Save with password** option, then click on **Save** to open the Set Password dialog (Figure 344).
- 5) In **File Encryption Password**, enter a password to open the document and then enter the same password as confirmation. Passwords are case sensitive. A color password strength meter appears below the password box, where red is for weak passwords, yellow is just a bit better, blue is even better and green is a secure password.
- 6) Click on **Options** to open **File Sharing Password**.
- 7) Select **Open file read-only** to prevent any editing being carried out on the document.
- 8) To allow editing of the document, enter a password in **Enter password to allow editing** and repeat the password as confirmation.
- 9) Click **OK** and the Set Password dialog closes and the file is saved with password protection.

File Encryption Password

Enter password to open

...

Confirm password

Note: After a password has been set, the document will only open with the password. Should you lose the password, there will be no way to recover the document. Please also note that this password is case-sensitive.

Options

File Sharing Password

Open file read-only

Enter password to allow editing

Confirm password

OK Cancel

Figure 344: Set Password dialog

Notes

If the passwords match, the document is saved password protected. If either the passwords do not match, an error message is displayed.

LibreOffice uses a very strong encryption mechanism that makes it almost impossible to recover the contents of a document if the password is lost or forgotten.

Changing passwords

When a document is password protected, the password can be changed while the document is open.

- 1) Go to **File > Properties > General** on the Menu bar to open the Properties dialog.
- 2) Click on **Change Password** to open the Set Password dialog.
- 3) Enter a new password to open the file and to allow editing of the document.
- 4) Click **OK** to close the Set Password dialog.
- 5) Click **OK** again to close the Properties dialog.

OpenPGP encryption

LibreOffice can encrypt documents confidentially using OpenPGP. The document is encrypted using a symmetric encryption algorithm, which requires a symmetric key. Each symmetric key is used only once and is also called a session key. The document and its session key are sent to the recipient. The session key must be sent to the recipients so they know how to decrypt the document. To protect the document during transmission, it is encrypted with the public key belonging to the recipient. Only the private key belonging to the recipient can decrypt the session key. For more information on using OpenPGP encryption, go to the LibreOffice Help website.

LibreOffice uses the OpenPGP software installed on a computer. If no OpenPGP software is available, download and install OpenPGP software that is compatible with the computer operating system before using OpenPGP encryption.

A personal pair of cryptography keys must be defined using the OpenPGP software. Refer to the OpenPGP software installed on how to create a pair of keys.

OpenPGP encryption requires the use of the public key belonging to the recipient. This key must be available in the OpenPGP key chain stored in the computer.

The following is an example of how to use OpenPGP encryption on a document:

- 1) Set the preferred public key for OpenPGP encryption and digital signature. This preferred key is pre-selected in the key selection dialog each time a document is signed or encrypted. This removes the requirement to select the preferred key when frequently signing a document with one specific key.
- 2) Go to **Tools > Options > LibreOffice > User Data** (macOS **LibreOffice > Preferences > LibreOffice > User Data**) on the Menu bar and select the following options in the **Cryptography** section:
 - **OpenPGP signing key** — select an OpenPGP key from the drop-down list for signing ODF documents.
 - **OpenPGP encryption key** — select an OpenPGP key from the drop-down list for encrypting ODF documents.
 - **When encrypting documents, always encrypt to self** — select this option to also encrypt the file with a public key, allowing the document to be opened with a private key.

Caution

Keep this option selected to allow decryption of documents that have been encrypted for other people. If not selected, you will not be able to decrypt your own files.

- 3) Go to **File > Save As** on the Menu bar to open the Save as dialog.
- 4) Navigate to the required location for the file, then enter a file name and file type in the Save as dialog.
- 5) Select **Encrypt with GPG key** option and click on **Save** to open the Select X.509 Certificate dialog.
- 6) Select the public key for the recipient. Multiple keys can be selected.
- 7) Click **Encrypt** to close the dialog and save the file encrypted with the selected public keys.



LibreOffice
Community



Chapter 11, Getting Started with Macros

Using the Macro Recorder ... and Beyond

Introduction

A macro is a set of commands or keystrokes that are stored for later use. For example, a simple macro allows you to enter your address into an open document and a macro can automate both simple and complex tasks. Macros are very useful when you have to repeat the same task in the same way.

The simplest way to create a macro is to record a series of actions with LibreOffice's user interface via the open source LibreOffice Basic scripting language (an implementation of the well-known BASIC programming language). These macros can be edited and enhanced after recording with the built-in LibreOffice Basic Integrated Development Environment (IDE).

The most powerful macros in LibreOffice can be created with one of the four supported scripting languages (LibreOffice Basic, Python, JavaScript, and BeanShell). This chapter provides an overview of LibreOffice's macro facilities with an emphasis on its default macro scripting language, LibreOffice Basic. Though some introductory examples are included for the BeanShell, JavaScript, and Python scripting languages, an in-depth discussion on using these languages for scripting is beyond the scope of this chapter.

Your first macros

Adding a macro

To start with LibreOffice macros, we recommend that you find and use existing macros. We assume that you have an existing macro that you want to use, which was originally found in a book or on the internet. In this example, the macro in Listing 1 is used. Once you have a macro, you create a library and module to contain your macro; the creation of a macro library is below, but see "Macro organization" on page 478 for more information.

Listing 1: Simple macro that says hello

```
Sub HelloMacro
  Print "Hello"
End Sub
```

Use the following steps to create a library that will contain your macro:

- 1) Open any LibreOffice application.
- 2) Go to **Tools > Macros > Organize Macros > Basic** to open the Basic Macros dialog (Figure 345).

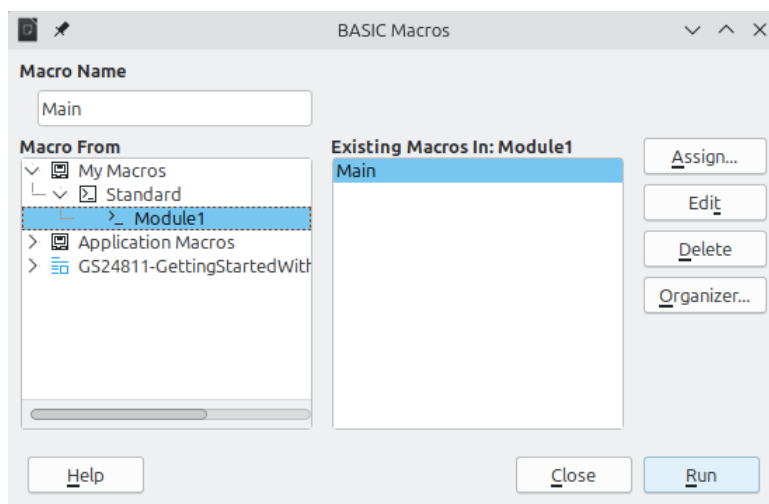

Figure 345: Basic Macros dialog

- 3) Click **Organizer** to open the Basic Macro Organizer dialog (Figure 346) and select the *Libraries* tab.

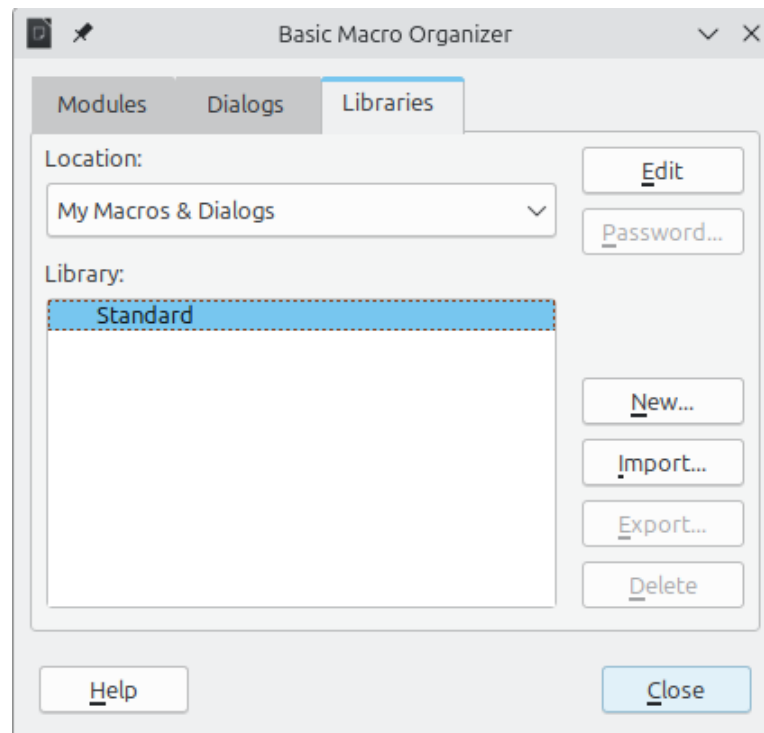

Figure 346: LibreOffice Basic Macro Organizer dialog, Libraries tab

- 4) Set the *Location* drop-down to **My Macros & Dialogs**, which is the default location.
- 5) Click **New** to open the New Library dialog (not shown here).
- 6) Enter a library name, for example *TestLibrary*, and click **OK**.
- 7) On the Basic Macro Organizer dialog, select the *Modules* tab (Figure 347).

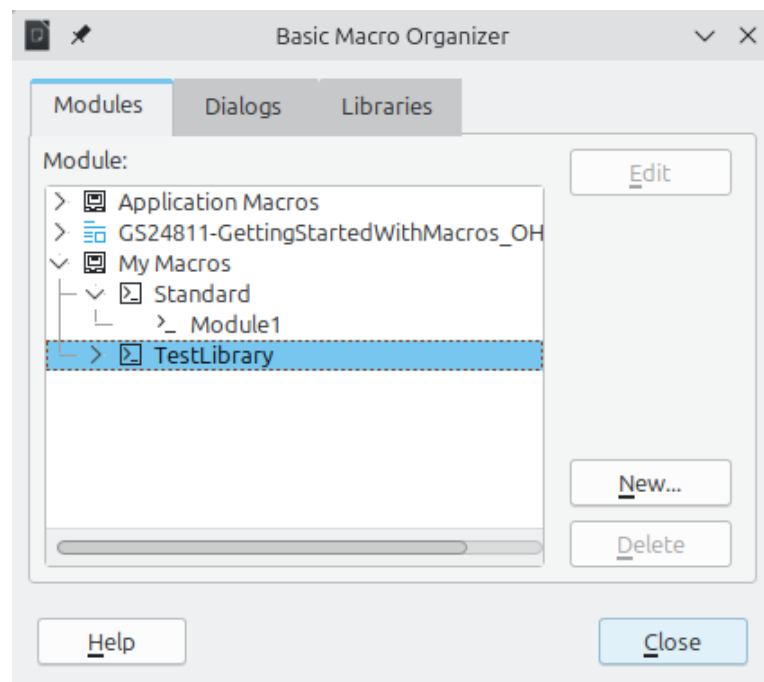

Figure 347: Basic Macro Organizer dialog, Modules tab

- 8) In the *Module* list, expand *My Macros* and select your library (in the example, *TestLibrary*). A module named *Module1* already exists and can contain your macro. If you wish, you can click **New** to create another module in the library.
- 9) Select *Module1*, or the new module that you created, and click **Edit** to open the Integrated Development Environment (IDE) (Figure 348). The IDE is a text editor and associated facilities that are built into LibreOffice and allow you to create, edit, run, and debug macros.
- 10) When a new module is created, it contains a comment and an empty macro named *Main*, which does nothing.
- 11) If you are ready, add the new macro either before *Sub Main* or after *End Sub*. Listing 2 shows the new macro added before *Sub Main*.

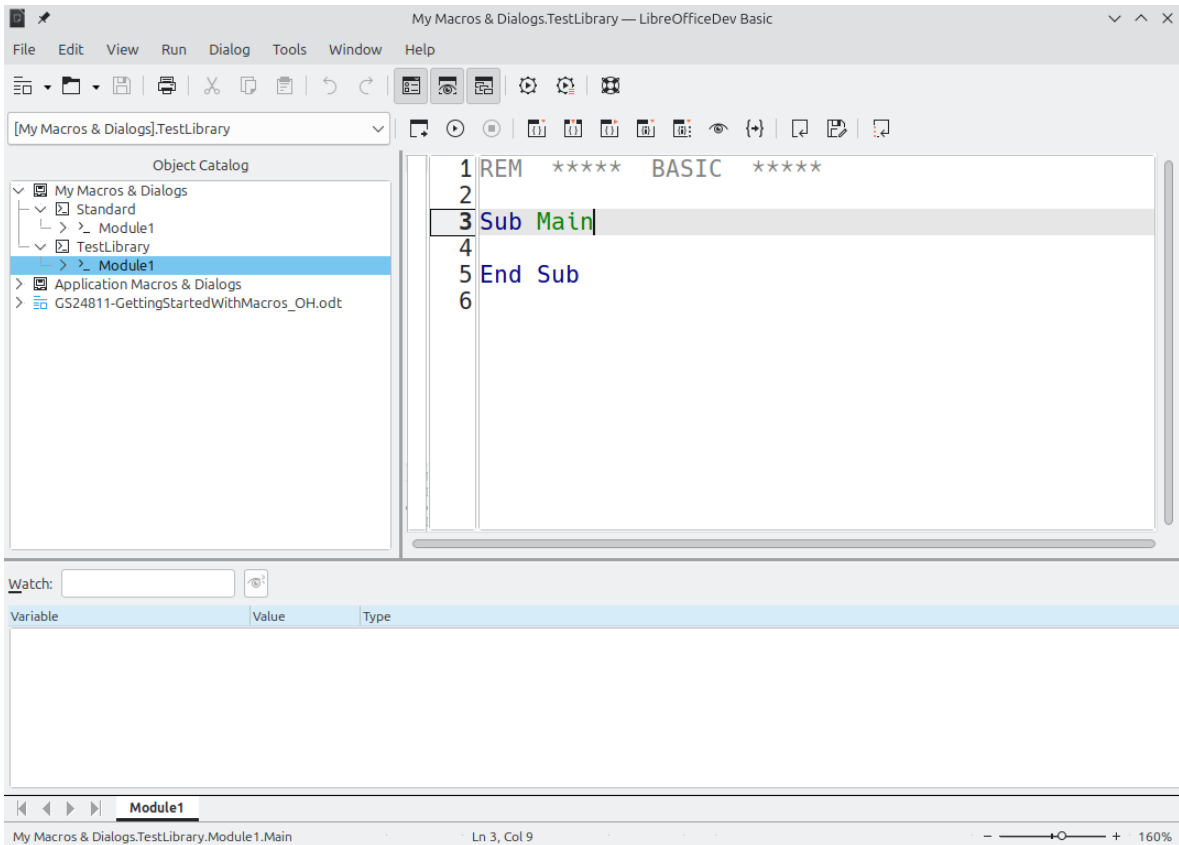

Figure 348: LibreOffice Basic IDE (Integrated Development Environment) window

Listing 2: Module1 after adding the new macro

```
REM ***** BASIC *****

Sub HelloMacro
  Print "Hello"
End Sub

Sub Main
End Sub
```



Tip

If you prefer, you can remove the *Sub Main ... End Sub* code from the Module and leave only the *HelloMacro* subroutine.

- 12) (Optional) To check if the macro is written as expected by the LibreOffice Basic programming language, click the **Compile** icon on the Macro toolbar.
- 13) Double-click the HelloMacro subroutine in the *Object Catalog* window under *TestLibrary > Module 1* and click the **Run** icon on the Macro toolbar, or press the *F5* key, to run the HelloMacro subroutine in the module. A small dialog will open with the word “Hello” displayed (see below).

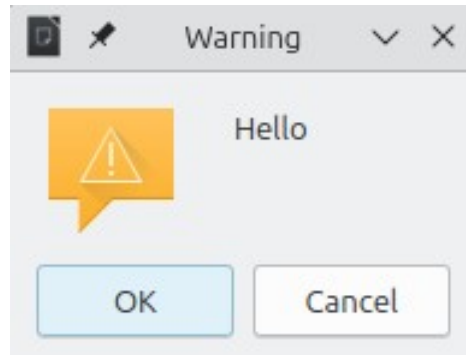

Figure 349: Dialog with results of the Print instruction.

- 14) Click **OK** to close this small dialog.
- 15) If no subroutine or function is selected, a dialog like the one in Figure 350 will open. Then select the macro and click **Run** to execute it.
- 16) To select and run any macro in the module, click the **Select Macro** icon on the Standard toolbar or go to **Tools > Macros > Organize Macros > Basic**.
- 17) Select a macro and then click **Run**.

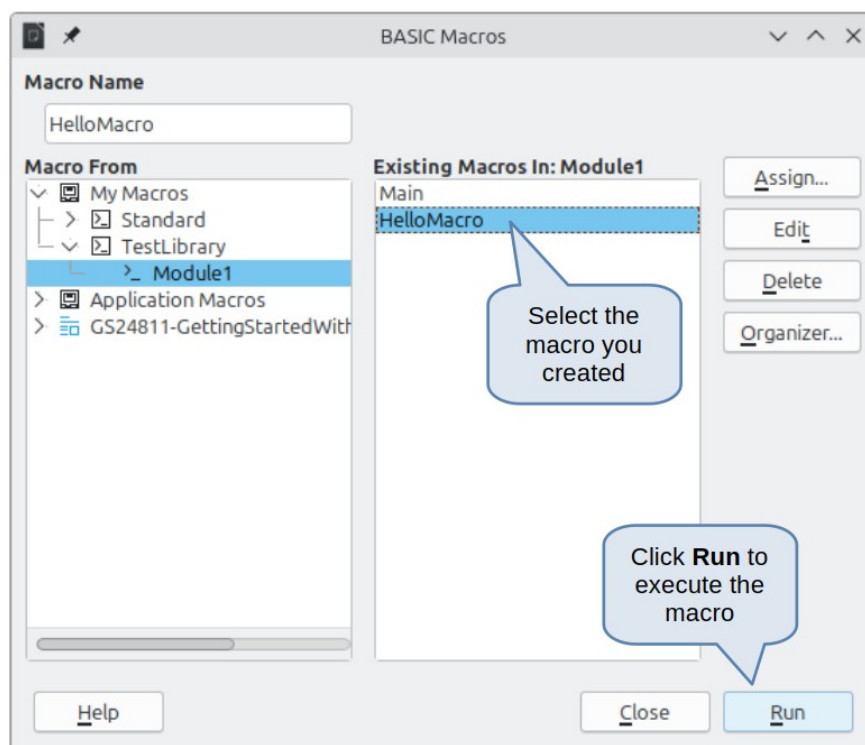

Figure 350: Dialog to select and run a macro

Recording a macro

When you record a macro in LibreOffice, you are actually using programming language to record the steps needed to perform a certain task. For example, if you have to repeatedly enter the same information into a document, you can create a macro that automatically enters this piece of information without having to copy it every time you need it.

Note

Sometimes, it might be better to create an AutoText that can repeatedly enter information into a document. See Chapter 2, *Working with Text: Basics*, in the *Writer Guide* for more information.

First enable macro recording in LibreOffice by going to **Tools > Options > LibreOffice > Advanced** and selecting the option **Enable macro recording** under *Optional Features*. By default, this feature is turned off in LibreOffice.

- 1) Go to **Tools > Macros > Record Macro** to start recording a macro. A small dialog with a **Stop Recording** button is displayed indicating that LibreOffice is recording a macro.
- 2) Type the desired text you want to be entered when this macro is run. As an example, type your name.
- 3) Click **Stop Recording** on the small dialog. This will cause Basic Macros dialog to open (similar to Figure 345 on page 465, but with different action buttons).
- 4) Open the library container *My Macros*.
- 5) Find the library named *Standard* in *My Macros*. Note that every library container has a library named *Standard*.
- 6) Select the *Standard* library and then choose an existing module in which to save the macro. Alternatively you can click **New Module** to create a new module to contain the newly recorded macro.
- 7) In the **Macro Name** text box at the top left section of the dialog, type a name for the macro you have just recorded, for example `EnterMyName`.
- 8) Click **Save** to save the macro and close the Basic Macros dialog.

If you followed all of the above steps, a macro named *EnterMyName* will have been created inside the selected module.

Note

Whenever you create a new module in LibreOffice, a subroutine named *Main* is automatically added to the module.

Running a macro

- 1) Go to **Tools > Macros > Run Macro** to open the Macro Selector dialog (Figure 351).
- 2) For example, select your newly created macro *EnterMyName* and click **Run**.
- 3) Alternatively, go to **Tools > Macros > Organize Macros > Basic** to open the Basic Macros dialog (Figure 345), select your macro and click **Run**.

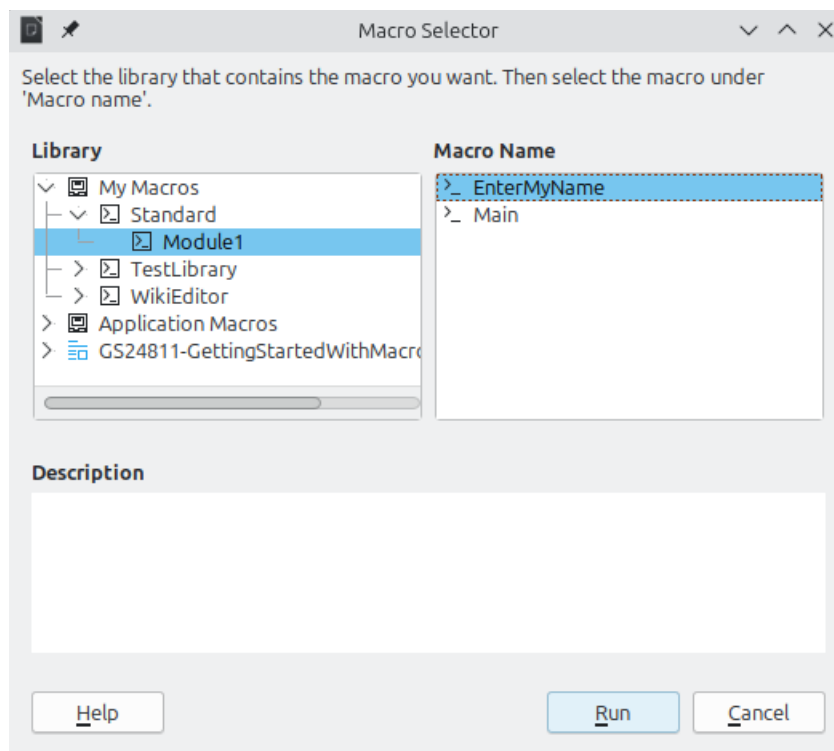

Figure 351: Use the Macro Selector dialog to select and run an existing macro

Viewing and editing macros

To view and edit the macro that you created:

- 1) Go to **Tools > Macros > Organize Macros > Basic** to open the Basic Macros dialog.
- 2) Select your new macro *EnterMyName* and click **Edit**. The Basic IDE will open and the macro *EnterMyName* will be shown as in Listing 3.

This first macro is not complicated (see Listing 3):

Listing 3: Code recorded for the EnterMyname macro

```
sub EnterMyName
rem -----
rem define variables
dim document as object
dim dispatcher as object
rem -----
rem get access to the document
document = ThisComponent.CurrentController.Frame
dispatcher = createUnoService("com.sun.star.frame.DispatchHelper")
rem -----
dim arg1(0) as new com.sun.star.beans.PropertyValue
arg1(0).Name = "Text"
arg1(0).Value = "Your name"
dispatcher.executeDispatch(document, ".uno:InsertText", "", 0, arg1())
end sub
```

Commenting with REM

All comments in Basic macro coding begin with REM, which stands for remark. All text on a line that begins with REM is ignored by the Basic interpreter when the macro is run.



Tip

As a shortcut, you can use the single quote character (') to start a comment.

LibreOffice Basic is not case-sensitive for keywords, so REM, Rem, and rem can all start a comment. If you use symbolic constants defined by the Application Programming Interface (API), it is safer to assume that the names are case-sensitive. It is worth noting that symbolic constants are an advanced topic that is not covered by this user guide and they are not required when using the macro recorder in LibreOffice.

Defining subroutines with SUB

Individual macros are stored in subroutines and these subroutines begin with the keyword SUB. The end of a subroutine is indicated by the words END SUB. The code starts by defining the subroutine named Main, which is empty and does nothing. Note that the code in Listing 3 for the EnterMyName macro starts with the keyword SUB and ends with END SUB.

There are advanced topics that are beyond the scope of this user guide, but knowing about them might be of interest:

- You can write subroutines that accept input values to be used inside the macro. These values are called arguments. This can only be done when you create subroutines from scratch. Recorded macros in LibreOffice do not accept arguments.
- Another kind of subroutine is called a function, which is a subroutine that can return a value as a result of its work. Functions are defined by the keyword FUNCTION at the beginning. Recorded macros in LibreOffice create subroutines only.

Defining variables using DIM

When you are defining a variable (which contains data), you should use the DIM keyword, which was originally stood for *Dimension* and was used to define the dimensions of an array. The DIM statement used in the EnterMyName macro is similar to setting aside a piece of paper to be used to store a message or note.

In the EnterMyName macro, the variables document and dispatcher are defined as the type object. Other common variable types include string, integer, and date. A third variable, named args1, is an array of property values. A variable of type array allows a single variable to contain multiple values, similar to storing multiple pages in a single book. Values in an array usually begin at zero. The number in the parentheses indicates the highest usable number to access a storage location. In this example, there is only one value, and it is numbered zero.

Explaining macro code

The following is an explanation of the code used in the EnterMyName macro.

```
sub EnterMyName
```

Defines the start of the EnterMyName macro.

```
dim document as object
```

Defines document as an object variable. Objects are a specific variable type with multiple fields (sometimes they are called properties) and actions (also they are called methods). The fields can be perceived like variables (including an object) and actions like subroutines which allow us to operate with the object.



Note

Sometimes the word *service* is used. A service is supplied by an object when a macro commands it via an object's method.

```
dim dispatcher as object
```

Defines `dispatcher` as an object variable.

```
document = ThisComponent.CurrentController.Frame
```

`ThisComponent` is a runtime object created by LibreOffice that refers to the current document.

`CurrentController` is a property referring to a service that controls the document. For example, when you type, it is the current controller that takes note of what you type. `CurrentController` then dispatches the changes to the document frame.

`Frame` is a controller property that returns the main frame for a document. Therefore, the variable named `document` refers to a document's frame, which receives dispatched commands.

```
dispatcher = createUnoService("com.sun.star.frame.DispatchHelper")
```

Most tasks in LibreOffice are accomplished by dispatching a command. LibreOffice includes a `DispatchHelper` service, which provides an easy way to dispatch a URL using one call instead of multiple ones and does most of the work when using dispatches in macros. The method `CreateUnoService` accepts the name of a service and it tries to create an instance of that service. On completion, the `dispatcher` variable contains a reference to a `DispatchHelper`.

```
dim args1(0) as new com.sun.star.beans.PropertyValue
```

Declares the `args1` array of properties. Each property has a name and a value. In other words, it is a name/value pair. The created array has one property at index zero.

The `com.sun.star.beans.PropertyValue` expression is a Universal Network Objects (UNO) structure. Structures are special variable types that contain other variables united by logical basis. They can be convenient to operate with sets of heterogeneous information that should be treated as a single whole.

NOTE

An explanation of UNO and user structures goes far beyond the scope of this book. For more information on creating and using structures, see the LibreOffice Help system and other Basic guides.

```
args1(0).Name = "Text"  
args1(0).Value = "Your name"
```

Gives the property the name "Text" and the value "Your name", which is the text that is inserted when the macro is run.

```
dispatcher.executeDispatch(document, ".uno:InsertText", "", 0, args1())
```

The dispatch helper sends a dispatch to the document frame (stored in the variable `document`) with the command `.uno:InsertText`. The next two arguments, frame name and search flags, are beyond the scope of this book. The last argument is the array of property values to be used while executing the command `InsertText`.

In other words, this line of code executes the UNO command `.uno:InsertText` passing the value "Your Name" as the "Text" parameter.

```
end sub
```

The last line of the code ends the subroutine.

Creating a macro

When creating a macro, it is important to ask two questions before recording:

- 1) Can the task be written as a simple set of commands?
- 2) Can the steps be arranged so that the macro's final command leaves the cursor ready for the next command? Or does it allow the user to return to entering text or data into the target document?

A more complex example of a macro

One common macro task is to copy rows and columns of data from a website and format them as a table in a text document. Typically this macro works as follows:

- 1) Copy the data from the website to the clipboard.
- 2) To avoid strange formatting and fonts, paste the text into a Writer document as unformatted text.
- 3) Reformat the text with tabs between columns so that it can be converted into a table using **Table > Convert > Text to Table**.

With the two questions above in mind, inspect the text to see you can record a macro that formats the text. As an example of copied data, consider the text copied from the API website describing the FontWeight constants (Figure 352). The first column in this example indicates a constant name and each name is followed by a space and a tab, and each line has two trailing spaces.

DONTKNOW	The font weight is not specified/known.
THIN	specifies a 50% font weight.
ULTRALIGHT	specifies a 60% font weight.
LIGHT	specifies a 75% font weight.
SEMILIGHT	specifies a 90% font weight.
NORMAL	specifies a normal font weight.
SEMIBOLD	specifies a 110% font weight.
BOLD	specifies a 150% font weight.
ULTRABOLD	specifies a 175% font weight.
BLACK	specifies a 200% font weight.

Figure 352: Example of copied data

In this example we will want the first column in the table to contain the numeric value of the font weight, the second column will contain the constant name, and the third column will hold the text description. This task can be accomplished easily for every row except for DONTKNOW and NORMAL, which do not contain a numeric value.

Below are the steps to record this macro using keystrokes and assuming that the cursor is at the beginning of the line with the text "THIN".

- 1) Make sure macro recording is enabled by going to **Tools > Options > LibreOffice > Advanced** and selecting the option **Enable macro recording**. By default, this feature is turned off when LibreOffice is installed on your computer.
- 2) Go to **Tools > Macros > Record Macro** to start recording.
- 3) Press *Ctrl+Right Arrow* to move the cursor to the start of the word "specifies".
- 4) Press *Backspace* twice to remove the tab and the space.
- 5) Press *Tab* to add the tab without the space after the constant name.

- 6) Press *Delete* to delete the lower case “s” and then press *Shift+S* to add an upper case “S”.
- 7) Press *Ctrl+Right Arrow* twice to move the cursor to the start of the number.
- 8) Press *Ctrl+Shift+Right Arrow* to select and move the cursor before the % sign.
- 9) Press *Ctrl+C* to copy the selected text to the clipboard.
- 10) Press *End* to move the cursor to the end of the line.
- 11) Press *Backspace* twice to remove the two trailing spaces.
- 12) Press *Home* to move the cursor to the start of the line.
- 13) Press *Ctrl+V* to paste the selected number to the start of the line.
- 14) Pasting the value also pasted an extra space, so press *Backspace* to remove the extra space.
- 15) Press *Tab* to insert a tab between the number and the name.
- 16) Press *Home* to move to the start of the line.
- 17) Press *Down Arrow* to move to the next line.
- 18) Stop recording the macro and save the macro, see “Recording a macro” on page 469.

It takes much longer to read and write these steps than to actually record the macro. Work slowly and think about the steps as you do them. With practice you will learn how to organize the steps into macros that can be used to automate repetitive tasks.

The generated macro code in Listing 4 has been modified to contain the step numbers in the comments to match the steps discussed above.

Listing 4: Copying numeric value to start of the column

```

sub CopyNumToCol1
rem -----
rem define variables
dim document as object
dim dispatcher as object
rem -----
rem get access to the document
document = ThisComponent.CurrentController.Frame
dispatcher = createUnoService("com.sun.star.frame.DispatchHelper")

rem (3) Press Ctrl+Right Arrow to move the cursor to the start of "specifies".
dispatcher.executeDispatch(document, ".uno:GoToNextWord", "", 0, Array())

rem (4) Press Backspace twice to remove the tab and the space.
dispatcher.executeDispatch(document, ".uno:SwBackspace", "", 0, Array())

rem -----
dispatcher.executeDispatch(document, ".uno:SwBackspace", "", 0, Array())

rem (5) Press Tab to add the tab without the space after the constant name.
dim args4(0) as new com.sun.star.beans.PropertyValue
args4(0).Name = "Text"
args4(0).Value = CHR$(9)

dispatcher.executeDispatch(document, ".uno:InsertText", "", 0, args4())

rem (6) Press Delete to delete the lower case s ....

```

```

dispatcher.executeDispatch(document, ".uno:Delete", "", 0, Array())

rem (6) ... and then press Shift+S to add an upper case S.
dim args6(0) as new com.sun.star.beans.PropertyValue
args6(0).Name = "Text"
args6(0).Value = "S"

dispatcher.executeDispatch(document, ".uno:InsertText", "", 0, args6())

rem (7) Press Ctrl+Right Arrow twice to move the cursor to the number.
dispatcher.executeDispatch(document, ".uno:GoToNextWord", "", 0, Array())

rem -----
dispatcher.executeDispatch(document, ".uno:GoToNextWord", "", 0, Array())

rem (8) Press Ctrl+Shift+Right Arrow to select the number.
dispatcher.executeDispatch(document, ".uno:WordRightSel", "", 0, Array())

rem (9) Press Ctrl+C to copy the selected text to the clipboard.
dispatcher.executeDispatch(document, ".uno:Copy", "", 0, Array())

rem (10) Press End to move the cursor to the end of the line.
dispatcher.executeDispatch(document, ".uno:GoToEndOfLine", "", 0, Array())

rem (11) Press Backspace twice to remove the two trailing spaces.
dispatcher.executeDispatch(document, ".uno:SwBackspace", "", 0, Array())

rem -----
dispatcher.executeDispatch(document, ".uno:SwBackspace", "", 0, Array())

rem (12) Press Home to move the cursor to the start of the line.
dispatcher.executeDispatch(document, ".uno:GoToStartOfLine", "", 0, Array())

rem (13) Press Ctrl+V to paste the selected number to the start of the line.
dispatcher.executeDispatch(document, ".uno:Paste", "", 0, Array())

rem (14) Press Backspace to remove the extra space.
dispatcher.executeDispatch(document, ".uno:SwBackspace", "", 0, Array())

rem (15) Press Tab to insert a tab between the number and the name.
dim args17(0) as new com.sun.star.beans.PropertyValue
args17(0).Name = "Text"
args17(0).Value = CHR$(9)

dispatcher.executeDispatch(document, ".uno:InsertText", "", 0, args17())
rem (16) Press Home to move to the start of the line.
dispatcher.executeDispatch(document, ".uno:GoToStartOfLine", "", 0, Array())

rem (17) Press Down Arrow to move to the next line.
dim args19(1) as new com.sun.star.beans.PropertyValue
args19(0).Name = "Count"
args19(0).Value = 1
args19(1).Name = "Select"
args19(1).Value = false

dispatcher.executeDispatch(document, ".uno:GoDown", "", 0, args19())
end sub

```

To run this macro, place the cursor at the beginning of the line to which you want to apply the recorded steps. Then go to **Tools > Macros > Run Macro**, select the *CopyNumToCol1* macro and click **Run**. Figure 353 shows the original line and the resulting line after applying the macro.

Original Line (before running the macro)

THIN specifies a 50% font weight.

To run the macro, place the cursor at the beginning of the line

New Line (after running the macro)

50 THIN Specifies a 50% font weight.

This is the resulting line after running the macro

Figure 353: Result of applying the recorded macro

Keep in mind that the steps described above will only work properly if the first line follows the format we assumed while creating the macro. If you run this macro on the “DONTKNOW” and “NORMAL” lines the results will not be as expected because these two lines have different formats. Figure 354 shows the original line starting with “DONTKNOW”.

Original Line not following the assumed structure

DONTKNOW The font weight is not specified/known.

Running the macro on a line with a different structure

weight DONTKNOWShe font weight is not specified/known.

Figure 354: Result of using the macro in a line with a different structure

Running a macro quickly

Since it is not convenient to repeatedly run macros using **Tools > Macros > Run Macro**, you can assign a keyboard shortcut to quickly trigger it. To assign the shortcut *Ctrl+K* to the *CopyNumToCol1* macro, do the following:

- 1) Go to **Tools > Customize**. This will open the Customize dialog.
- 2) Select the *Keyboard* tab. In the *Shortcut Keys* section, select the *Ctrl+K* shortcut.
- 3) In the *Category* section, select *LibreOffice macros*. Navigate this section and select the *CopyNumToCol1* macro.
- 4) Now click the **Assign** button to assign the *Ctrl+K* shortcut to the *CopyNumToCol1* macro.
- 5) Click **OK** to close the *Customize* dialog.

Now you can run the *CopyNumToCol1* macro using the *Ctrl+K* shortcut. This is very fast and easy to configure after you get used to the macro workflow. Figure 355 illustrates the steps involved.

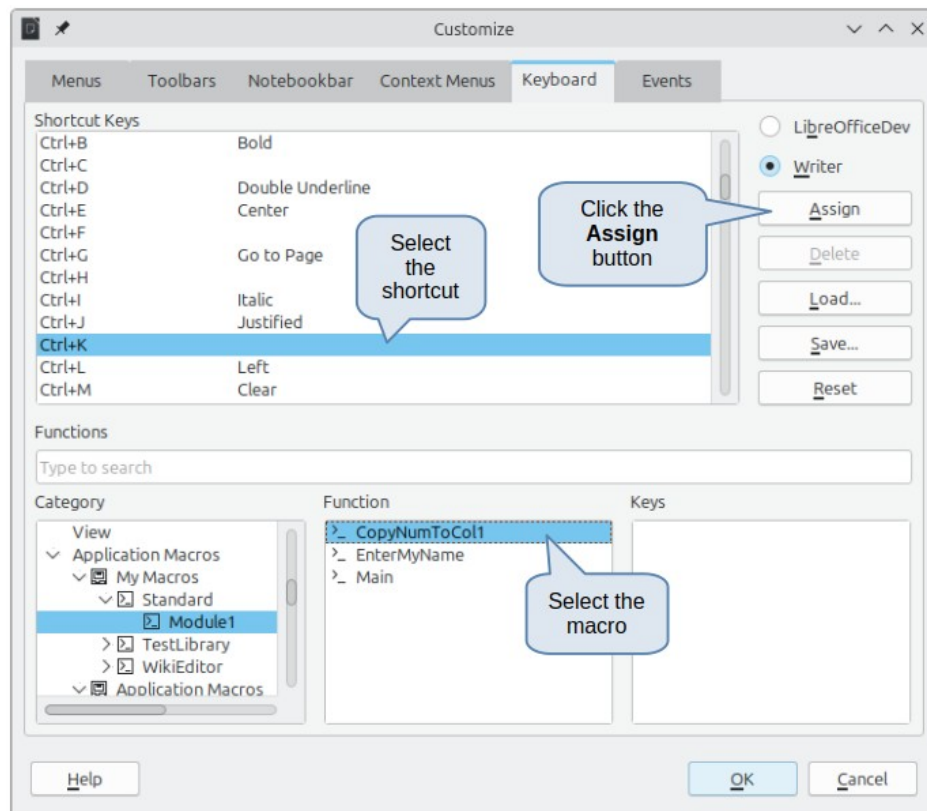

Figure 355: Assigning a shortcut to a macro

Limitations of the macro recorder

Unfortunately, the *Macro Recorder* cannot record some actions, and its limitations are related to LibreOffice's dispatch framework and its relationship to the macro recorder.

Understanding the dispatch framework

The purpose of the dispatch framework is to provide uniform access to components (documents) for commands that generally correspond to menu items. It translates **File > Save**, the shortcut keys *Ctrl+S*, or clicking the **Save** icon on the Standard toolbar into the same “dispatch command.”

Also, the dispatch framework can send “commands” back to the user interface (UI). For example, after saving a new document, the framework makes sure that the list of recent files is updated.

A dispatch command is text, for example `.uno:InsertObject` or `.uno:GoToStartOfLine`. The command is sent to the document frame and the frame the command around the API until an object is found that can handle the command.

How the macro recorder uses the dispatch framework

The macro recorder can only register commands generated by the dispatch framework, but not all dispatched commands are complete. For example, inserting an object generates the following code:

```
dispatcher.executeDispatch(document, ".uno:InsertObject", "", 0, Array())
```

It is not possible to specify what kind of object to create or insert. If an object is inserted from a file, you cannot specify which file to insert.

If while recording a macro you use **Tools > Options** to open and modify configuration items, the generated macro does not record any configuration changes. In fact, the generated code is commented so it will not even be run.

```
rem dispatcher.executeDispatch(document, ".uno:OptionsTreeDialog", "", 0, Array())
```

Though a command is generated when you open a dialog, any work done inside the dialog is not usually recorded. This occurs in places like macro organization dialogs, when you are inserting special characters, and similar types of dialogs. Other possible problems using the macro recorder can occur when you insert a formula, set user data, create filters in Calc, do actions in database forms, and export a document to an encrypted PDF file. You never know for certain what the macro recorder can capture until you try it. For example, the actions from the search dialog are properly captured.

Other options

When the macro recorder is not able to solve a specific problem, normally the next step is to write actual code using the LibreOffice objects. Unfortunately, there is a steep learning curve for these LibreOffice objects. It is usually best to start with simple examples and then increase the scope of macros as you learn more. Learning to read generated macros is a good place to start.

Macro organization

In LibreOffice, macros are grouped in modules, modules are grouped in libraries, and libraries are grouped in library containers. A library is usually used as a major grouping for either an entire category of macros, or for an entire application. Modules usually split functionality, such as user interaction and calculations. Individual macros are subroutines and functions. Figure 356 shows an example of the hierarchical structure of macro libraries in LibreOffice.

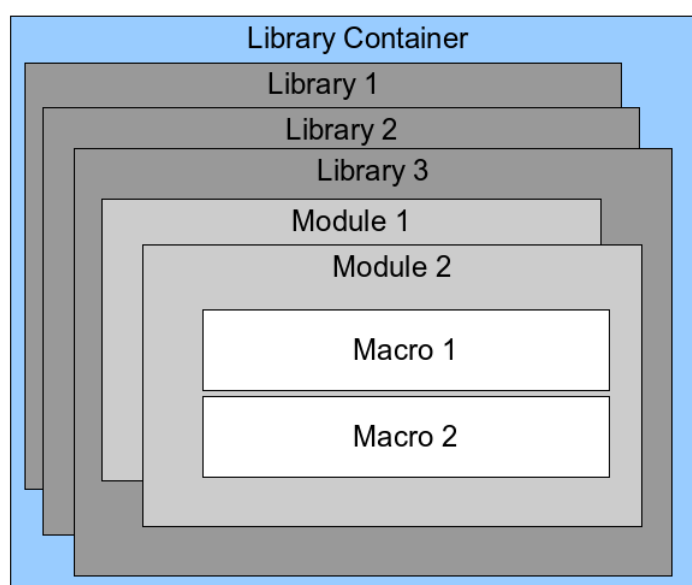

Figure 356: Macro Library hierarchy

Go to **Tools > Macros > Organize Macros > Basic** to open the Basic Macros dialog (Figure 345 on page 465). All available library containers are shown in the *Macro From* list and every document is a library container, capable of containing multiple libraries. The application itself acts as two library containers, one container for macros distributed with LibreOffice called *LibreOffice Macros*, and one container for personal macros called *My Macros*.

The *LibreOffice Macros* are stored with the application runtime code, which may not be editable to you unless you have administrator rights in LO. This helps protect these macros because they

should not be changed and you should not store your own macros in the *LibreOffice Macros* container.

Unless your macros are only applicable to a single document, your macros will probably be stored in the *My Macros* container. The *My Macros* container is stored in your user area or home directory.

If a macro is contained in a document, then a recorded macro will attempt to work on that document, because it primarily uses *ThisComponent* for its actions.

Every library container contains a library named *Standard*. We strongly recommend that you create your own libraries with meaningful names instead of using the *Standard* library. Libraries with meaningful names are easier to manage and unlike *Standard*, your own libraries can be imported into other library containers.

Caution

While LibreOffice allows you to import libraries into a library container, it will not allow you to overwrite the library named *Standard*. Therefore, if you store your macros in the *Standard* library, you cannot import them into another library container.

Just as it makes good sense to give your libraries meaningful names, you should use meaningful names for your modules. By default, LibreOffice uses names such as *Module1*, *Module2*, and so on.

As you create your macros, you must decide where to store them. Macros stored in the application library container named *My Macros* are globally available to all documents and storing a macro in a document is useful if the document will be shared and you want the macro to be included with the document.

While the *Standard* and *Template* libraries are automatically loaded, other library macros are not available until the library that contains them is loaded. A loaded library is displayed differently from a library that is not loaded. To load the library and the modules it contains, double-click on the library.

Where are macros stored?

LibreOffice stores user-specific data in a folder inside the user's home directory. The location is operating system specific. To find out where configuration data is stored, go to **Tools > Options > LibreOffice > Paths**. User macros written in Basic are stored in `LibreOffice\4\user\basic`. Each library is stored in its own directory inside the `basic` directory.

For casual use, it is not necessary to understand where macros are stored. If you know where they are stored, however, you can create a backup, share your macros, or inspect them if there is an error.

Exporting macros

If you want to export macro libraries so that they can be reused and shared with other people, use the LibreOffice Basic Macro Organizer. To export a macro library:

- 1) Go to **Tools > Macros > Organize Macros > Basic** and click the **Organizer** button.
- 2) Click the *Libraries* tab and choose which library you want to export.
- 3) Click **Export** and then select **Export as BASIC Library** (note that you cannot export the *Standard* library).
- 4) Choose where you want to save the library and click **Save**.

When a library is exported, LibreOffice creates a folder containing all files related to the library. Figure 357 shows an example of how a library named *TestLibrary* with a single module called *Module1* would be exported.

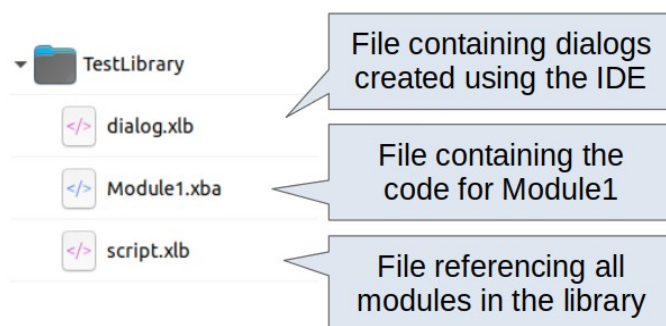

Figure 357: Folder containing the exported library

Importing macros

The LibreOffice Basic Macro Organizer dialog allows you to import macro libraries into your document as well as creating, deleting, and renaming libraries, modules, and dialogs.

- 1) On the *Libraries* tab, select the library container to use and then click **Import** to import macro libraries.
- 2) Navigate to the directory containing the library to import (Figure 358). Normally you can choose between `dialog.xlb` and `script.xlb`. It does not matter which of these two files you select; both will allow your macro to be imported. Macros can be stored in libraries inside LibreOffice documents. To import libraries contained in a document, select a document rather than a directory on disk.

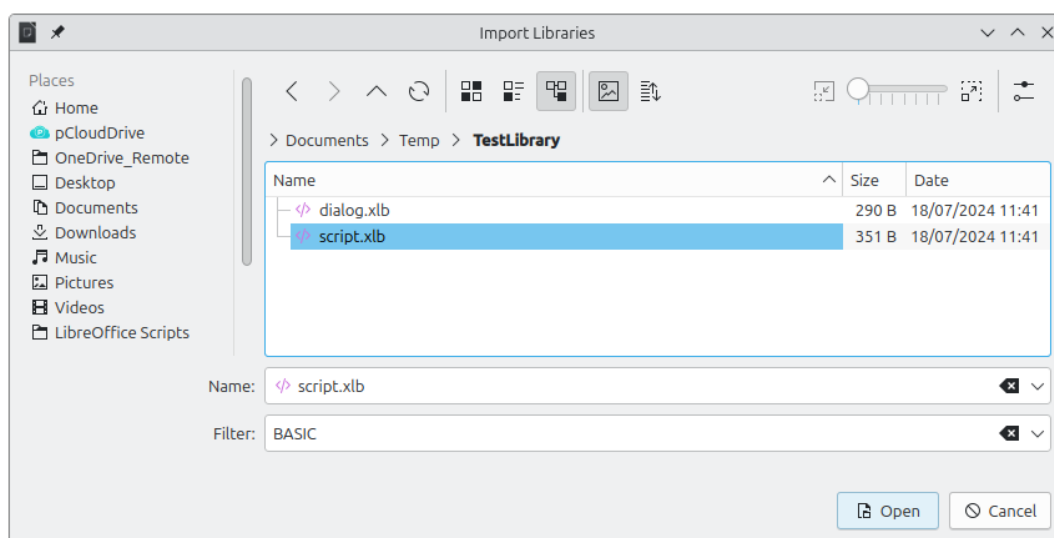

Figure 358: Navigating to a macro library

- 3) Select a file and click **Open** to continue and open the Import Libraries dialog (Figure 359).

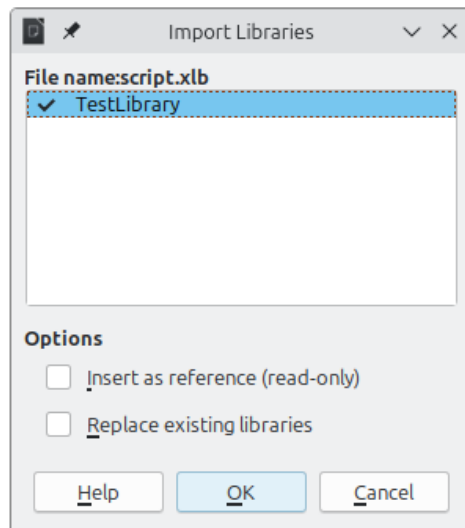

Figure 359: Choose library import options

- 4) Select the following options for importing libraries:
 - If no options are selected, the library is copied to your user macro directory. However, if the library you are importing has the same name and you are importing into the same location, it will not be copied.
 - Select **Insert as reference (read-only)** if you want to use the library as reference, but not import that library into the document. When a library is used as a reference, it remains in its current location and is fully functional, but cannot be modified in the Basic IDE.
 - Select **Replace existing libraries** if the library you want to import has the same name and you want to replace the existing library.
- 5) Click **OK** to import the macro library you selected.

Note

You cannot export/import the library named *Standard*.

Tip

On Linux, LibreOffice-specific files are stored in the user's home directory inside the `.config` folder. Directories and files with names beginning with a dot may be hidden and not shown in a normal file selection dialog. When using LibreOffice dialogs, rather than the operating system's specific dialogs, type the name of the desired directory in the *Name* field.

Downloading macros to import

You can find macros created by the LibreOffice community in the internet. Some macros are contained in documents, some as regular files that you need to import, and others are published as text and must be copied and pasted into the Basic IDE. See “Adding a macro” on page 465 on how to add macros to your macro library and “Viewing and editing macros” on page 470 on how to edit macros using the Basic IDE.

Some macros are available as free downloads on the Internet (see Table 16).

Table 16. Places to find macro examples

Location	Description
https://www.pitonyak.org/oo.php	Reference materials regarding macros.
https://www.pitonyak.org/database/	Reference materials regarding database macros.
https://wiki.documentfoundation.org/Macros	Lots of links to macros.
https://forum.openoffice.org/en/forum/	Forums, with many examples and help.

How to run a macro

You can run a macro with **Tools > Macros > Run**, but this will not be efficient when you use macros frequently. Fortunately LibreOffice has many other ways to run your macros.

While you can assign a shortcut to macros, as seen in “Running a macro” on page 469, you can also link macros to a toolbar icon, menu item, event, or a button embedded in a document. When choosing a method, it is also good to ask questions such as:

- Should the macro be available for only one document or globally for all documents?
- Is the macro for a specific document type, such as a Calc document?
- How frequently will the macro be used?

The answers will determine where to store the macro and how to make it available. For example, you will probably not add a rarely used macro to a toolbar. To help determine your choices, see Table 17.

Table 17. Where to store a macro

Where to place the macro	For all LibreOffice applications	For a specific LO application	For a single document
Toolbar	No	Yes	Yes
Menu	No	Yes	Yes
Shortcut	Yes	Yes	No
Event	Yes	No	Yes

Toolbars, menu items, and keyboard shortcuts

To add a menu item, keyboard shortcut, or toolbar icon that calls a macro, use the *Customize* dialog, which allows you to configure menus, keyboard shortcuts, toolbars, and events. To open this dialog, go to **Tools > Customize**. Use of the *Menus*, *Toolbars*, *Context Menus*, and *Keyboard* tabs are covered in Chapter 13, Customizing LibreOffice.

Events

Whenever LibreOffice detects a user action, we call it an event. For example, opening a document, changing status of modified, or moving the mouse cursor are all events. LibreOffice allows events to trigger the execution of a macro; the macro is then called an event handler. Full coverage of event handlers is well beyond the scope of this chapter, but a little knowledge can accomplish much.

Caution

Be careful when you configure an event handler. For example, if you write an event handler that is called every time that a document is modified but make a mistake so the event is not properly handled, problems can occur. One possible result is that your event handler will force you to kill LibreOffice.

- 1) Go to **Tools > Customize** to open the *Customize* dialog and select the *Events* tab (Figure 360). The events in the *Customize* dialog are related to the entire application and specific documents.
- 2) In the *Save In* drop-down, select **LibreOffice**, or a specific document from the menu to save your event.
- 3) A common use is to assign the *Open Document* event to call a specific macro. The macro then performs certain setup tasks for the document. Select the desired event and click **Macro** to open the *Macro Selector* dialog (similar to Figure 351 on page 470 but with different action buttons).
- 4) Select the desired macro and click **OK** to assign the macro to the event. The *Events* tab will show that the event has been assigned to a macro.

Many objects in a document can be set to call macros when events occur. The most common use is to add a control, such as a button, into a document. Even double-clicking on a graphic opens a dialog with a *Macros* tab that allows you to assign a macro to an event.

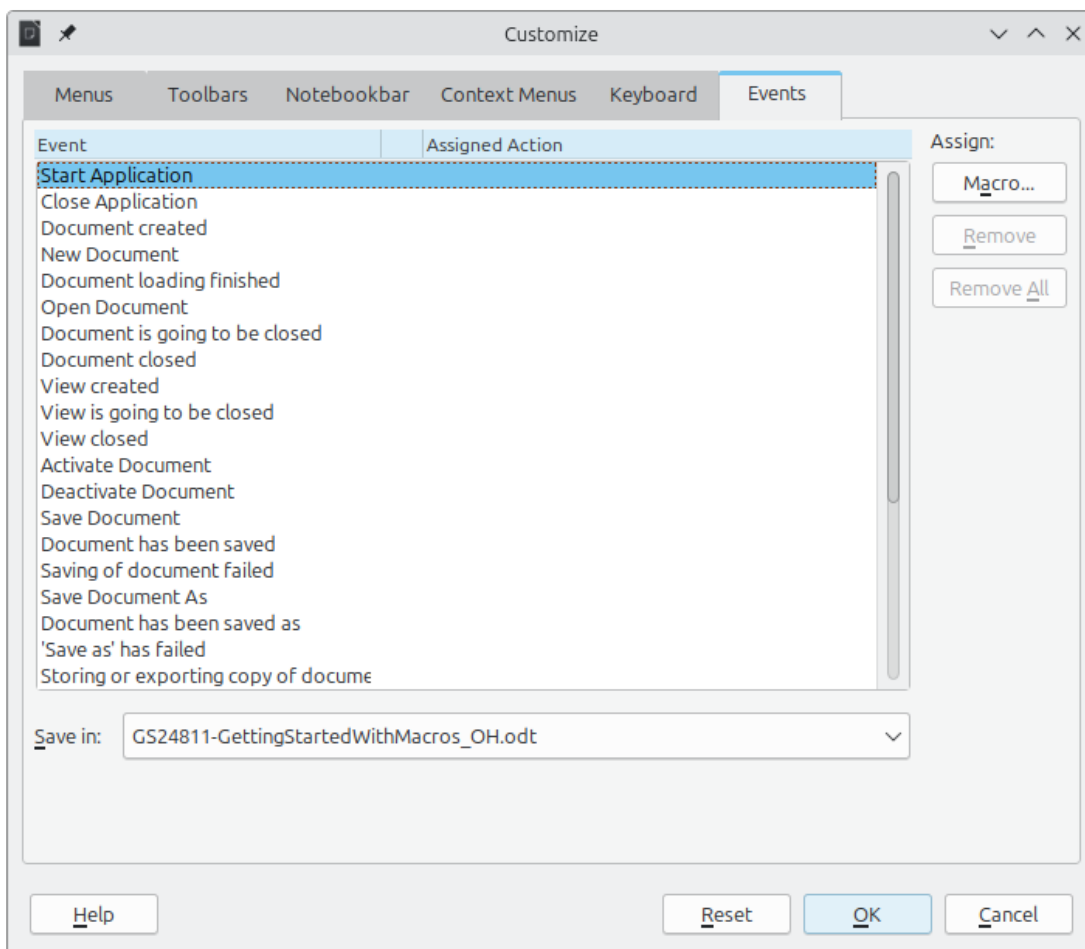

Figure 360: Events tab in Customize dialog

Using extensions

An extension is code that can be installed into LibreOffice to add new functionality. Extensions can be written in almost any programming language and may be simple or sophisticated. Extensions can be grouped into types, for example:

- Calc add-ins, which provide new functionality for Calc, including new functions that act like normal built-in functions.
- New components and functionality, which normally include some level of User Interface (UI) integration such as new menus or toolbars.
- Chart add-ins with new chart types.
- Linguistic components such as spelling checkers.
- Document templates and images.

Although individual extensions can be found in several places, there is currently an extension repository at: <https://extensions.libreoffice.org/> and some documentation at <https://libreplanet.org/wiki/Group:OpenOfficeExtensions/List>.

For more about obtaining and installing extensions, see Chapter 13, Customizing LibreOffice.

Writing macros without the recorder

The examples covered so far in this chapter were created using the macro recorder and the dispatcher, but you can also write macros in code which directly access the objects that comprise LibreOffice. In other words, you can create a macro that directly manipulates a document using more advanced programming logic.

Directly manipulating LibreOffice internal objects is an advanced topic that is beyond the scope of this chapter. A simple example, however, demonstrates how this works.

An example of a macro in code for Writer

The sample code in Listing 5 is a simple example of a macro created without the recorder that adds the string “Hello” at the end of a Writer document.

To add this macro to a library, follow the steps below:

- 1) Go to **Tools > Macros > Organize Macros > Basic**.
- 2) In *My Macros*, navigate to the library where you want the macro to be created. In this example, consider the library *TestLibrary*.
- 3) Select one of the modules already available in the library, for example *Module1*. If you want to create a new module, click **Organizer** and then add the new module.
- 4) With the module selected, click **Edit**. This will open the Basic IDE window and show the code for the macros implemented in the selected module.
- 5) Enter the code in Listing 5 into the module.

Listing 5: Append the text “Hello” at the end of to the current document

```
Sub AppendHello
    Dim oDoc
    Dim sTextService$
    Dim oCurs

    REM ThisComponent refers to the currently active document.
    oDoc = ThisComponent
```

```

REM Verify that this is a text document.
sTextService = "com.sun.star.text.TextDocument"
If NOT oDoc.supportsService(sTextService) Then
    MsgBox "This macro only works with a text document"
    Exit Sub
End If
REM Get the view cursor from the current controller.
oCurs = oDoc.currentController.getViewCursor()

REM Move the cursor to the end of the document.
oCurs.gotoEnd(False)

REM Insert text "Hello" at the end of the document.
oCurs.Text.insertString(oCurs, "Hello", False)
End Sub

```

An example of a macro in code for Calc

One powerful way to extend the functionalities of LibreOffice Calc is to write macros that automate repetitive tasks. You can use the Basic language to write macros that can do tasks ranging from simple cell handling and formatting to advanced data manipulation.

For example, Listing 6 below shows the Basic code for a macro that analyzes a range of cells to determine if all values are between 0 and 100. Values ranging from 50 to 100 should be marked in light green whereas cells with values that are greater than or equal to 0 and less than 50 should be marked in light red. If any values outside the allowed range of 0 to 100 are found, a warning message should be displayed and cells should be marked in light gray.

Listing 6: Calc macro to format ranges based on values

```

Sub FormatRangeBasedOnValue
    'Gets the current selection
    Dim oRange as Object, oCell as Object
    Set oRange = ThisComponent.getCurrentSelection()
    'Checks if the selected range is a single range
    If Not oRange.supportsService("com.sun.star.sheet.SheetCellRange") Then
        MsgBox "This macro applies only to single ranges."
        Exit Sub
    End If
    ' Number of columns and rows in selection
    Dim nCols as Long : nCols = oRange.Columns.getCount()
    Dim nRows as Long : nRows = oRange.Rows.getCount()
    Dim col as Long, row as Long
    Dim cellValue as Long
    Dim isError as Boolean : isError = False
    ' Iterate over all cells in the range
    For col = 0 To nCols - 1
        For row = 0 to nRows - 1
            Set oCell = oRange.getCellByPosition(col, row)
            cellValue = oCell.getValue()
            If cellValue >= 50 and cellValue <= 100 Then
                ' Sets background to light green
                oCell.CellBackColor = RGB(144, 238, 144)
            ElseIf cellValue >= 0 and cellValue < 50 Then
                ' Sets background to light red
                oCell.CellBackColor = RGB(255, 127, 127)
            Else
                ' Sets background to light gray
                oCell.CellBackColor = RGB(220, 220, 220)
            End If
        Next row
    Next col
End Sub

```

```

    isError = True
End If
Next row
Next col
' Displays a message indicating that there were errors
If isError Then
    MsgBox "Some cells outside the range 0 to 100 were marked in light grey"
End If
End Sub

```

To add this macro to a library, follow the steps described in “An example of a macro in code for Writer” on page 484. To run this macro, first create a new Calc sheet and add some numeric values in a range of cells. Then, select the cells and use one of the methods described in “How to run a macro” on page 482 to execute it.

Figure 361 shows an example of the macro being run on a set of cells. Because some of the cells have values that are not between 0 and 100, the message box in Figure 362 will also be displayed.

	A	B	C	D
1	44	86	14	
2	19	125	12	
3	71	-5	63	
4	1	17	92	
5	67	-2	-4	
6	34	56	8	
7	0	19	90	
8				

Figure 361: Cell values after being formatted by the macro

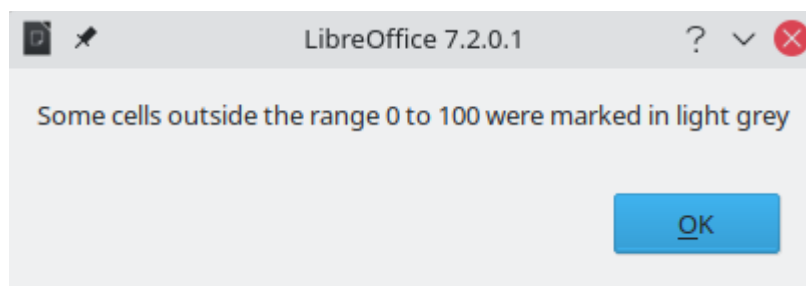

Figure 362: Message box presented if some values are not between 0 and 100

The ScriptForge library

Since macro programmers frequently need to perform tasks such as creating and opening files, accessing form controls, reading data from databases embedded in Base documents, and so forth, LibreOffice has provided them with the *ScriptForge* library. This library makes it easier to execute such commands without having to learn the required LibreOffice APIs (Application Programming Interfaces) and commands, which may be difficult for casual programmers.

ScriptForge is organized into a set of services, each of which provides methods and properties related to a specific topic. For example, the *Dialog* service provides access to dialogs available in script modules and the *Database* service allows to execute SQL commands in Base documents. The example in Listing 7 shows a macro written in Basic using the *ScriptForge* library that opens a Calc document, creates a new sheet named *NewSheet*, and inserts the string “Hello” into cell A1. The macro also saves and closes the document.

Listing 7: Macro using the ScriptForge library

```
Sub CreateSheetExample
' Loads the ScriptForge library
GlobalScope.BasicLibraries.LoadLibrary("ScriptForge")
' Instantiates the UI service
Dim ui as Object, myDoc as Object
ui = CreateScriptService("UI")
' Opens the file "myfile.ods"
Set myDoc = ui.OpenDocument("/home/user/Documents/myfile.ods")
' Inserts a new sheet named "NewSheet"
myDoc.InsertSheet("NewSheet")
' Inserts the string "Hello" into cell "A1" of the new sheet
myDoc.SetValue("NewSheet.A1", "Hello")
' Shows the sheet "NewSheet"
myDoc.Activate("NewSheet")
' Saves the document
myDoc.Save()
' Closes the document
myDoc.CloseDocument()
End Sub
```

As seen in the example, the *ScriptForge* library provides straightforward commands to execute commands, and simplify the creation of macros.



Tip

To learn more about the *ScriptForge* library, visit LibreOffice's online Help at https://help.libreoffice.org/7.4/en-US/text/sbasic/shared/03/lib_ScriptForge.html?DbPAR=BASIC. Each of the 26 supported services have been extensively documented and examples are provided for both Basic and Python programming languages.

UNO Object Inspector

LibreOffice has an extensive API that can be used by macro programmers to automate almost any aspect of its applications. However, programmers often have problems discovering object types as well as their supported services, methods, and properties.

The component model used in LibreOffice is known as Universal Network Objects or UNO. LibreOffice macros in any scripting language use a UNO runtime application programming interface (API). The XSCRIPTCONTEXT interface is provided to macro scripts in all four available languages (LibreOffice Basic, Python, JavaScript, and BeanShell) which provides some means of access to the various interfaces which they might need to perform an action on a document.

The *UNO Object Inspector* can help macro developers inspect objects, learn how to access them, and use them in macros. This feature is available in Writer, Calc, Impress, and Draw. To enable it, go to **Tools > Development Tools**. The Object Inspector will be opened at the bottom of the user interface, as shown in Figure 363.

The left portion of the *Object Inspector* consists of the *Document Object Model (DOM)* navigator, which allows the user to navigate through all the objects in the document. When an object is selected, information about the object are shown in the right portion of the Object Inspector window:

- The names of all implemented interfaces.
- The names of all services supported by the object.

- The names and types of all properties available in the object.
- The names, arguments and return types of all methods that can be called by the object.

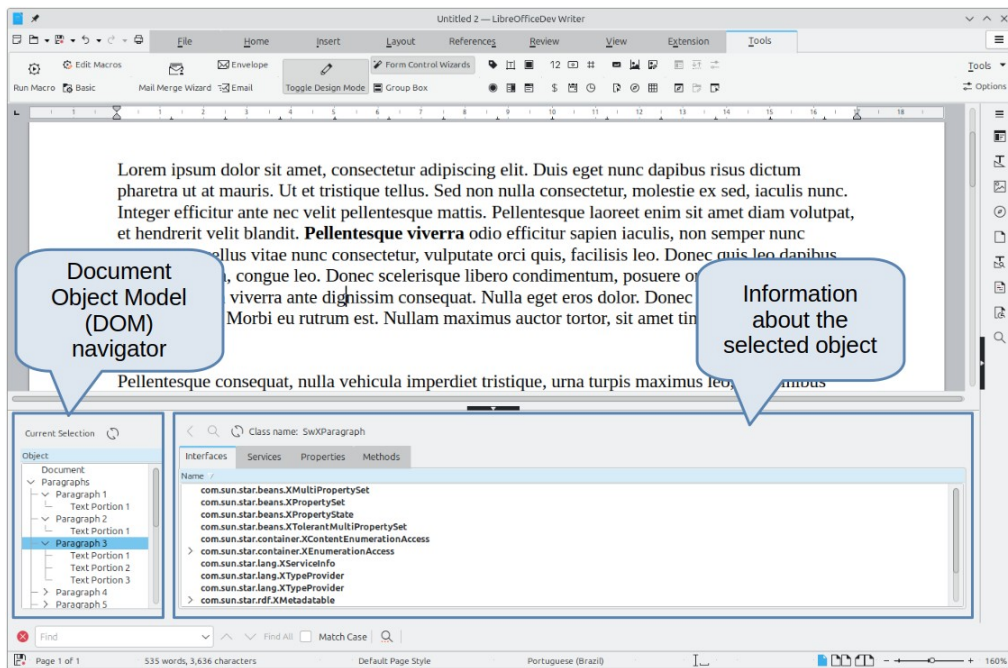

Figure 363: UNO Object Inspector opened in a Writer document

Instead of inspecting objects using the *DOM navigator*, it is possible to directly inspect the currently selected object in the document by toggling the **Current Selection** button.

For example, suppose you want to change the background color of the text selected in a Writer document. You can select a portion of text, open the Object Inspector, toggle the Current Selection button, then inspect the object properties in search of a property that matches the desired effect. Figure 364 shows the *CharBackColor* property selected, which is the property used to set text background color.

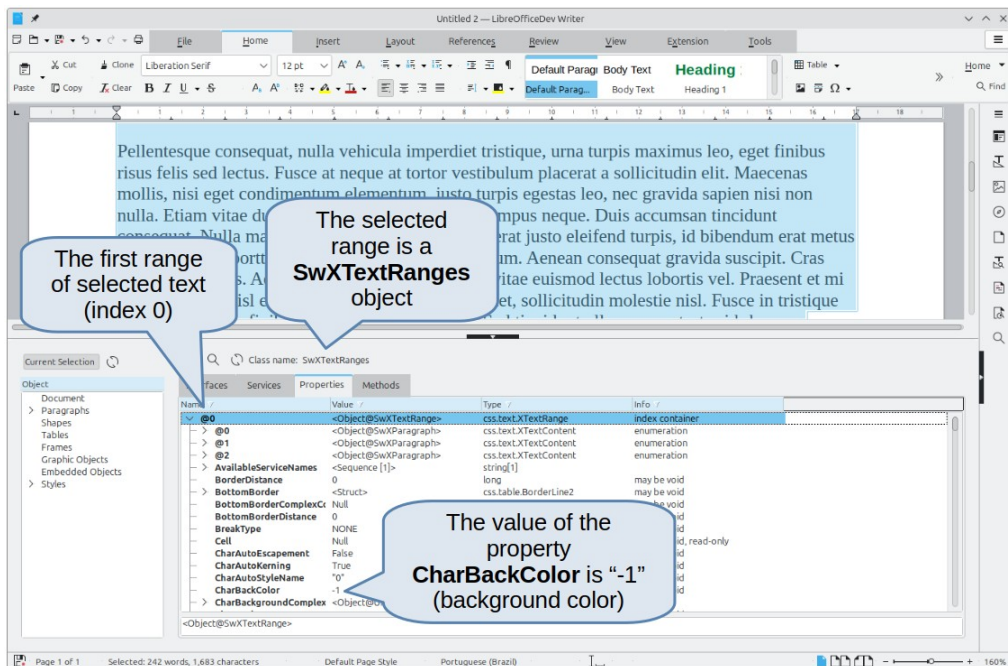

Figure 364: Using the Object Inspector to find a property

Now it is possible to write a macro using this property to change the background color of the selected text. Listing 8 shows the code for this macro.

Listing 8: Macro that changes the background color of a text range

```
Sub ChangeTextBGColor
  Dim oSel as Object
  Set oSel = ThisComponent.getCurrentSelection()
  oSel(0).CharBackColor = RGB(255, 127, 127)
End Sub
```

Note that in Writer it is possible to have multiple ranges selected at once, hence `oSel(0)` accesses the first range of text.

Overview of Python, BeanShell, and JavaScript macros

Many programmers may not be familiar with LibreOffice Basic, so LibreOffice supports macros written in three other familiar languages: Python, BeanShell, and JavaScript.

Macros are organized in the same way for all four scripting languages. The *LibreOffice Macros* container holds all the macros that are supplied in the LibreOffice installation. The *My Macros* library container holds those macros that you made available to any of your LibreOffice documents. Each document can also contain your macros that are not available to any other document.

When you use the recording facility, the macros are created in LibreOffice Basic. To use the other available scripting languages, you must write the code yourself.

When you select to run a macro using **Tools > Macros > Run Macro**, LibreOffice displays the *Macro Selector* dialog. This dialog enables selection and running of any available macro, coded in any of the available languages (Figure 365).

When you edit a macro using **Tools > Macros > Edit Macros**, LibreOffice displays the LibreOffice Basic IDE. This dialog enables selection and editing of any available LibreOffice Basic macro, but not macros in other languages.

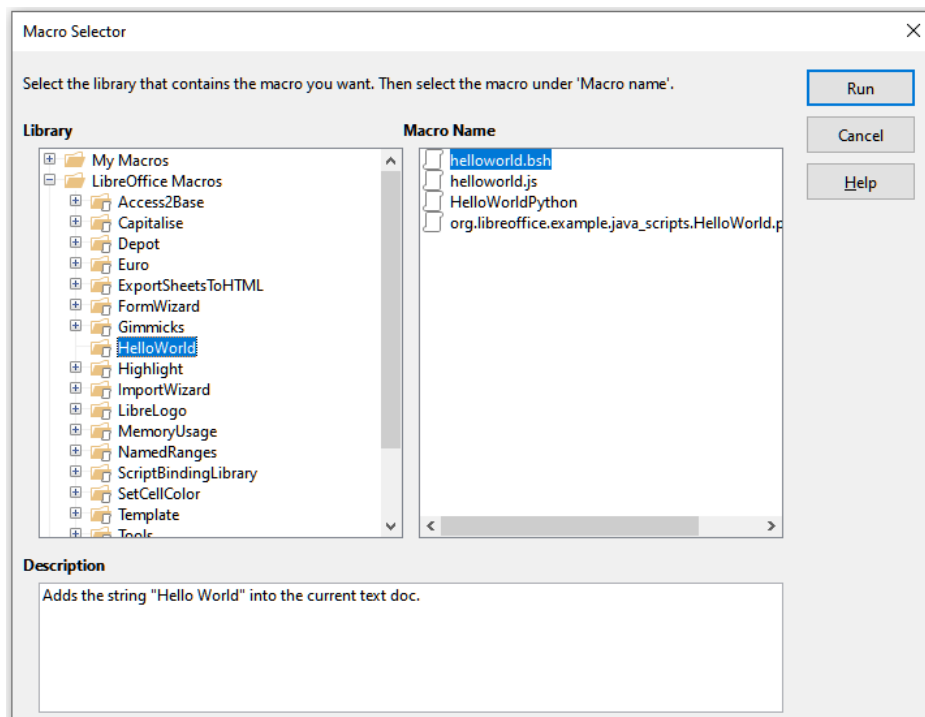

Figure 365: Macro Selector dialog

Tip

If you want to learn more about the LibreOffice API as well as UNO objects, refer to the official API documentation at <https://api.libreoffice.org/>

Python macros

Python is a high-level, general-purpose programming language that was first released in 1991.

When you select **Tools > Macros > Organize Macros > Python**, LibreOffice displays the Python Macros dialog (Figure 366). Facilities to edit and debug Python scripts are not currently integrated into the standard LibreOffice user interface. However, you can use any Python editor to create scripts and then copy these files into the Scripts folder in your home directory. For more information, refer to “Where are macros stored?” on page 479.

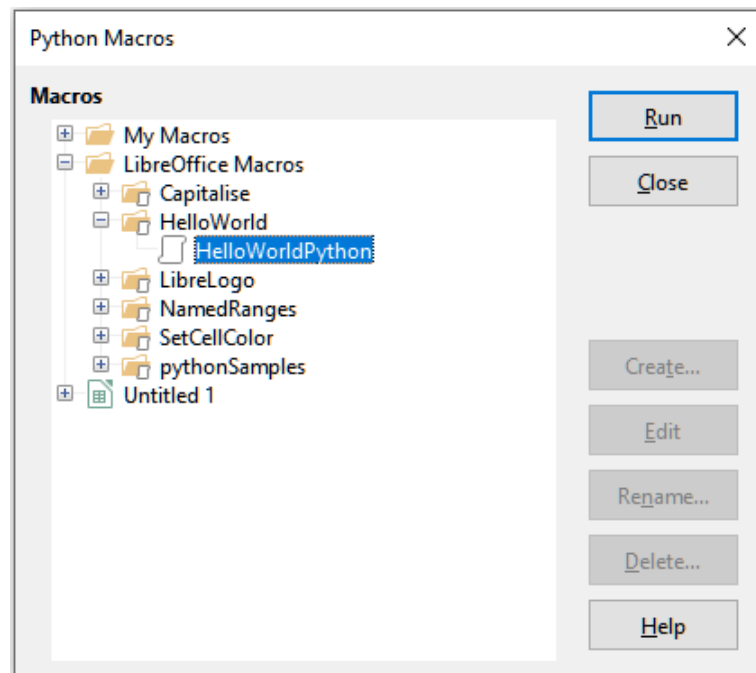

Figure 366: Python Macros dialog

Listing 9 presents an example of a Python macro that writes the text “Hello World from Python” into cell A1 of the first sheet in a Calc spreadsheet.

Listing 9: Sample Python macro

```
import uno

def HelloWorld():
    doc = XSCRIPTCONTEXT.getDocument()
    cell = doc.Sheets[0]['A1']
    cell.setString('Hello World from Python')
    return
```

Tip

The Alternative Python Script Organizer (APSO) extension makes it easier to edit and organize Python scripts, especially when they are embedded in a document. Using APSO you can configure your preferred source code editor, start the integrated Python shell and debug Python scripts. Visit <https://gitlab.com/jmzambon/apso> to download APSO and learn more about how to use it.

Tip

To learn more about Python scripting in LibreOffice, you can refer to the Wiki “Macros/Python Basics”, where you will find in-depth explanations and examples on how to get started with Python scripting. To learn more, visit https://wiki.documentfoundation.org/Macros/Python_Basics.

BeanShell macros

BeanShell is a Java-like scripting language that was first released in 1999.

When you select **Tools > Macros > Organize Macros > BeanShell**, LibreOffice displays the BeanShell Macros dialog (Figure 367).

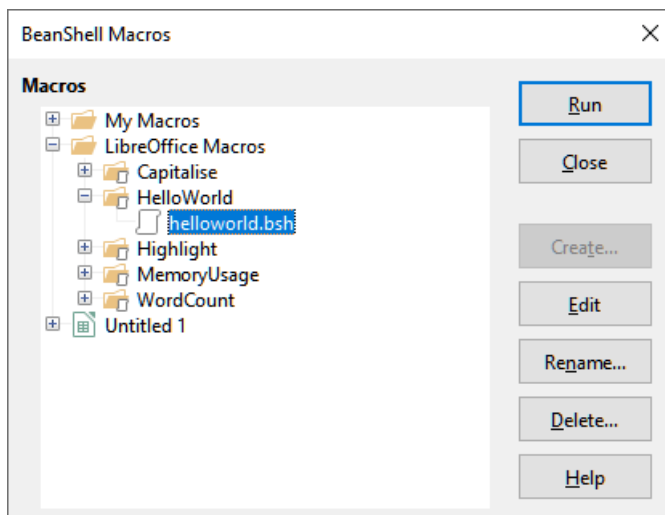

Figure 367: BeanShell Macros dialog

Click the **Edit** button on the BeanShell Macros dialog to access the BeanShell Debug Window (Figure 368).

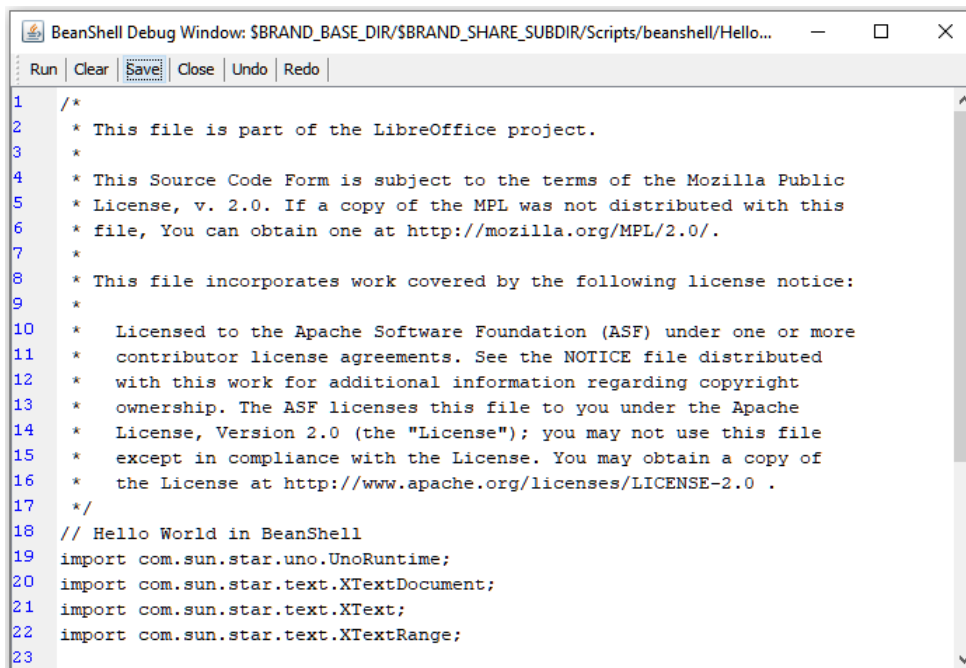

Figure 368: BeanShell Debug Window

Listing 10 is an example of a BeanShell macro that inserts the text “Hello World from BeanShell” in cell A1 of the active Calc spreadsheet.

Listing 10: Sample BeanShell macro

```
import com.sun.star.uno.UnoRuntime;
import com.sun.star.sheet.XspreadsheetView;
import com.sun.star.text.XText;
model = XSCRIPTCONTEXT.getDocument();

controller = model.getCurrentController();

view = UnoRuntime.queryInterface(XspreadsheetView.class, controller);

sheet = view.getActiveSheet();

cell = sheet.getCellByPosition(0, 0);

cellText = UnoRuntime.queryInterface(XText.class, cell);

textCursor = cellText.createTextCursor();

cellText.insertString(textCursor, "Hello World from BeanShell", true);

return 0;
```

JavaScript macros

JavaScript is a high-level scripting language that was first released in 1995.

When you select **Tools > Macros > Organize Macros > JavaScript**, LibreOffice displays the JavaScript Macros dialog (Figure 369).

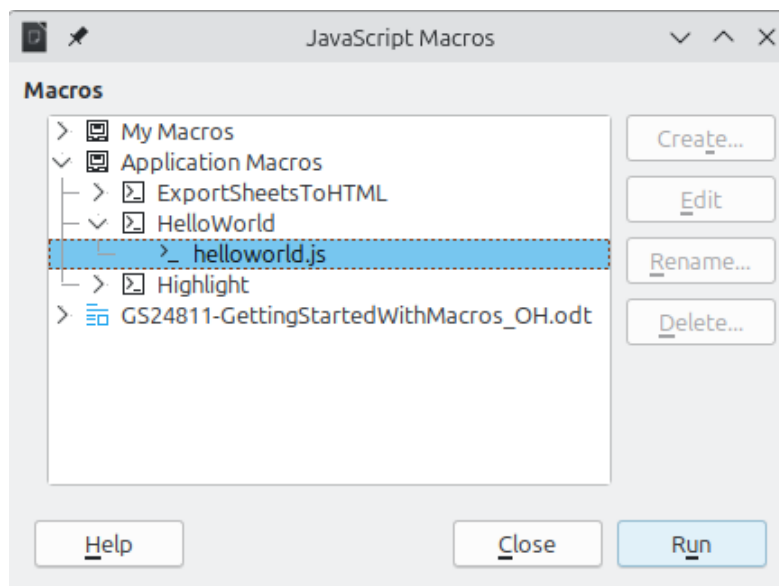

Figure 369: JavaScript Macros dialog

Listing 11 is an example of a JavaScript macro that inserts the text “Hello World from JavaScript” in cell A1 of the first sheet in a Calc spreadsheet.

Listing 11: Sample JavaScript macro

```
importClass(Packages.com.sun.star.uno.UnoRuntime);
importClass(Packages.com.sun.star.sheet.XspreadsheetDocument);
importClass(Packages.com.sun.star.container.XindexAccess);
```

```

importClass(Packages.com.sun.star.table.XcellRange);
importClass(Packages.com.sun.star.table.Xcell);

documentRef = XSCRIPTCONTEXT.getDocument();
spreadsheetInterface = UnoRuntime.queryInterface(XSpreadsheetDocument, documentRef);
allSheets = UnoRuntime.queryInterface(XIndexAccess,
spreadsheetInterface.getSheets());
theSheet = allSheets.getByIndex(0);

Cells = UnoRuntime.queryInterface(XCellRange, theSheet);
cellA1 = Cells.getCellByPosition(0,0);
theCell = UnoRuntime.queryInterface(XCell, cellA1);
theCell.setFormula("Hello World from JavaScript");

```

Changing the color scheme of the Basic IDE

To change the color scheme used by the **Basic IDE** code editor, do the following steps:

- 1) From within the **Basic IDE** go to **View > Color scheme** to open the **Color Scheme** dialog
- 2) By default the option **Use Application Colors** is selected, which makes the Basic IDE use the colors defined in the **Application Colors** dialog (accessible via **Tools > Options > Application Colors**)
- 3) To use a different color scheme, click **Choose Color Scheme** and select one of the available entries in the list box
- 4) Click **OK** to apply the selected color scheme

Figure 370 shows the code editor after selecting the *Solarized Light* color scheme. Notice that the color scheme only changes the colors used by the code editor.

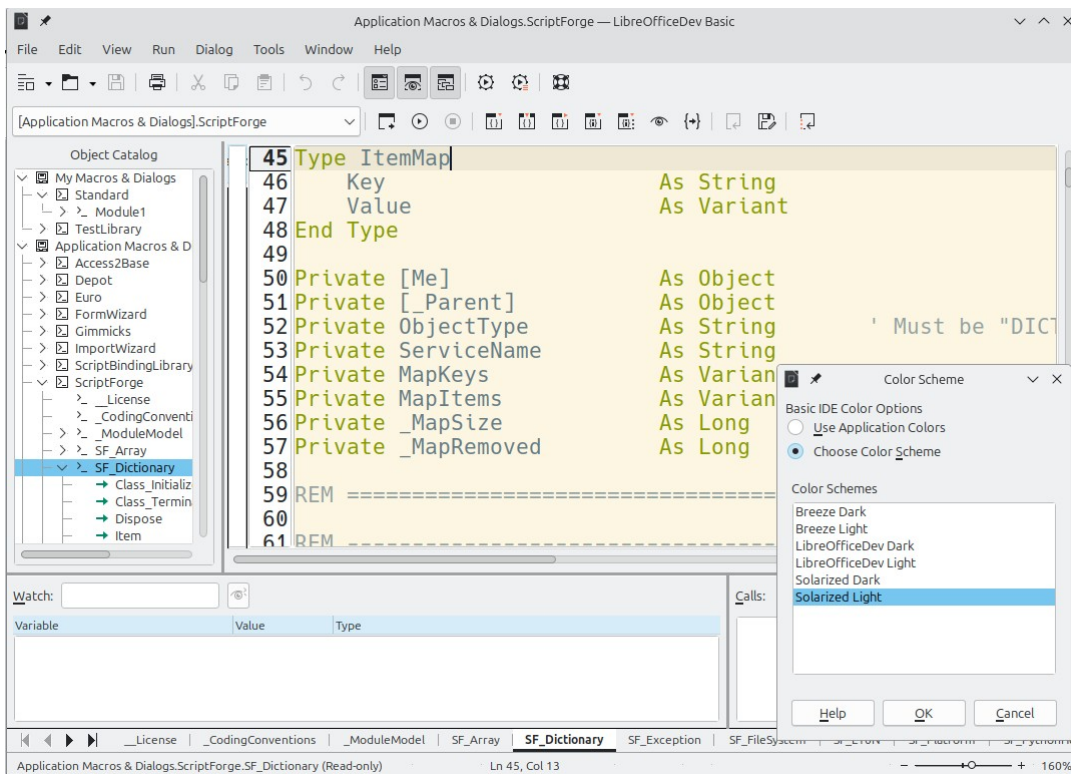

Figure 370: Basic IDE after applying the Solarized Light color scheme



Tip

Additional color schemes can be added by extensions. Visit LibreOffice's Extensions website to search for additional color schemes for your Basic IDE.

Finding more information

Numerous resources are available that provide help with writing macros. Use **Help > LibreOffice Help**, or press the *F1* key, to open the LibreOffice help pages. The upper left corner of the LibreOffice help system contains a drop-down list that determines which help set is displayed. To view the help for Basic, choose **Basic** from this list.

Included material

Many excellent macros are included with LibreOffice. Use **Tools > Macros > Organize Macros > Basic** to open the LibreOffice Basic Macros dialog. Expand the *Tools* library in the *LibreOffice* library container. Inspect the *Debug* module; some good examples include *WritedbglInfo* (document) and *printdbgInfo* (sheet).

Online resources

The following links and references contain information regarding macro programming:

<https://wiki.documentfoundation.org/Macros>

<https://ask.libreoffice.org/> (a Q&A site where volunteers answer questions related to LibreOffice)

https://wiki.documentfoundation.org/Documentation/Other_Documentation_and_Resources (look in Programmers section for BASIC Programmers' Guide and Developers' Guide; the latter contains a detailed explanation)

<http://forum.openoffice.org/en/forum/> (Apache OpenOffice community forum; volunteers answer questions about LibreOffice as well)

Printed and ebook materials

Andrew Pitonyak published a free online book *OpenOffice.org Macros Explained*, which is a great reference for learning the Basic language used in both LibreOffice and OpenOffice. You can download the PDF version at https://www.pitonyak.org/OOME_3_0.pdf.

Dr. Mark Alexander Bain published the book *Learn OpenOffice.org Spreadsheet Macro Programming*. See <https://www.packtpub.com/openoffice-ooobasic-calc-automation/book>.

Roberto Benitez's *Database Programming with OpenOffice.org Base & Basic* is also a great source to learn more about macro programming.



LibreOffice
Community



Chapter 12, *Configuring LibreOffice*

Choosing options to suit the way of working

Introduction

This chapter describes some of the setup options found in **Tools > Options** (macOS **LibreOffice > Preferences**) on the Menu bar. Additional options, and more details about the options in this user guide, are covered in LibreOffice Help.

Tip

Many options are intended for power users and programmers. If understanding is difficult on what an option does, it is usually best to leave the option on its default setting unless instructions in this user guide recommend changing the setting.

LibreOffice options

This section covers some of the options and settings that apply to all the components of LibreOffice. For information on options or settings that are not discussed in this section, see the LibreOffice Help.

To open the Options LibreOffice dialog for LibreOffice (Figure 371), go to **Tools > Options** (macOS **LibreOffice > Preferences**) on the Menu bar. The list in the left-hand box of the Options LibreOffice dialog varies depending on which LibreOffice module is open. The figures in this chapter show this list in the left-hand box as it appears when a Writer document is open. Click the chevron > next to LibreOffice to select a category from the drop-down list and display the relevant page on the right-hand side of the dialog.

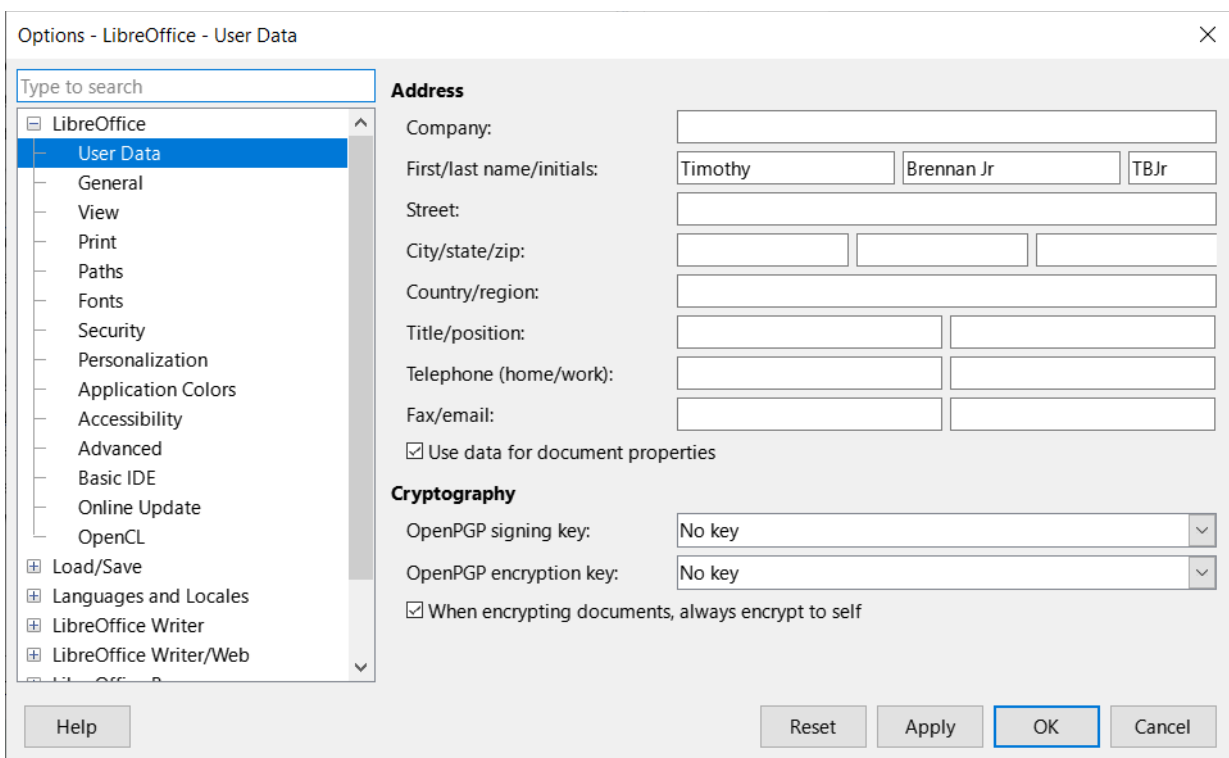

The screenshot shows the 'Options - LibreOffice - User Data' dialog box. The left sidebar contains a tree view with 'User Data' selected. The main area is divided into two sections: 'Address' and 'Cryptography'. The 'Address' section includes fields for 'Company', 'First/last name/initials' (with sub-fields for 'Timothy', 'Brennan Jr', and 'TBJr'), 'Street', 'City/state/zip' (with sub-fields), 'Country/region', 'Title/position', 'Telephone (home/work)', and 'Fax/email'. There is also a checkbox for 'Use data for document properties'. The 'Cryptography' section includes dropdown menus for 'OpenPGP signing key' and 'OpenPGP encryption key', both set to 'No key', and a checkbox for 'When encrypting documents, always encrypt to self'. At the bottom are buttons for 'Help', 'Reset', 'Apply', 'OK', and 'Cancel'.

Figure 371: Options LibreOffice dialog — User Data page

Notes

If a version of LibreOffice being used is not US English, some field labels may be different from those shown in the following figures.

The **Reset** button, located at the lower right of the Options dialog, resets the values on that page to the values that were in place when the dialog opened.

User data

On the User Data page of the Options LibreOffice dialog (Figure 371), the details of a LibreOffice user can be entered and stored. These user details are used for several things within LibreOffice such as who created or last edited a document, author of comments or changes, sender address in mailing lists, and so on.

It is necessary to make sure that the correct user information appears here. Fill in the necessary information if these details are blank, or amend and/or delete any existing information not required.

If user data is not going to be used for document's properties, deselect the option **Apply user data** in the Properties dialog for the LibreOffice file that is open. Go to **File > Properties** on the Menu bar to open the Properties dialog for a file.

In **Cryptography** on the User Data page, set the preferred public keys for OpenPGP encryption and digital signature. These keys are pre-selected in the text boxes for *OpenPGP signing key* and *OpenPGP encryption key* when a document is digitally signed or encrypted (for more information, see Chapter 10, Working with File Formats, Security, and Exporting).

General

The options available on the Options LibreOffice dialog — General page (Figure 372) are described as follows.

Help

Extended tips

When Extended tips is active, a brief description of the function of an icon, menu command, or a field on a dialog appears when the cursor is held over the item.

Warn if local help is not installed

Deselect this option to disable a warning when selecting Help, if offline help is not installed.

Show “Tip of the Day” dialog on start-up

Deselect to disable the *Tip of the Day* dialog.

Open/Save Dialogs

Use LibreOffice dialogs

Select this option to use the Open and Save dialogs supplied with LibreOffice. Deselect to use the standard Open and Save dialogs of the computer operating system. This guide uses the LibreOffice Open and Save dialogs in illustrations.

Document Status

Printing sets “document modified” status

If this option is selected, the next time the document is closed after printing, the print date is recorded in the document properties as a change. There will be prompt to save the document again, even if any other changes have not been made.

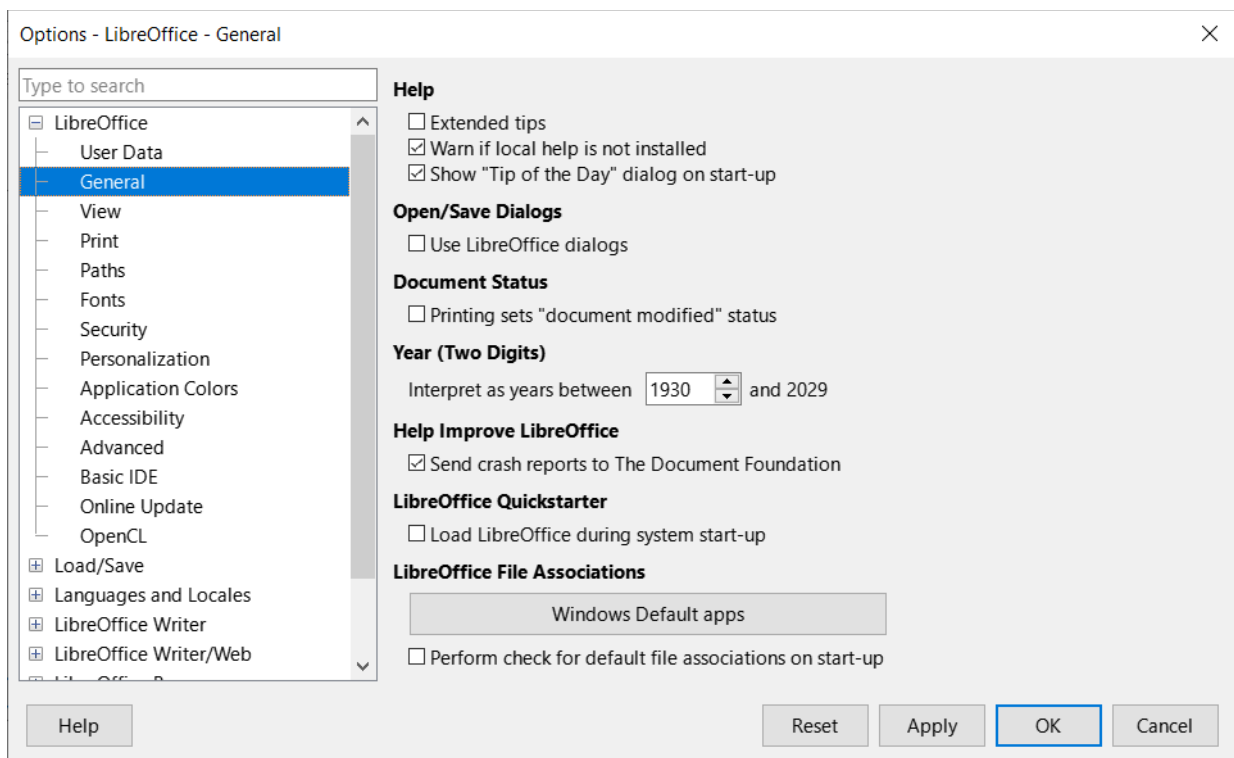

Figure 372: Options LibreOffice dialog — General page

Year (Two Digits)

Specifies how two-digit years are interpreted. For example, if the two-digit year is set to 1930, and you enter a date of 1/1/30 or later into your document, the date is interpreted as 1/1/1930 or later. An “earlier” date is interpreted as being in the following century; that is, 1/1/20 is interpreted as 1/1/2020.

Help Improve LibreOffice

Send crash reports to The Document Foundation

Linux only — send usage data to help The Document Foundation improve usability of the software. The usage data is sent anonymously and carries no document contents, only the commands used.

Send crash reports to The Document Foundation

Windows only — if selected, the Error Report Tool starts automatically when a program crash occurs. The tool gathers all necessary information that can help the program developers to improve the code. Include any additional information that may help the developers to localize the error. For more information, see the Help.

LibreOffice Quickstarter

Load LibreOffice during system start-up

Windows only — when selected, the necessary library files are loaded when the computer is started, resulting in a shorter startup time for LibreOffice components. The old menu in the system tray is no longer used.

LibreOffice File Associations

Windows Default apps button

Windows only — opens Default apps dialog in Windows.

Perform check for default file associations on start-up

Windows only — when selected, LibreOffice checks file associations on startup and displays a message if any relevant formats are not registered to be opened by default in LibreOffice.

View

The options available in the View page of the Options LibreOffice dialog (Figure Error: no se encontró el origen de la referencia) affect how the document window looks and behaves. Set these options to suit user personal preferences. Some options vary with the computer operating system.

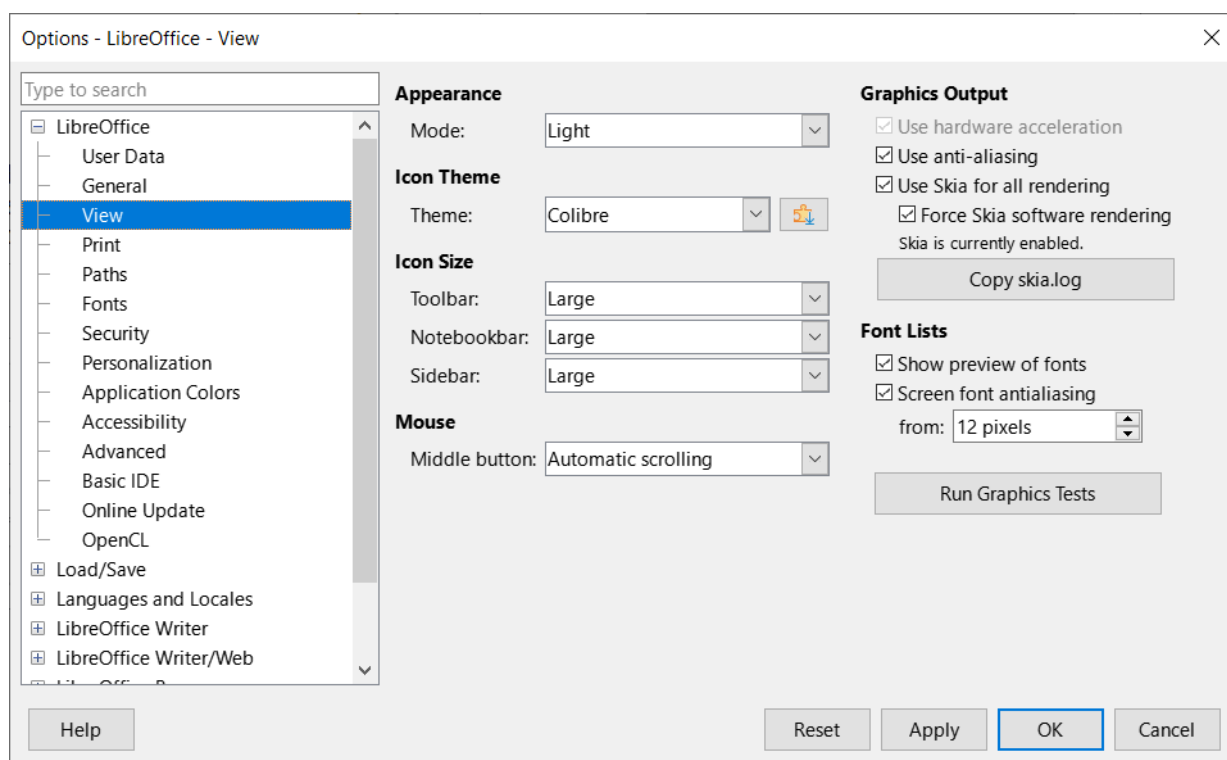

Figure 373: Options LibreOffice dialog — View page

Icon Theme

Choose the icon style for use in toolbars and dialogs. The *Automatic* option uses an icon set compatible with the operating system and choice of desktop. Several icon sets are available; for example Breeze, Breeze Dark, Colibre, Elementary, Karasa Jaga, Sifr, Sifr Dark, Sakapura, and so on. Other icon sets can be added using extensions (for more information, see Chapter 13, Customizing LibreOffice). Use the Extensions Manager to display installed extensions and locate extensions for installation into LibreOffice.

Icon size

Toolbar, Notebookbar, Sidebar

Choose the display size of toolbar icons: *Automatic, Small, Large, Extra Large* (toolbars only). The *Automatic* icon size option uses the setting for the computer operating system. The *Toolbar, Notebookbar* and *Sidebar* can have different settings.

Visibility

Menu icons, Shortcuts

Select the visibility mode (*Automatic, Hide, Show*) to hide or show icons as well as text on the Menu bar and in shortcut items.

Mouse

Positioning

Specifies if and how the cursor is positioned in newly opened dialogs (*Default button, Dialog center, No automatic positioning*).

Middle button

Defines the function of the middle mouse button (if available)



No function

Automatic scrolling — dragging while pressing the middle mouse button shifts the view.

Paste clipboard — pressing the middle mouse button inserts the contents of the *Selection clipboard* at the cursor position.

The Selection clipboard is independent of the normal clipboard used by **Edit > Copy/Cut/Paste**. The *Clipboard* and *Selection clipboard* can contain different contents at the same time as shown in Table 18.

Table 18: Clipboard and Selection clipboard functions

Function	Clipboard	Selection clipboard
Copy content	Edit > Copy or <i>Ctrl+C</i> (macOS  +C)	Select text, table, or object.
Paste content	Edit > Paste or <i>Ctrl+V</i> (macOS  +V) pastes at the cursor position.	Clicking the middle mouse button pastes at the cursor position.
Pasting into another document	No effect on the clipboard contents.	The last marked selection is the content of the Selection clipboard.

Graphics Output

Use hardware acceleration

Directly accesses hardware features of the graphical display adapter to improve the screen display.

Use anti-aliasing

Enables and disables anti-aliasing, which makes the display of most graphical objects look smoother and with fewer artifacts.



Tip

Use *Ctrl+Shift+R* (macOS +*Shift+R*) to restore or refresh the view of the current document after changing the anti-aliasing settings to see the effect.

Use Skia for all rendering

Windows and macOS only — enables and disables the use of the 3D graphics language Skia.

Force Skia software rendering

Windows and macOS only — forces the use of Skia even if the graphics device is blacklisted. A device is blacklisted when it is buggy or may render graphics with poor quality.

Font Lists

Show preview of fonts

When selected — displays the font names shown with an example of the font. When deselected, the font list shows only the font names. The fonts listed are those that are installed on the computer system. Some fonts show an additional preview of some sample text.

Screen font anti-aliasing

Select this option to smooth the screen appearance of text. Enter the smallest font size to apply anti-aliasing.

Run Graphics Tests button

Click this button to run tests and determine the efficiency of LibreOffice graphics rendering. Results are saved in a log, which is displayed in a pop-up window and can be downloaded.

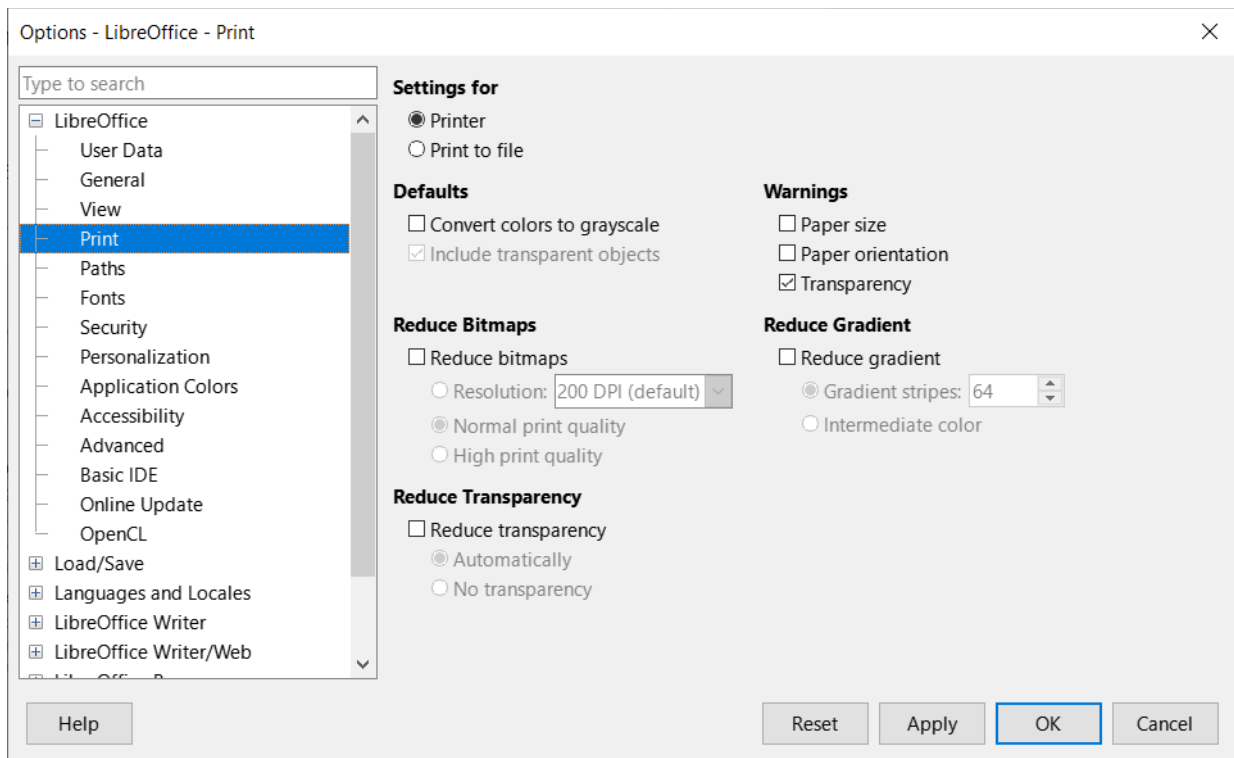

Figure 374: Options LibreOffice dialog — Print page

Print

After installing a printer on a computer, the general printing options for LibreOffice can be selected to suit the most common printing method that is going to be used in the Print page of the Options LibreOffice dialog (Figure 374).

Settings for

Specifies whether the print settings apply to direct printing or printing to a file.

Defaults

PDF as standard print job format

Linux and macOS only — select this option to change the internal print job format from Postscript format to a PDF format. Using PDF format has a number of advantages over Postscript. For more information, see the following link:

https://www.linuxfoundation.org/collaborate/workgroups/openprinting/pdf_as_standard_print_job_format.

Convert colors to grayscale

Specifies that all colors in a document are printed only as grayscale.

Include transparent objects

If selected, the reduction in print quality for bitmaps also applies to the transparent areas of objects.

Reduce bitmaps

Specifies that bitmaps are printed with reduced quality. The resolution can only be reduced and not increased.

Resolution

Specifies the maximum print quality in DPI. The resolution can only be reduced and not increased.

High print quality

High print quality corresponds to a resolution of 300dpi.

Normal print quality

Normal print quality corresponds to a resolution of 200dpi.

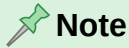

Note

Reducing the amount of data sent to the printer increases the print speed because the print files are smaller. This makes it easier for printers with a smaller memory when printing large files. However, reducing print data can result in slightly lower print quality.

Reduce transparency

If selected, transparent objects are printed like normal, non-transparent objects, depending on your selection in the following two option buttons.

Automatically

Specifies that the transparency is only printed if the transparent area covers less than a quarter of the entire page.

No transparency

When selected, a transparency does not print.



Note

Transparencies cannot be sent directly to a printer. Transparencies must be visible to be calculated as bitmaps and sent to the printer. Depending on bitmap size and the print resolution, a large amount of data may result.

Warnings

Defines which warnings appear before printing begins.

Paper size

Select this option if a certain paper size is required for printing the current document. If the paper size used in the document is not provided by the current printer, an error message opens.

Paper orientation

Select this option if a certain paper orientation is required for printing the current document. If the format used by the current document is not available from the printer, an error message opens.

Transparency

Select this option if a warning is required if transparent objects are contained in the document. When printing a document with transparencies, a dialog opens to enable selection if the transparency is to be printed.

Reduce gradient

If selected, gradients are printed with reduced quality.

Gradient stripes

Specifies the maximum number of gradient stripes for printing.

Intermediate color

Specifies that gradients are only printed in a single intermediate color.

Paths

On the Paths page in the Options LibreOffice dialog (Figure 375), the location of files associated with, or used by, LibreOffice can be changed to suit the working situation. For example, there may be a requirement to store documents by default somewhere other than in **My Documents**.

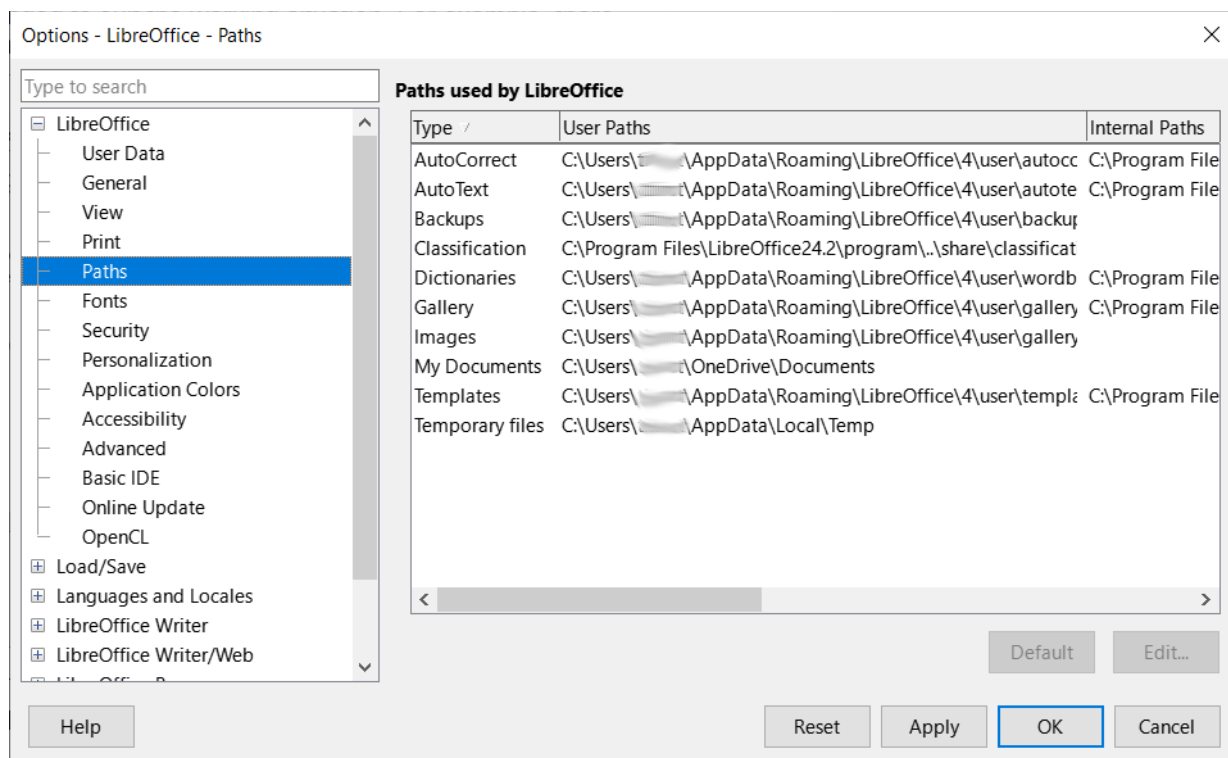

Figure 375: Options LibreOffice dialog — Paths page

To make changes, select an item in **Paths used by LibreOffice** and click on **Edit**. This opens the Select Path dialog, or Edit Paths dialog, allowing folders to added, edited, or deleted as required. Click **OK** to return to the Options dialog. Some items may have two paths listed as follows:

- **User Paths** is a user-specific folder and is normally located on a single computer.
- **Internal Paths** is a shared folder where LibreOffice is installed which is normally on a network.

Tip

Use the entries on the Paths page of the Options LibreOffice dialog to compile a list of files, such as those containing AutoText, that are required to create a back up or copy to another computer.

Fonts

The Fonts page on the Options LibreOffice dialog (Figure 376) allows the definition of any replacements for any fonts that might appear in documents. If a document is received from another source it may contain fonts that are not installed on the computer system being used. LibreOffice can substitute any fonts it cannot locate using the fonts listed on the Fonts page when required. However, this font replacement does not change the font specified in the document.

Replacement table

Lists the original font and the font that replaces it. Select *Always* to replace both the screen font and the printer font, even if the original font is installed on a computer system. Select *Screen only* to replace the screen font only and never replace the font for printing. See Table 19 below for more information

Apply replacement table

Enables the font replacement settings that have been defined.

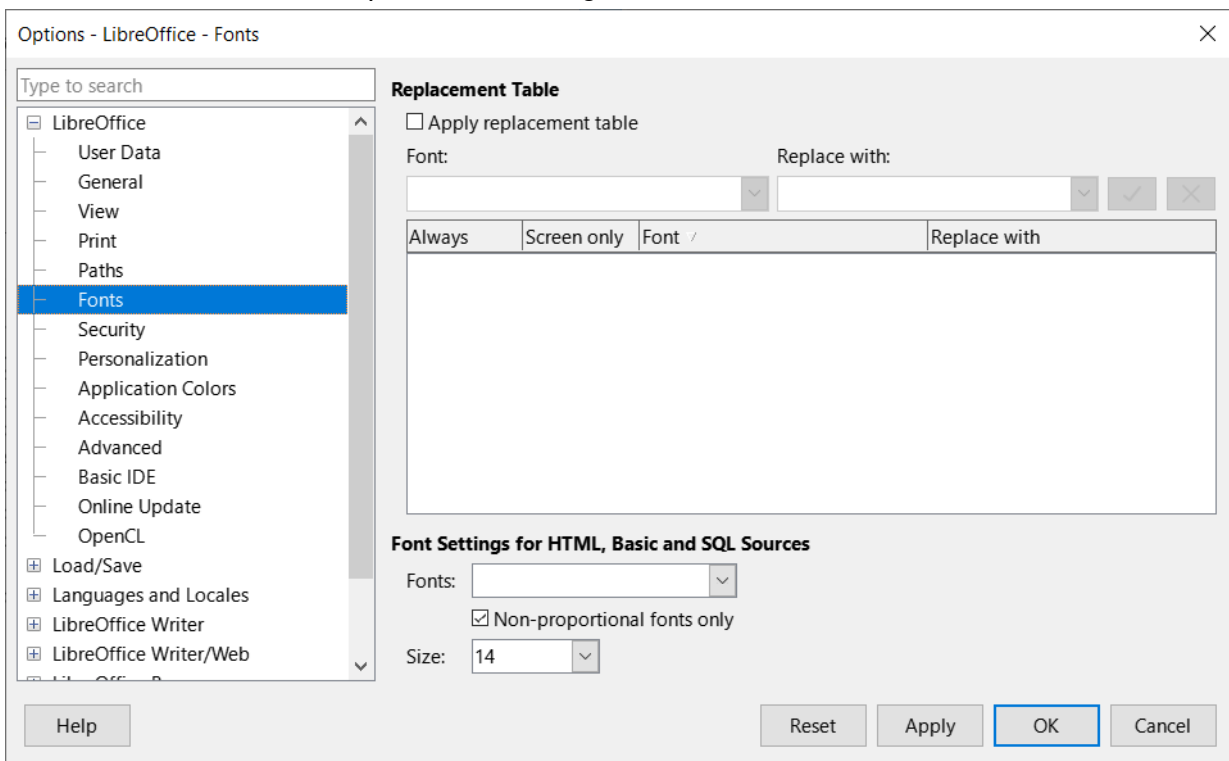

Figure 376: Options LibreOffice dialog — Fonts page

Table 19: Font replacement options

Always check box	Screen only check box	Replacement action
Checked	Blank	Font replacement on screen and when printing, whether the font is installed or not.
Checked	Checked	Font replacement only on screen, whether the font is installed or not.
Blank	Checked	Font replacement only on screen, but only if font is not available.
Blank	Blank	Font replacement on screen and when printing, but only if font is not available.

Font

Enter, or select, the name of the font that will be replaced.

Replace with

Enter or select the name of the replacement font.

Apply

Clicking on the icon applies the selected font replacement.

Delete

Clicking on the icon deletes the selected font replacement.

Font settings for HTML, Basic and SQL Sources

Select the font and font size for the display of HTML and Basic source code.

Fonts

Select the font for the display of HTML and Basic source code. Select *Automatic* to detect a suitable font automatically.

Non-proportional fonts only

Mark this check box to display only non-proportional fonts in the Fonts list box.

Size

Select a font size for the display of HTML, Basic and SQL Source code.

Security

On the Security page of the Options LibreOffice dialog (Figure 377), the security options for saving documents and for opening documents that contain macros can be selected.

Security Options and Warnings

Click on **Options** to open the Security and Warning Options dialog giving access to options for restricting what information can be changed or seen in a document. For more information on Security Options and Warnings, see LibreOffice Help:

<https://help.libreoffice.org/7.4/en-GB/text/shared/optionen/securityoptionsdialog.html>.

Security Warnings

Warns if a restricted document contains any recorded changes, versions, hidden information, or notes when saving, sending, signing, printing, or creating PDF files.

Security Options

Provides options for removing personal information, password protection, how hyperlinks are opened, and to block any links from documents that are not trusted.

Passwords for Web Connections

Enter a master password to enable easy access to websites that require a user name and password.

Persistently save web passwords for web connections

LibreOffice will securely store all passwords used to access files from web servers.

Protected by a master password

Retrieve passwords from a password list after entering the master password.

Macro Security

Click on **Macro Security** to open the Macro Security dialog where the security level for executing macros and specified trusted sources can be adjusted.

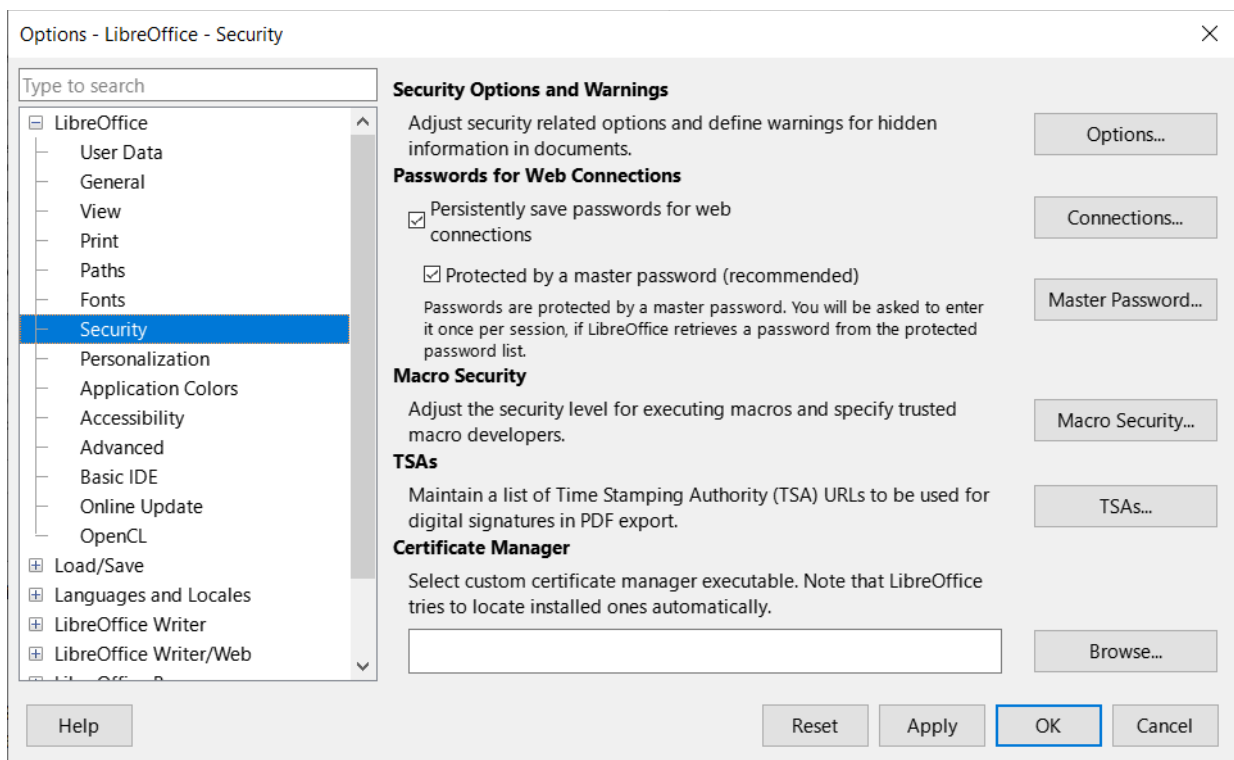

Figure 377: Options LibreOffice dialog — Security page

Certificate Path

Linux and macOS only — users can digitally sign documents using LibreOffice. A digital signature requires a personal signing certificate and most operating systems can generate a self-signed certificate. However, a personal certificate issued by an outside agency (after verifying an individual identity) has a higher degree of trust associated with it than does a self-signed certificate. LibreOffice does not provide a secure method of storing these certificates, but it can access certificates that have been saved using other programs. Click **Certificate** and select which certificate store to use. For Windows, LibreOffice uses the default Windows location for storing and retrieving certificates.

TSAs

Optionally select a Time Stamping Authority (TSA) URL for PDF documents created by LibreOffice. Recipients of PDF documents with a trusted timestamp can verify when the document was digitally or electronically signed, as well as verify that the document was not altered after the date the timestamp vouches for.

Personalization

On the Personalization page of the Options LibreOffice dialog (Figure 378), the overall appearance of LibreOffice can be changed using themes.

- Select **Default look, do not use Themes** and LibreOffice uses the default in all modules.
- Select **Preinstalled Theme**, then click on a theme thumbnail and click **Apply**. After a brief pause the appearance of LibreOffice refreshes and reflects the selected them.

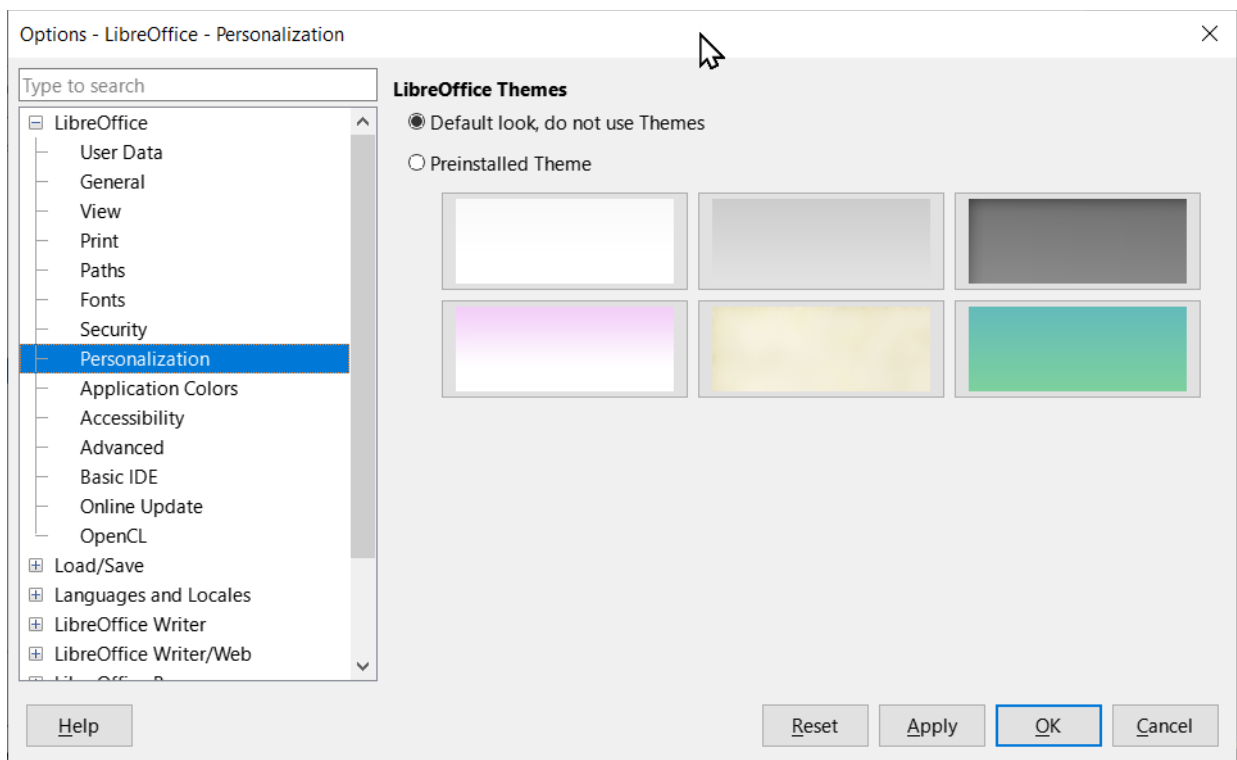

Figure 378: Options LibreOffice dialog — Personalization page

Application colors

On the Application Colors page of the Options LibreOffice dialog (Figure 379), the overall appearance of LibreOffice can be changed by setting the colors used for the LibreOffice user interface. Current settings of a color scheme being used can be saved and reloaded at a later time.

Changing colors can make using LibreOffice easier, for example when writing, editing, creating page layouts and page margins, inserting page breaks or graphics, and so on. Also, users may prefer different colors from those used as LibreOffice defaults.

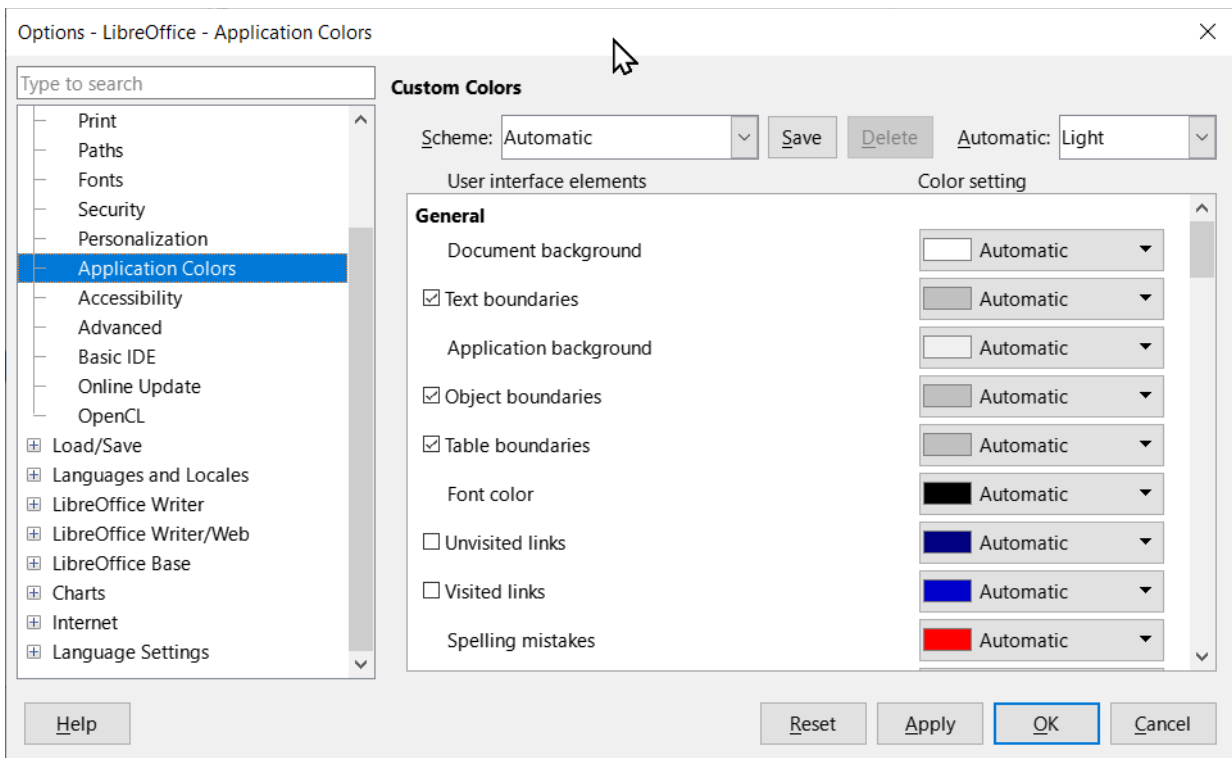

Figure 379: Options LibreOffice dialog — Application Colors page

Color Scheme

Save and delete color schemes.

Scheme

Selects the color scheme for use.

Save

Saves the current settings as a color scheme that can be reloaded later. The name of the color scheme is added to the drop-down list in the *Scheme* box.

Delete

Deletes the color scheme displayed in the *Scheme* box. The Default scheme cannot be deleted.

Custom Colors

Select the colors for the user interface elements. To apply a color to a user interface element, make sure that the element is selected. To hide a user interface element, deselect the element.

The *Automatic* color setting changes the user interface element to the preset color used by the selected color scheme.

The color settings for *Visited links* and *Unvisited links* only apply to documents created after the settings are applied.

Notes

Some user interface elements cannot be hidden.

To enhance cursor visibility, set the *Application background* to between 40% and 60% grey. If the *Application background* is set to *Automatic*, 40% grey is used.

Accessibility

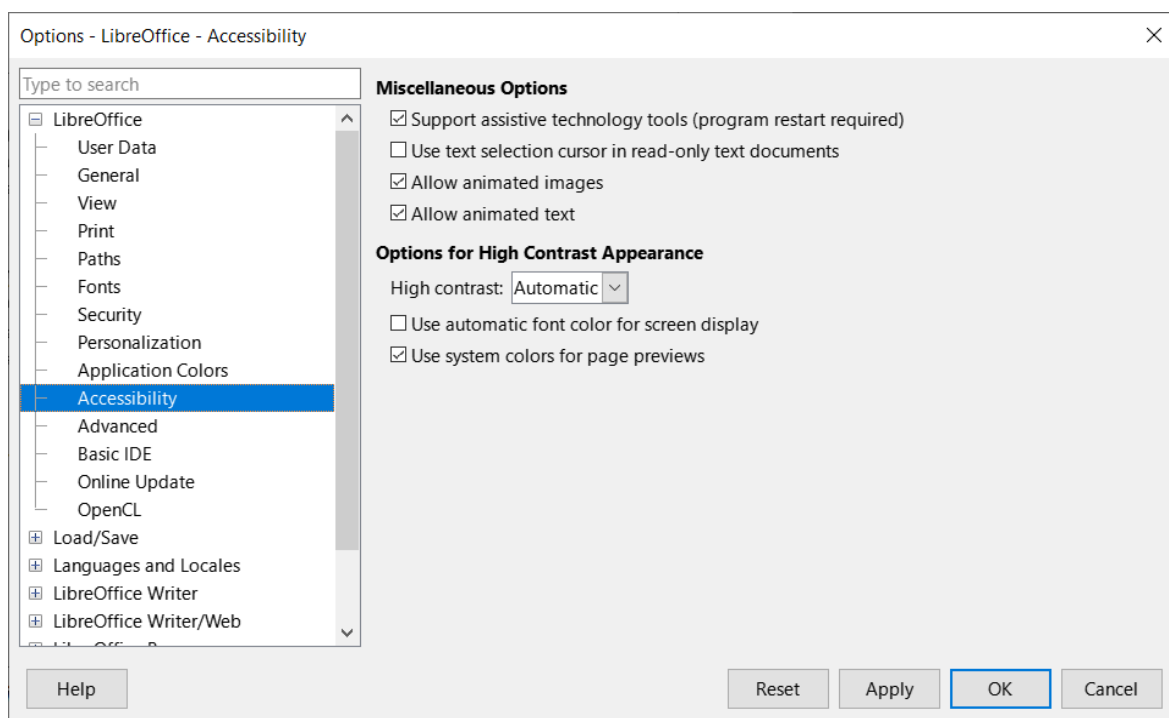

Figure 380: Options LibreOffice dialog — Accessibility page

On the Accessibility page of the Options LibreOffice dialog (Figure 380), select accessibility options including, for example, whether to allow animated graphics or text, some options for high contrast display, and a way to change the font for the LibreOffice user interface.

Miscellaneous options

Sets the accessibility options for LibreOffice.

Support assistive technology tools (program restart required)

Windows only — allows use of assistive tools, such as external screen readers, Braille devices, or speech recognition input devices. The Java Runtime Environment (JRE) must be installed on a computer before enabling assistive support.

Use text selection cursor in read-only text document

Displays cursor in read-only documents.

Allow animated images

Previews animated graphics, such as GIF images, in LibreOffice.

Allow animated text

Previews animated text, such as blinking and scrolling, in LibreOffice.

Options for High Contrast Appearance

High-contrast is an operating system setting that changes the system color scheme to improve readability. Users decide how LibreOffice uses the high-contrast settings of the operating system.

Cell borders and shadows are always shown in text color when high-contrast mode is active. The cell background color is ignored then.

High contrast

With Automatic and high contrast mode selected, it switches LibreOffice into high contrast mode when the system background color is very dark.

Use automatic font color for screen display

Displays fonts in LibreOffice using the system color settings. This option only affects the screen display.

Use system colors for page previews

Applies the high contrast settings of the operating system to page previews.

Advanced

On the Advanced page of the Options LibreOffice dialog (Figure Error: no se encontró el origen de la referencia), the support options are specified for Java applications in LibreOffice, including which Java Runtime Environment (JRE) to use. It also specifies whether to use experimental (unstable) features such as macro recording.

Notes

Windows users have a suitable Java Runtime Environment (JRE) already installed on their machines. Linux users may need to get a JRE from the distribution software repository if it not already installed. MacOS users need to install Oracle Java Development Kit (JDK), not just JRE. To get the required JDK, select the macOS option at <https://www.oracle.com/java/technologies/downloads/>.

Some options cannot be reset once edited. Either undo the changes manually, or click **Cancel** and reopen the Options LibreOffice dialog.

Make sure to install a JRE that is compatible with the LibreOffice architecture being used. That is 64-bit JRE for 64-bit LibreOffice and 32-bit JRE for 32-bit LibreOffice.

Java Options

If a JRE or JDK is installed after installing LibreOffice, or if more than one JRE is installed on a computer, use **Java Options** to select the JRE for LibreOffice to use.

If LibreOffice finds one or more JREs on a computer, it displays them in the list box. Select one of the JREs listed.

A system administrator, programmer, or other person who customizes JRE installations, can use the **Parameters** and **Class Path** dialogs to specify this information.

Use a Java runtime environment

This allows the running of Java applications in LibreOffice. When a Java application attempts to access a hard drive, a prompt opens.

Java runtime environments (JRE) already installed

Select the JRE required. On some systems, it may take at least a minute until the list is populated. On some systems, LibreOffice has to be restarted to use any changed settings. The path to the JRE is displayed beneath the list box.

The default JRE of the operating system can be overridden with one of the following alternatives:

By setting the environment variable `JAVA_HOME`.

By adding a JRE to the `$PATH` variable.

By providing the configuration file for the computer operating system in the folder `<instdir>/presets/config`.

Add

Add a path to the root folder of a JRE on a computer. The path is set in the Select Path dialog.

Parameters

Opens the Java Start Parameters dialog.

Class Path

Opens the Class Path dialog.

Optional Features

Enable experimental features (may be unstable)

Select this option to enable features that are not yet complete, or contain known bugs. The list of these features is different version by version.

Enable macro recording (may be limited)

This option enables macro recording, with some limitations. Opening a window, switching between windows, and recording in a different window from where the recording began, are not supported. Only actions relating to document contents are recordable, so changes in options or customizing menus are not supported. For more about macro recording, see Chapter 11, Getting Started with Macros.

Open Expert Configuration

Most users will have no need to use this. Select this option to open a new dialog in which the LibreOffice installation can be fine tuned. The dialog offers detailed configuration options for many aspects of the LibreOffice appearance and performance. Double-click on a listed preference to enter a value to configure the preference.



Note

The Expert Configuration dialog lets a user access, edit, and save configuration preferences that can make the user profile of LibreOffice unstable, inconsistent, or even unusable. If there is no knowledge what an option does, it is best to leave the option at its default setting.

Online Update

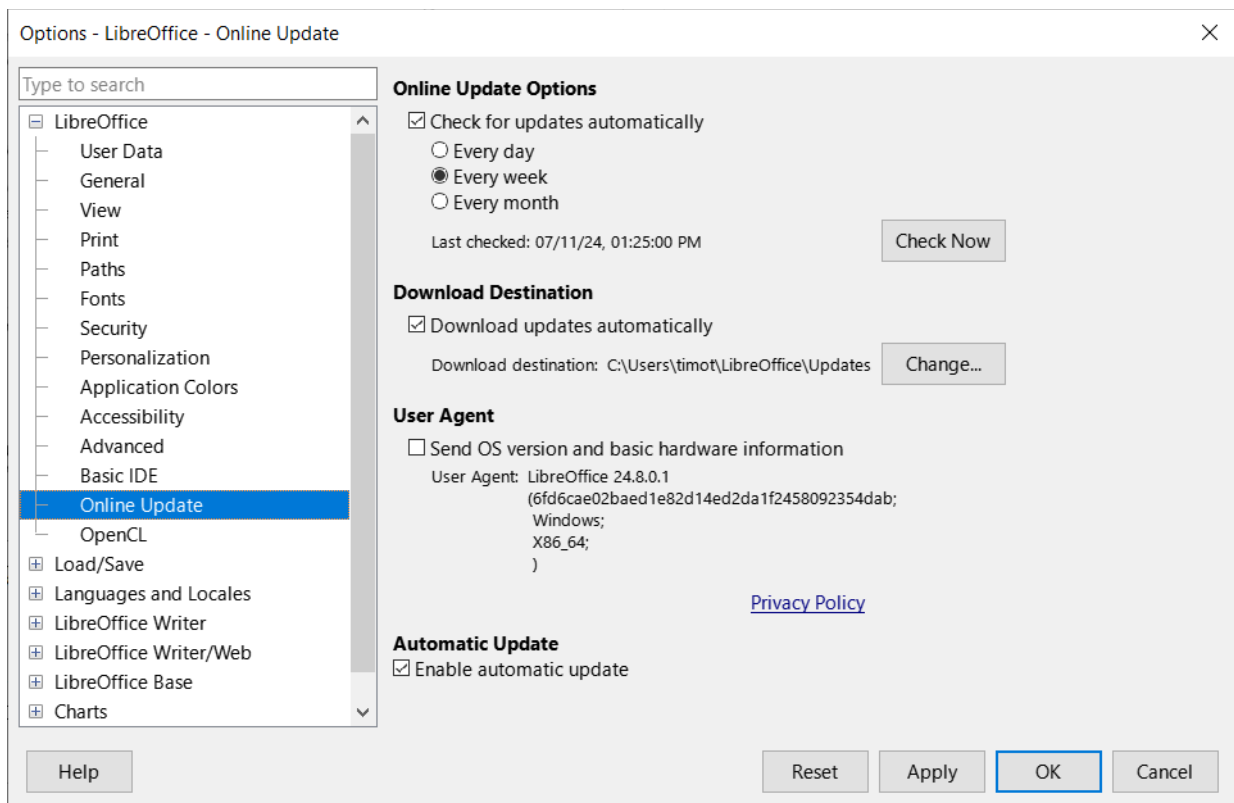

Figure 381: Options LibreOffice dialog — Online Update page

On the Online Update page of the Options LibreOffice dialog (Figure 381), options are specified for the automatic notification and downloading of online updates to LibreOffice.

Online Update Options

Check for updates automatically

Mark to check for online updates periodically, then select the time interval for how often LibreOffice will check for online updates. LibreOffice can check *Every day*, *Every week*, or *Every month*, as soon as a working Internet connection is detected. Also, click on **Check Now** to immediately check for an update.

Connecting to the Internet by a proxy server, set the proxy in **Tools > Options > Internet > Proxy** (macOS **LibreOffice > Preferences > Internet > Proxy**).

Download Destination

Displays the selected folder to store the downloaded files.

Download updates automatically

Enable the automatic download of updates to the specified folder.

Change

Click to select the destination folder for downloaded files.

User Agent

Select this option to send information about the LibreOffice version, operating system and basic hardware. This information is used to optimize the download.

OpenCL

OpenCL™ is an open, royalty-free standard for cross-platform, parallel programming of modern processors found in personal computers, servers and hand-held/embedded devices. OpenCL (Open Computing Language) greatly improves speed and responsiveness for a wide spectrum of applications in numerous market categories from gaming and entertainment to scientific and medical software. For more information on OpenCL, visit <https://www.khronos.org/opencv/>.

With OpenCL enabled, LibreOffice can benefit from the very fast numerical calculations performed in the GPU, which is especially useful in very large spreadsheets with extensive calculations. The computer video card driver must have support for OpenCL to use this feature.

Loading and saving documents

Options for loading and saving documents can be selected in the Options Load/Save dialog to suit working requirements on a computer system. If the Options Load/Save dialog is not already open, go to **Tools > Options > Load/Save** (macOS **LibreOffice > Preferences > Load/Save**) on the Menu bar.

General

On the General page of the Options Load/Save dialog (Figure 382), the default settings for saving documents and default file formats can be selected.

Load

Load user-specific settings with the document

A LibreOffice document contains settings that are read from a computer system. When saving a document, these settings are saved with it. Select this option so that when a document loads, it ignores the stored settings in favor of the settings on the computer. If this option is not selected, the following user-specific settings still apply:

Settings in **File > Print > Options**.

Spacing options for paragraphs before text tables.

Information about automatic updating for links, field functions, and charts.
Information about working with Asian character formats.

The data source linked to the document and its view are always loaded with the document, whether or not this option is selected.

Load printer settings with the document

If enabled, the printer settings are loaded with the document. This can cause a document to be printed on a distant printer (perhaps in an office setting). To prevent this happening, manually change the printer in the Print dialog. If disabled, the default printer will be used to print the document. The current printer settings are stored with the document whether or not this option is selected.

Save

Save AutoRecovery information every __ minutes

Select AutoRecovery and the time period for how often the information used by the AutoRecovery process is saved. AutoRecovery saves information required to restore all open documents if LibreOffice crashes. Setting this option makes recovering a document after a system crash easier.

In addition to the AutoRecovery information option, LibreOffice can also automatically save the document in the given time interval.

Edit document properties before saving

Specifies that the Properties dialog opens when a file is saved for the first time and every time **Save As** is selected.

Always create backup copy

Saves the previous version of a document as a backup copy whenever a document is saved. Every time LibreOffice creates a backup copy, the previous backup copy is replaced. A backup copy uses the extension **BAK**.

To change the location of the backup copy, go to **Tools > Options > LibreOffice > Paths** (macOS **LibreOffice > Preferences > LibreOffice > Paths**) and then enter a new path for the backup file.

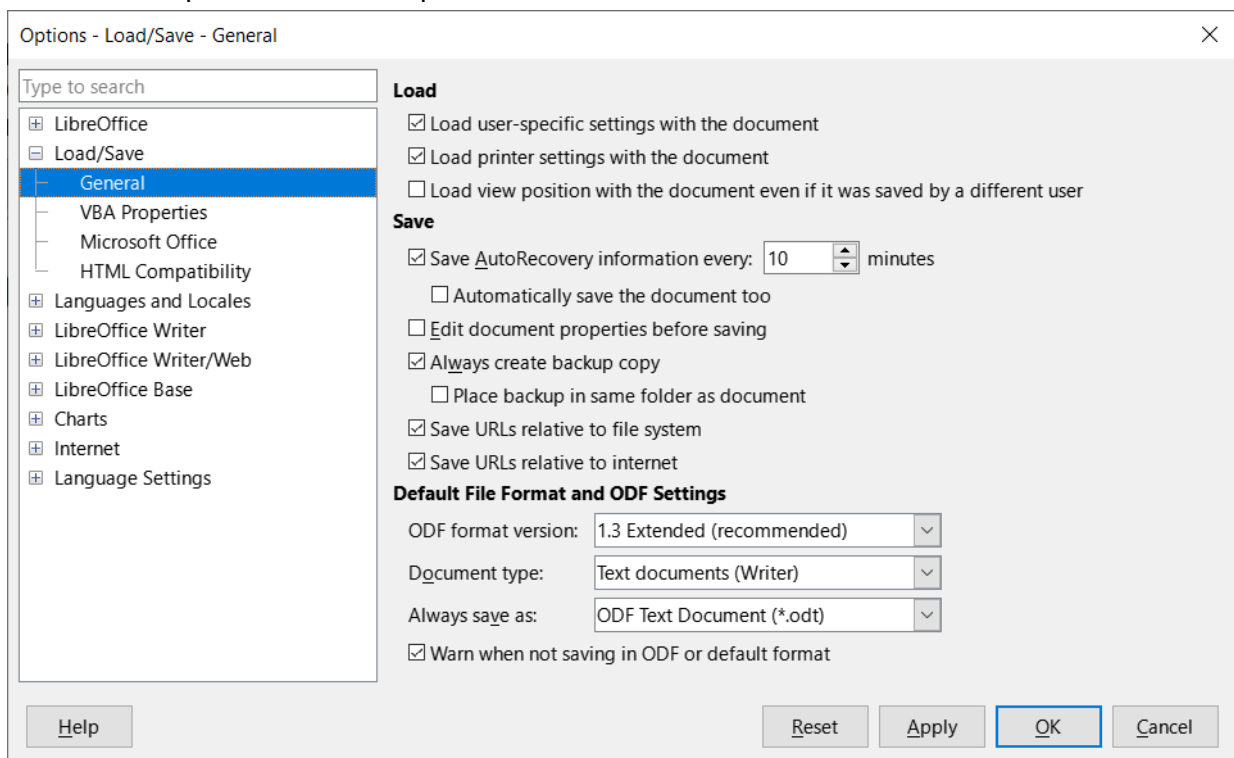

Figure 382: Options Load/Save dialog — General page

Save URLs relative to file system/Save URLs relative to the Internet

Selecting these options specifies the default for relative addressing of URLs in the file system and on the Internet. Relative addressing is only possible if the source document and the referenced document are both on the same drive.

A relative address always starts from the directory in which the current document is located. In contrast, absolute addressing always starts from a root directory. The following table demonstrates the difference in syntax between relative and absolute referencing:

Table 20: Examples of saving URLs

Examples	File system	Internet
relative	../images/img.jpg	../images/img.jpg
absolute	file:///c:/work/images/img.jp	http://myserver.com/work/images/img.jpg

Default File Format and ODF Settings

ODF format version

LibreOffice support the OpenDocument format (ODF) version 1.3 Extended. This format allows for improved functionality, but there may be backwards compatibility issues. The previous versions of LibreOffice support the file format ODF 1.2. However, previous file formats cannot store all new features of the newer version of LibreOffice. This version of LibreOffice can open and save documents in previous versions of ODF formats.

Document type

Specifies the document type to define the default file format.

Always save as

Specifies that documents of the type selected on the left are always saved as the file type selected from the drop-down list. Another file type for the current document can be selected in the Save as dialog.

Warn when not saving in ODF or default format

When selected, a warning message is displayed when saving a document in a format that is not the selected default format, or ODF format.

VBA properties

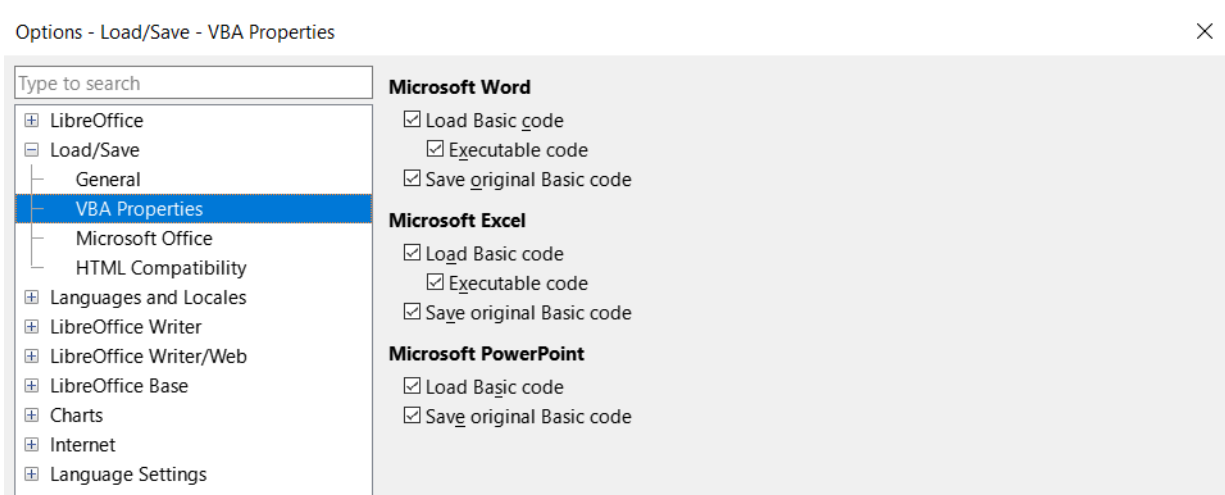

Figure 383: Options Load/Save dialog — VBA Properties page

On the VBA Properties page of the Options Load/Save dialog (Figure 383), the general properties for loading and saving Microsoft Office documents with VBA (Visual Basic for Applications) code are specified.

Microsoft Word

Select the settings for Microsoft Word documents.

Load Basic code

Loads and saves Basic code from a Microsoft document as a special LibreOffice Basic module with the document. When saving the document in OpenDocument format, the Basic code is saved as well. When saving in another format, the Basic code from the LibreOffice Basic IDE is not saved.

Executable code

If selected, the Visual Basic for Applications (VBA) code is loaded ready to be executed. If not selected, the VBA code is commented out so it can be inspected, but not run.

Note

After loading the VBA code, LibreOffice inserts the statement `Option VBASupport 1` in every Basic module to enable a limited support for VBA statements, functions and objects.

Save original Basic code

Specifies that the original Microsoft Basic code contained in the document is held in a special internal memory for as long as the document remains loaded in LibreOffice. When saving the document in Microsoft format, the Microsoft Basic code is saved again with the code in an unchanged form.

When saving in a format other than Microsoft Format, the Microsoft Basic Code is not saved. For example, if the document contains Microsoft Basic code and the document is saved in OpenDocument format, a warning is displayed stating that Microsoft Basic code will not be saved.

The *Save original Basic code* selection takes precedence over the *Load Basic code* selection. If both options are marked and the disabled Basic code is edited in the LibreOffice Basic IDE, the original Microsoft Basic code is saved when saving in Microsoft format.

To remove any possible Microsoft Basic macro viruses from a Microsoft document, deselect *Save original Basic code* and save the document in Microsoft format. The document is saved without the Microsoft Basic code.

Microsoft Excel

For information on *Load Basic code*, *Executable code*, and *Save original Basic code*, see **Microsoft Word** above.

Microsoft PowerPoint

For information on *Load Basic code* and *Save original Basic code*, see **Microsoft Word** above.

Microsoft Office

On the Microsoft Office page of the Options Load/Save dialog (Figure 384), the settings for importing and exporting Microsoft Office and other documents are specified.

Embedded Objects

Embedded Objects specifies how Microsoft Office objects, or other OLE objects, are imported and exported. These settings are valid even when no Microsoft, or other OLE,

server exists (for example, in UNIX), or when there is no LibreOffice OLE server ready for editing the OLE objects.

If an OLE server is active for the embedded object, then the OLE server is used to handle the object.

If no OLE server is active for MathType objects, then embedded MathType objects are converted to LibreOffice Math objects. For this conversion, the embedded MathType objects must not exceed the MathType 3.1 specifications.

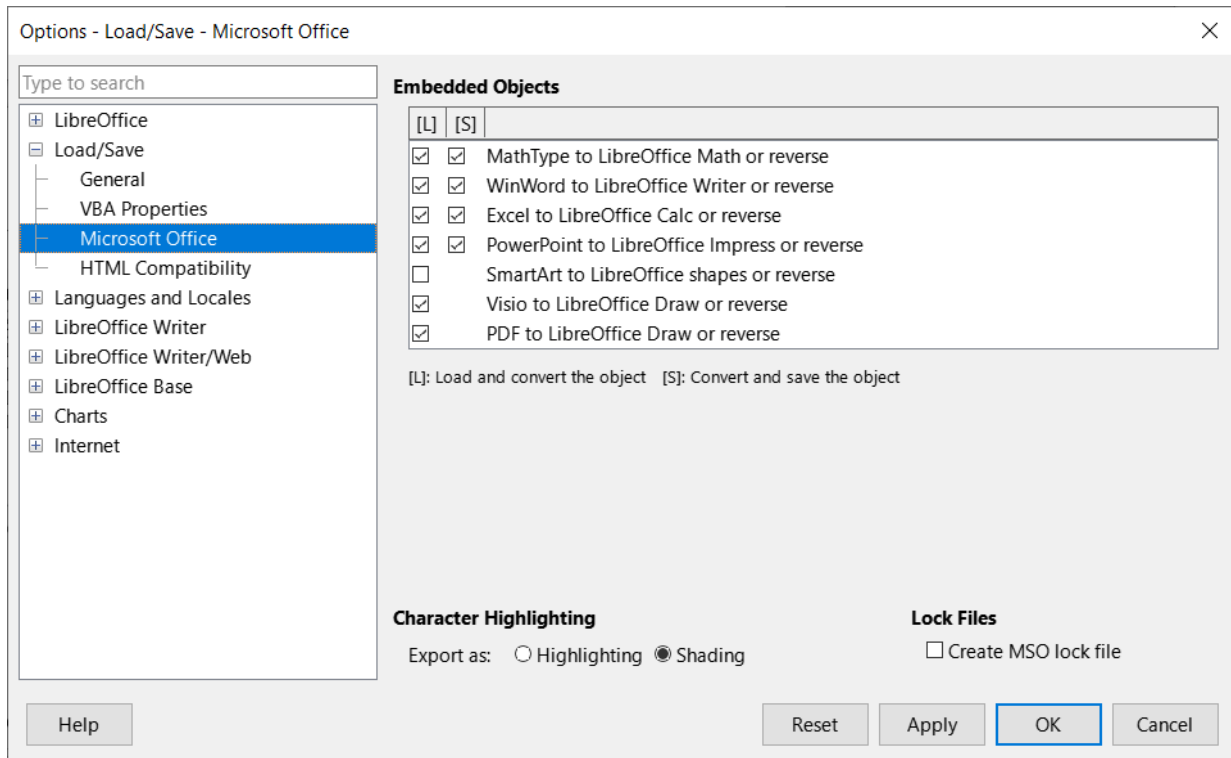

Figure 384: Options Load/Save dialog — Microsoft Office page

[L] and [S] Columns

Selecting the **[L]** and **[S]** columns displays the entries for OLE objects that can be converted when loading into LibreOffice **[L]** and/or when saving into a Microsoft format **[S]**.

Select the **[L]** column in front of the entry if a Microsoft or other OLE object, is to be converted into the specified LibreOffice OLE object when a Microsoft or other document is loaded into LibreOffice.

Select the **[S]** column in front of the entry if a LibreOffice OLE object is to be converted into the specified Microsoft OLE object when a document is saved in a Microsoft file format.

Character Highlighting

Microsoft Office has two character attributes similar to LibreOffice character highlighting. Use this control to select the attribute, highlighting or shading, that LibreOffice should use when exporting LibreOffice character highlighting to Microsoft Office file formats.

Highlighting

Exports the closest match between a LibreOffice highlighting color and one of the 16 Microsoft highlighting colors. This character attribute makes it easy for Microsoft Office users to edit with the highlighting tool in Microsoft Office applications.

Shading

Exports all RGB colors to the other Microsoft Office character attribute. This preserves color fidelity between LibreOffice and Microsoft Office documents, but Microsoft Office users must edit this character attribute with a tool that is not commonly used or easy to find in Microsoft Office applications. This is the default setting since LibreOffice 7.0.

Tip

The compatibility filter in the Character Highlighting Color dialog provides the Microsoft Office highlighting colors. Use those colors and choose *Highlighting* if both color fidelity and ease of editing is required for Microsoft Office users.

Lock files

Select **Lock files** to generate a Microsoft Office lock file in addition to the LibreOffice lock file. Lock files signal to applications that a resource or file should not be used until the lock is released. LibreOffice can read lock files generated by Microsoft Office.

HTML compatibility

On the HTML compatibility page of the Options Load/Save dialog (Figure 385), define the settings for HTML pages.

Font sizes

Use *Size 1* to *Size 7* to define the respective font sizes for the HTML `` to `` tags.

Import

Defines the settings for importing HTML documents.

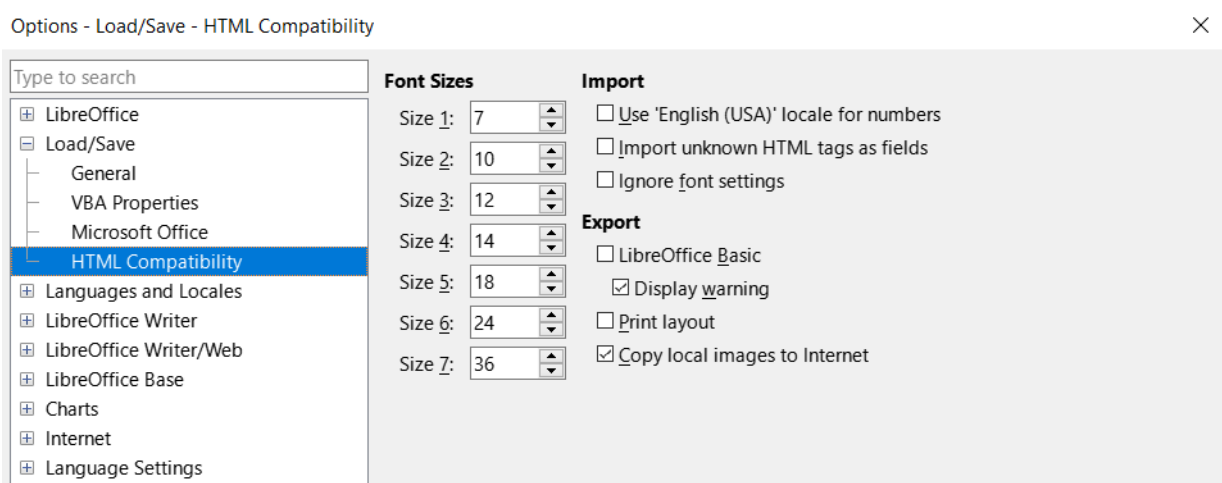

Figure 385: Options Load/Save dialog — HTML Compatibility page

Use 'English (USA)' locale for numbers

When importing numbers from an HTML page, the decimal separator and the thousands separator characters differ according to the locale of the HTML page. The clipboard, however, contains no information about the locale. For example, the characters "1.000" copied from a German Web page probably mean "one thousand" because the dot-on-the-line is the thousands separator in a German locale. If copied from an English Web page, the same characters stand for the number 1 as in "one dot zero zero zero".

If not selected, numbers are interpreted according to the setting in **Tools > Options > Languages and Locales** (macOS **LibreOffice > Preferences > Languages and Locales**). If marked, numbers are interpreted using the English (USA) locale.

Import unknown HTML tags as fields

Select this option if tags that are not recognized by LibreOffice are to be imported as fields. For an opening tag, an `HTML_ON` field is created with the value of the tag name. For a closing tag, an `HTML_OFF` is created. These fields are converted to tags in the HTML export.

Ignore font settings

Select this option to ignore all font settings when importing. The fonts that were defined in the HTML Page Style are the fonts used.

Export

LibreOffice Basic

Select this option to include the LibreOffice Basic instructions when exporting to HTML format.

This option must be selected before creating the LibreOffice Basic Script, otherwise it will not be inserted. LibreOffice Basic scripts must be located in the header of the HTML document. Once the macro is created in LibreOffice Basic IDE, it appears in the source text of the HTML document in the header.

Display warning

If selected, when exporting to HTML a warning is displayed stating that LibreOffice Basic macros will be lost.

Print layout

If selected, the print layout of the current document (for example, table of contents with justified page numbers and dot leaders) is exported as well. It can be read by LibreOffice, Mozilla Firefox, and MS Internet Explorer.



Note

The HTML filter supports CSS2 (Cascading Style Sheets Level 2) for printing documents. Note that these capabilities are only effective if print layout export is activated.

Copy local images to Internet

Select this option to automatically upload the embedded images to the Internet server when uploading using FTP. Use the Save As dialog to save the document and enter a complete FTP URL as the file name in the Internet.



Note

Some options cannot be reset once edited. Either undo the changes manually, or click **Cancel** and reopen the Options dialog.

Languages and Locales

Go to **Tools > Options > Language and Locale** (macOS **LibreOffice > Preferences > Language and Locale**) on the Menu bar to open dialogs where the properties for languages, writing aids and language tools can be defined.

Note

Searching in Japanese and **Asian Layout** pages are only visible if the Asian language support option in the Languages page is activated. **Complex Text Layout** page is only visible if the CTL support is activated.

General

On the General page of the Options Languages and Locales settings dialog (Figure 386), define the default languages and locale settings for documents.

Language of

User interface

Select the language used for the user interface, for example menus, dialogs, and help files. There must be at least one additional language pack installed, or a multi-language version of LibreOffice installed.

The *Default* entry selects the language of the user interface used by the computer operating system. If this language is not available in the LibreOffice installation, the language of the LibreOffice installation is the default language.

Formats

Locale setting

Specifies the locale setting of the country setting. This influences settings for numbering, currency and units of measure.

The *Default* entry selects the locale used by the operating system. A change in this field is immediately applicable.

Default currency

Specifies the default currency used by the currency format and the currency fields. If the locale setting is changed, the default currency changes automatically.

The *Default* entry applies to the currency format that is assigned by the selected locale setting. A change in *Default currency* will change all open documents. Also, dialogs and icons that use the currency format also changes.

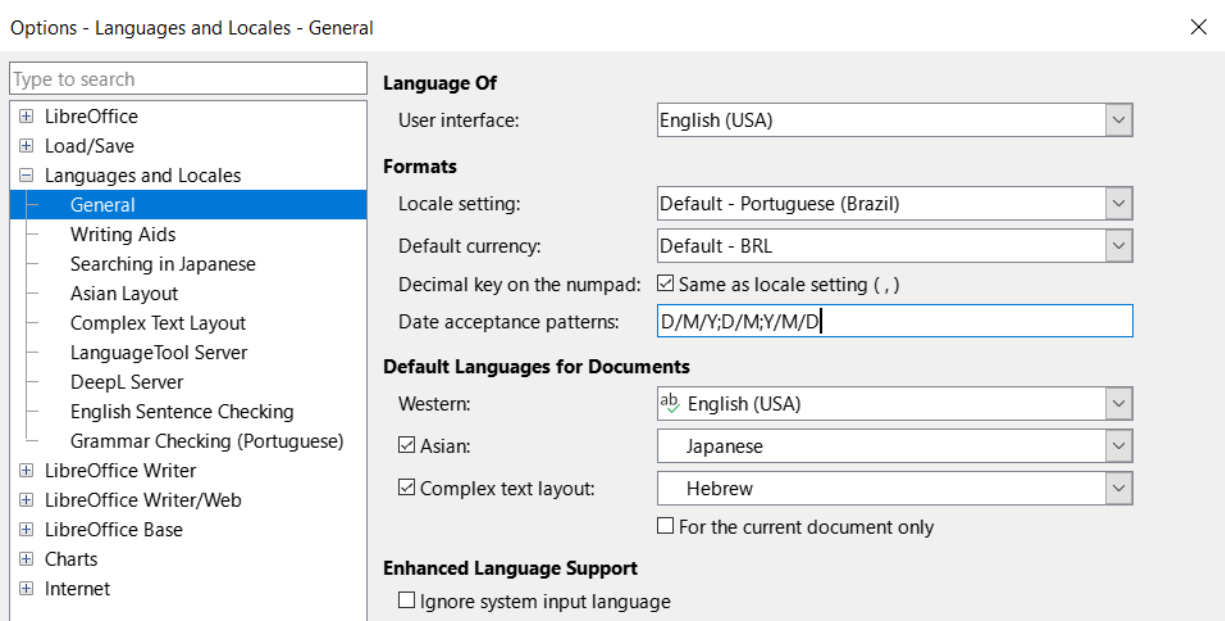

Figure 386: Options - Languages and Locales dialog — Languages page

Decimal key on the numpad:

If *Same as locale setting* is selected, the decimal separator key that is set in the computer system is used when the respective key on the number pad is pressed. If *Same as locale setting* is not selected, the character used by the keyboard driver software is inserted.

Date acceptance patterns

Specifies the date acceptance patterns used by the current locale. Calc spreadsheet and Writer table cell input have to match locale dependent date acceptance patterns before being recognized as a valid date.

Type numbers and characters that correspond to the defined date acceptance patterns into a table cell, and then move the cursor outside of the cell. LibreOffice automatically recognizes the data entry and converts the input to the correct date format.

The initial patterns in *Date acceptance patterns* are determined by the locale setting, but these default patterns can be modified and more patterns added. Use a semi-colon (;) to separate each pattern.



Note

The spell check for the selected language only functions when the corresponding language module is installed. A language entry has a check mark in front of it if spell checking is activated for the selected language.

Default Languages for Documents

Specifies the languages for spelling, thesaurus, and hyphenation.

Western

Specifies the language used for the spelling check function in western alphabets.

Asian

When selected, activates Asian languages support. The corresponding Asian language settings in LibreOffice can now be defined. For example, when writing Chinese, Japanese or Korean characters, selecting *Asian* activates the support for these languages in the user interface.

Complex text layout

Specifies the language for the complex text layout spelling check (e.g., Devanagari, Arabic, Hebrew, Thai, etc.).

For the current document only

When selected, specifies that the settings for default languages are valid only for the current document.

Enhanced language support

Ignore system input language

Indicates whether changes to the system input language, or keyboard, are ignored. If ignored, when new text is typed that text follows the document language or current paragraph, not the current system language.



Note

Some options cannot be reset once edited. Either undo the changes manually, or click **Cancel** and reopen the Options dialog.

Writing Aids

On the Writing Aids page of the Options Languages and Locales dialog (Figure 387), the properties of spelling, thesaurus and hyphenation can be specified.

Available Language Modules

Lists the installed language modules in LibreOffice. A language module can contain one, two or three sub-modules: spelling, hyphenation and thesaurus. Each sub-module is available in one or more languages. Selecting a module name activates all available sub-modules simultaneously. Deselecting a module name, deactivates all available sub-modules simultaneously. To activate or deactivate individual sub-modules, click on **Edit** to open the Edit Modules dialog.

Note

The configuration allows two folders: one folder where a user has write permissions, and one folder without write permissions. A user can only edit and delete the user dictionaries that are located in the writable path. Other dictionaries can be read only.

Edit

To edit a language module, click on **Edit** to open the Edit Modules dialog. Select, or deselect, each sub-module as required.

User-defined dictionaries

Lists the available user dictionaries. Select the user dictionaries required for spelling and hyphenation.

New

Opens the New Dictionary dialog where the details of a new user-defined dictionary are added and the language specified. Click on **Help** for more information on the options available for the New Dictionary dialog.

Edit

Opens the Edit Custom Dictionary dialog allowing adding new entries and editing existing entries in a custom dictionary. When a custom dictionary is edited, a check is made on the status of the file. If the file is write-protected, it cannot be changed. **New** and **Delete** are deactivated. Click on Help for more information on the options available for the Edit Custom Dictionary dialog.

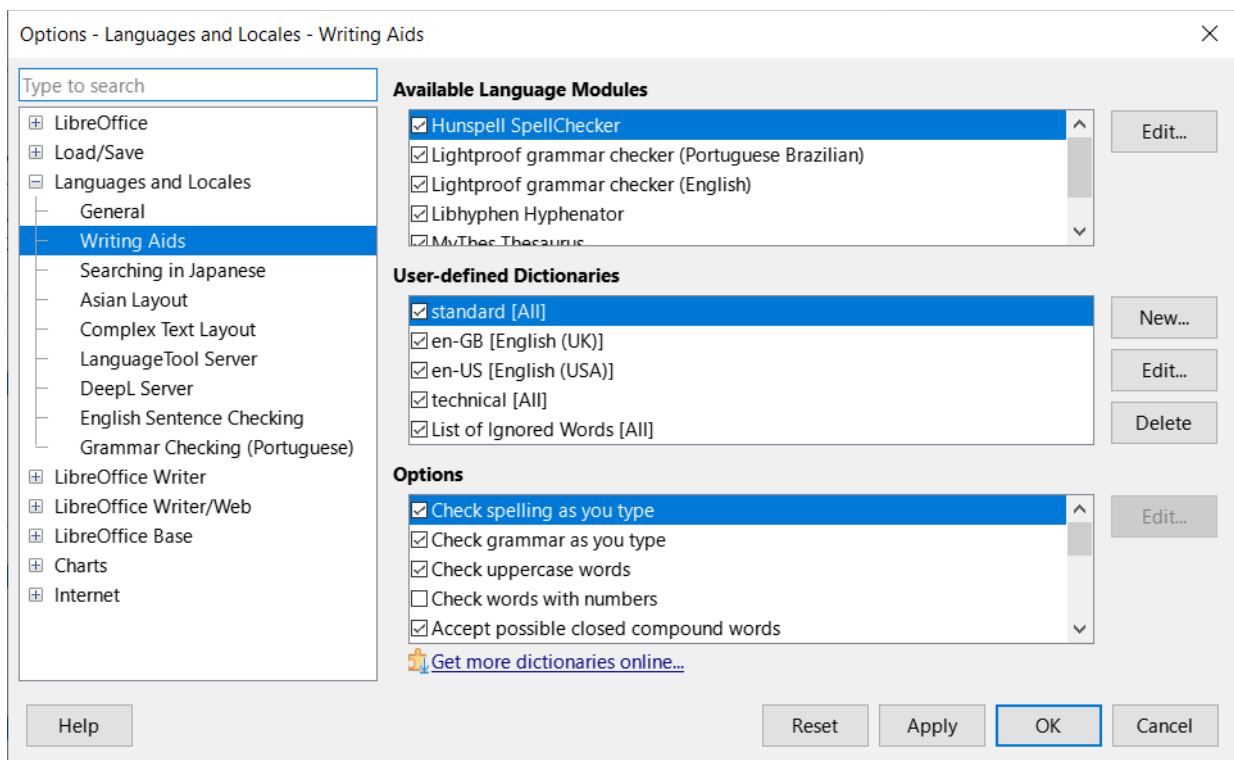

Figure 387: Options Languages and Locales dialog — Writing Aids page

Options

Defines the options for spell check and hyphenation.

Check spelling as you type

Automatically checks spelling as text is typed and underlines errors.

Typing errors are highlighted in the document with a red wavy underline. If the cursor is placed over a highlighted word, a context menu opens with a list of suggested corrections. Select a suggested correction to replace the suspect word with the suggestion. If the same mistake is made again while editing the document, the mistake is marked as an error again.

To place a word into the AutoCorrect replacement table, right-click on the word and select **AutoCorrect Options** from the context menu to open the AutoCorrect dialog. Select from the available options and the word is placed in the AutoCorrect replacement table.

Check grammar as you type

Any errors of grammar as text is typed into a document are highlighted with a blue wavy underline.

Check upper-case words

Specifies that capitalization is checked during a spell check.

Check words with numbers

Specifies that words containing numbers, as well as letters, are to be checked.

Check special regions

Specifies that special regions, such as drawing text, text in headers and footers, document tables, and text frames, are to be checked during a spell check.

Minimal number of characters for hyphenation

Specifies the minimal number of characters required for automatic hyphenation to be applied.

Characters before line break

Sets the minimal number of characters for the word to be hyphenated for it to remain at the end of the line.

Characters after line break

Specifies the minimal number of characters of a hyphenated word required at the beginning of the next line.

Hyphenate without inquiry

Specifies that there are no prompts for manual hyphenation. If not selected, when a word is not recognized it opens a dialog with hyphenation options.

Hyphenate special regions

Specifies that hyphenation is carried out in footnotes, headers and footers.

Edit

To change a value in an option, select the entry. If applicable, click on **Edit** to open a dialog allowing a new value to be entered.



Some options cannot be reset once edited. Either undo the changes manually, or click **Cancel** and reopen the Options dialog.

Installing language dictionaries

LibreOffice automatically installs several language modules when it is installed on a computer. Each language module can contain up to three submodules: spelling dictionary, hyphenation dictionary, and thesaurus. These language modules are usually referred to as dictionaries in LibreOffice.

Additional dictionaries can be installed as extensions. An example of adding another language dictionary is as follows:

- 1) Go to **Tools > Language > More Dictionaries Online** on the Menu bar to open the Extension Dictionaries dialog.
- 2) Select the required dictionary from the list of available dictionaries.
- 3) If necessary, click on the website link to find out more information on the selected dictionary.
- 4) Click on **Install** below the required dictionary and the dictionary is installed into LibreOffice.
- 5) Click on **Close** to close the Extensions Dictionary dialog.
- 6) Make sure all documents are saved and closed, then restart LibreOffice for the new dictionary to register in LibreOffice.

Searching in Japanese

Defines the search options for Japanese. These commands can only be accessed after support for Asian languages is enabled. Go to **Tools > Options > Language and Locale > General** (macOS **LibreOffice > Preferences > Language and Locale > General**) on the Menu bar to enable these options.

On the Searching in Japanese page of the Options Languages and Locales dialog (Figure 388) the search properties for Japanese can be specified.

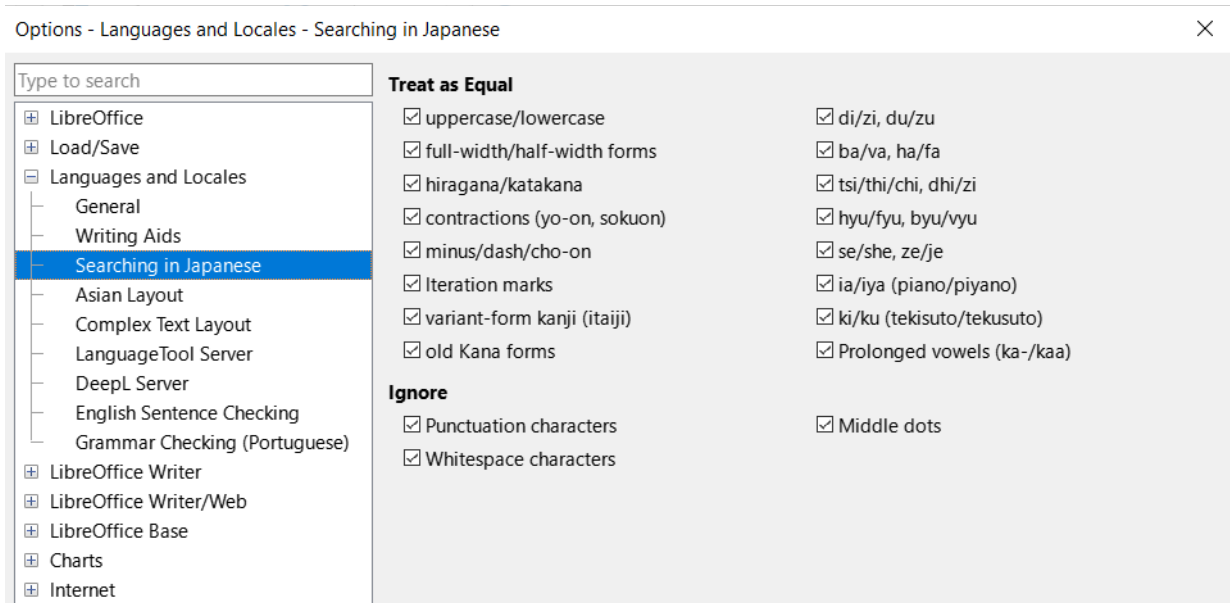

Figure 388: Options Languages and Locales dialog — Searching in Japanese page

Treat as equal

Specifies the options to be treated as equal during a search.

Ignore

Specifies the characters to be ignored during a search.

Asian layout

Defines the typographic default settings for Asian text after support for Asian languages has been enabled. To enable these options, go to **Tools > Options > Languages and Locales > Languages** (macOS LibreOffice > Preferences > Languages and Locales > Languages) on the Menu bar.

On the Asian Layout page of the Options Languages and Locales dialog (Figure 389), the properties for Asian Layout can be specified.

Kerning

Defines the default settings for kerning between individual characters.

Western text only

Specifies that kerning is only applied to Western text.

Western text and Asian punctuation

Specifies that kerning is applied to both Western text and Asian punctuation.

Character spacing

Defines the default settings for character spacing in Asian texts, cells, and drawing objects.

No compression

Specifies that no compression occurs.

Compress only punctuation

Specifies that only the punctuation is compressed.

Compress punctuation and Japanese Kana

Specifies that punctuation and Japanese Kana are compressed.

First and last characters

Defines the default settings for first and last characters.

Language

Specifies the language where first and last characters are defined.

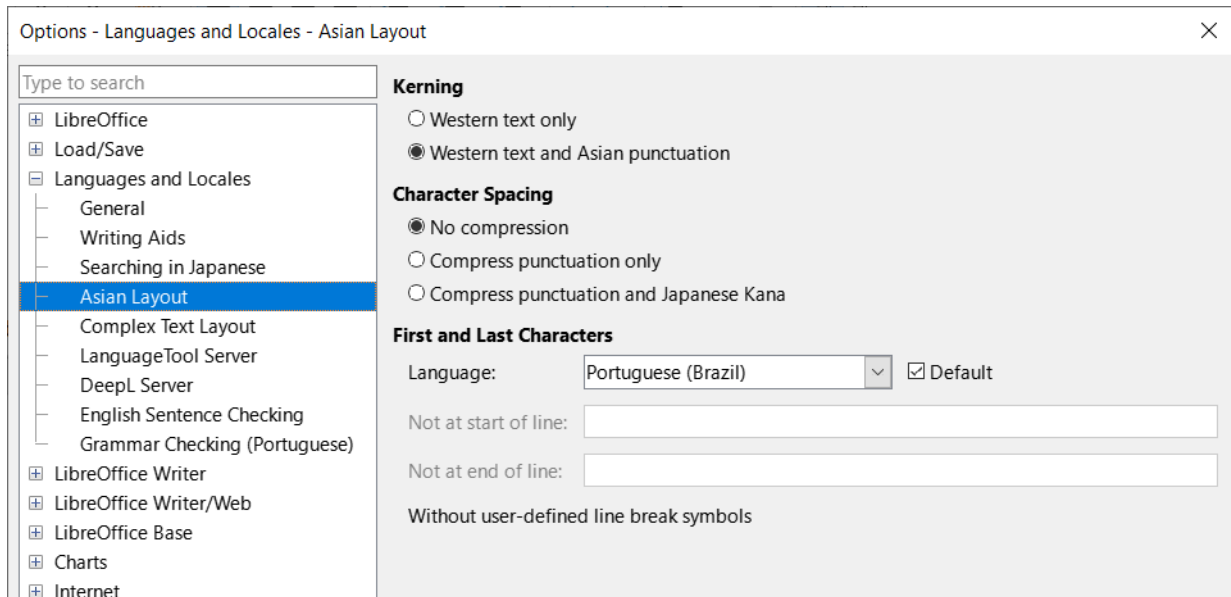

Figure 389: Options Languages and Locales dialog — Asian Layout dialog

Default

When *Default* is selected, the following two text boxes are filled with the default characters for the selected language:

Not at start of line

Specifies the characters that will not appear alone at the beginning of a line. If a character typed here is positioned at the beginning of a line after a line break, it is automatically moved to the end of the previous line. For example, an exclamation point at the end of a sentence never appears at the start of a line if it is listed in the *Not at start of line* list.

Not at end of line

Specifies the characters that will not appear alone at the end of a line. If a character typed here is positioned at the end of a line due to a line break, it is automatically moved to the beginning of the next line. For example, a currency symbol that appears in front of an amount never appears at the end of a line if it is listed in the *Not at end of line* list.

Complex Text Layout

Defines the options for documents that use Complex Text Layouts (CTL). To enable these options, go to **Tools > Options > Language and Locale > General** (macOS **LibreOffice > Preferences > Language and Locale > General**) on the Menu bar. On the Complex Text Layout page of the Options Languages and Locales dialog (Figure 390), the options for Complex Text Layout can be specified.

Currently, LibreOffice supports Hindi, Thai, Hebrew, and Arabic as CTL languages.

If the text flow from right to left is selected, embedded Western text still runs from left to right. The cursor responds to the arrow keys. The right arrow key moves the cursor toward the text end and the left arrow key moves the cursor toward the text start.

Change the text writing direction directly by using one of the following keyboard combinations. These keyboard combinations only work when CTL support is enabled.

- Switch to right-to-left text entry — *Ctrl+Shift+D* or *Ctrl+Right Shift Key* (macOS $\text{⌘}+\text{Shift}+D$ or $\text{⌘}+\text{Right Shift Key}$).
- Switch to left-to-right text entry — *Ctrl+Shift+A* or *Ctrl+Left Shift Key* (macOS $\text{⌘}+\text{Shift}+A$ or $\text{⌘}+\text{Left Shift Key}$).

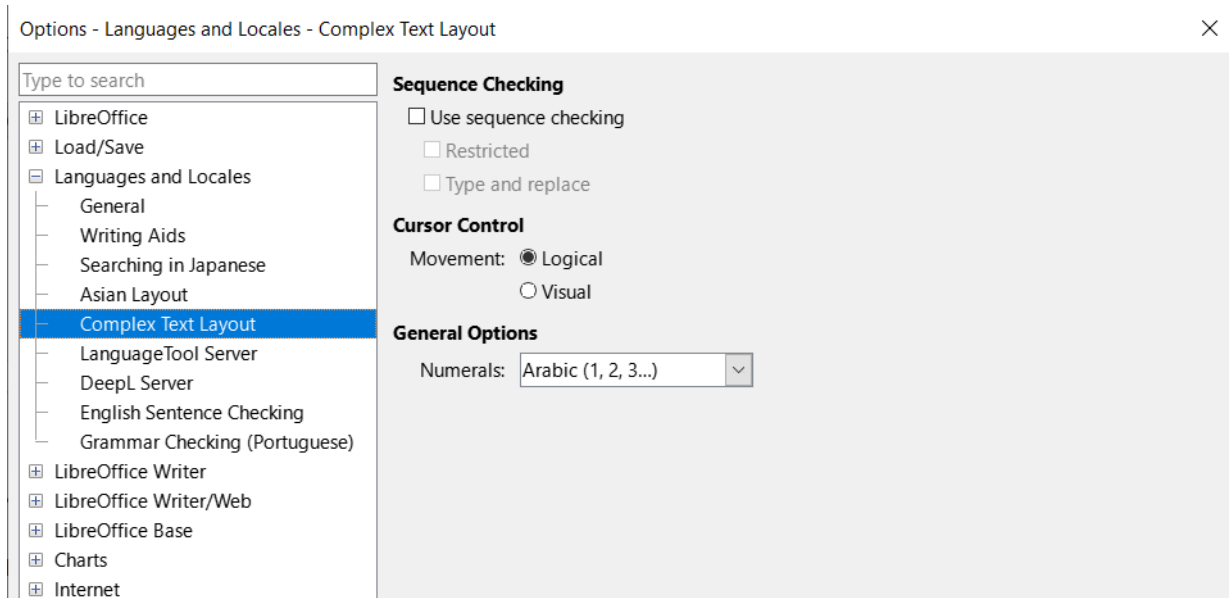

Figure 390: Options Languages and Locales dialog — Complex Text Layout page

In multicolumn pages, sections, or frames that are formatted with text flow from right to left, the first column is the right column and the last column is the left column.

Sequence Checking

In languages, for example Thai, rules specify that certain characters are not allowed next to other characters. If Sequence Input Checking (SIC) is enabled, LibreOffice will not allow a character next to another specific character if it is forbidden by a rule.

Use sequence checking

Enables sequence input checking for languages.

Restricted

Prevents the use and the printing of illegal character combinations.

Type and replace

When selected, allows typing and replacing of characters.

Cursor control

Select the type of cursor movement and text selection for mixed text (right-to-left mixed with left-to-right text direction).

Logical

Using the *Right Arrow* key moves the text cursor towards the end of the current text. Using the *Left Arrow* key moves the text cursor towards the beginning of the current text.

Visual

Using the *Right Arrow* key moves the text cursor in the right-hand direction. Using the *Left Arrow* key moves the text cursor in the left-hand direction.

General Options

General Options setting is not saved in the document but in the LibreOffice configuration.

Numerals

Selects the type of numerals used within text, text in objects, fields, and controls, in all LibreOffice modules. Only cell contents of LibreOffice Calc are not affected.

Arabic — all numbers are shown using Arabic numerals. This is the default.

Hindi — all numbers are shown using Hindi numerals.

System — all numbers are shown using Arabic, or Hindi, numerals according to the locale settings defined by the computer system locality.

Language tool server

On the Language Tool Server page of the Options Languages and Locales dialog (Figure 391), select the Enable Language Tool to use a language tool assistant available for LibreOffice. If necessary, click on the link <https://languagetool.org/legal/privacy> to access the privacy policy for using the language tool assistant.

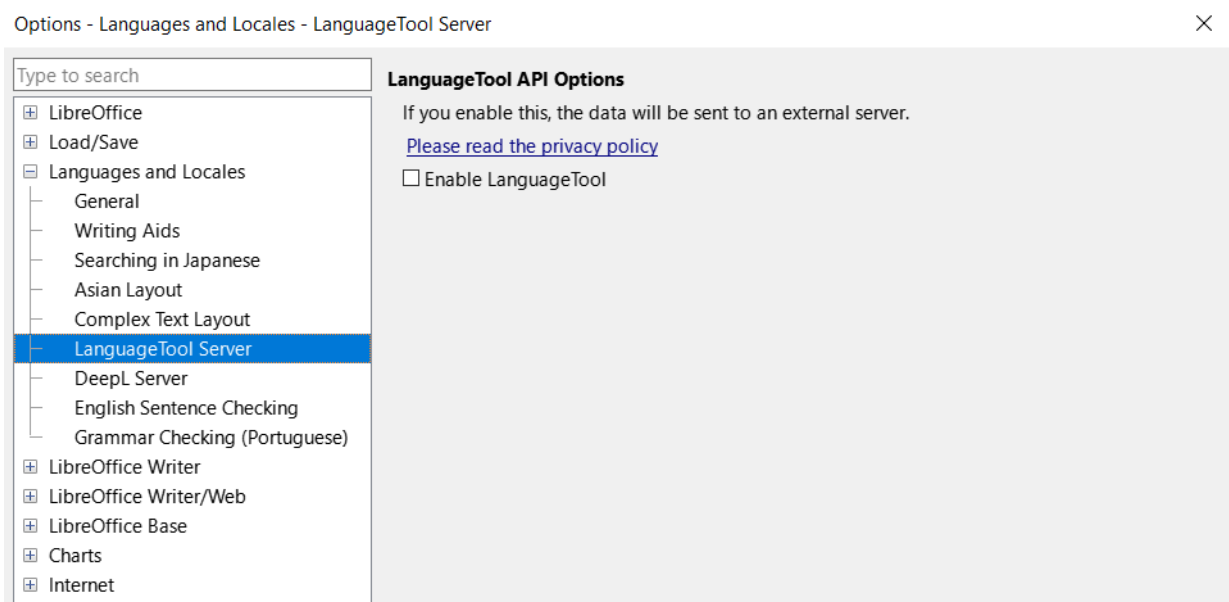

Figure 391: Options Languages and Locales dialog — Language Tool Server page

English sentence checking

On the English Sentence Checking page of the Options Languages and Locales dialog (Figure 392), the options for checking the language used in a document can be selected.

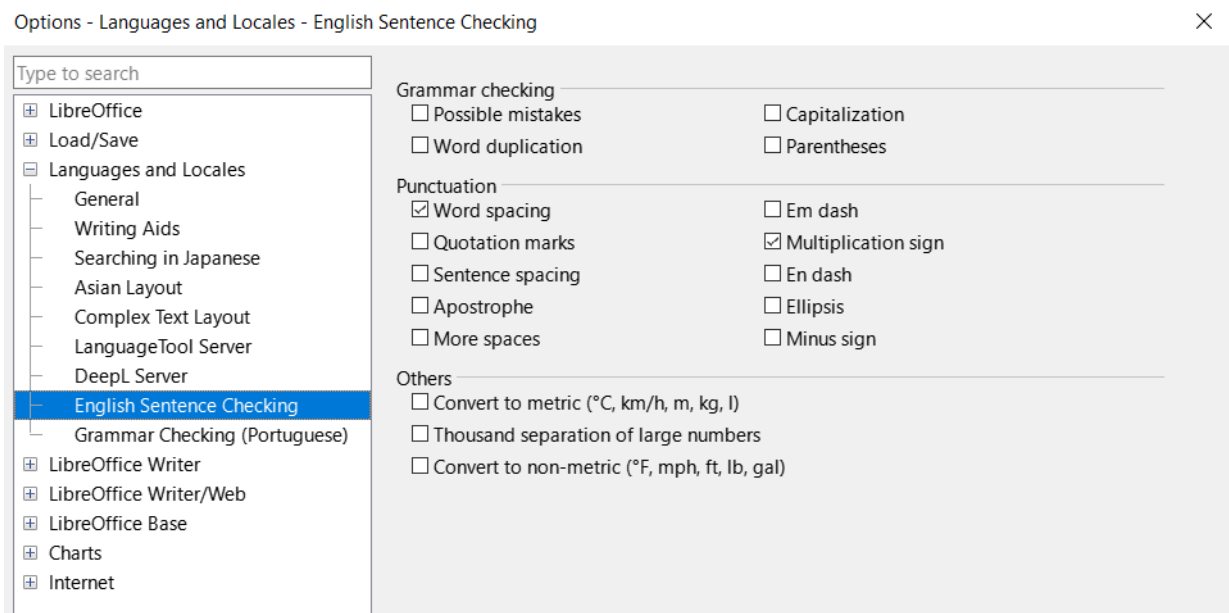

Figure 392: Options Languages and Locales dialog — English Sentence Checking page

Chart color options

In the Default Colors page of the Options Charts dialog (Figure 393) the default colors are specified for LibreOffice charts. Any colors changed only apply to newly created charts.

Chart Colors

The color selected in Color Table is assigned to the selected data row.

Color Table

Select a color palette from the drop-down list to use as a source for chart colors.

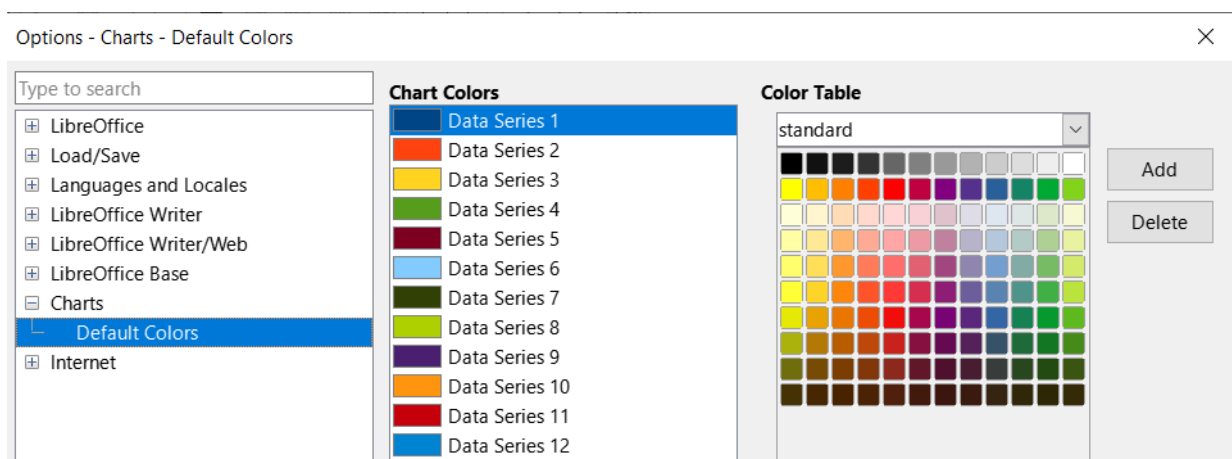

Figure 393: Options Charts dialog — Default Colors page

Add

Click on **Add** to add a data series in Chart Colors.

Delete

Click on **Delete** to remove the selected data series from the Chart Colors list.

Internet options

In the Options Internet dialog (Figure 394) the following Internet settings are located on separate dialog pages, depending on the computer operating system.

- **Proxy** page — enter the proxy settings for use with LibreOffice.
- **MediaWiki** page — A MediaWiki publisher is included with Windows and Linux. A Java Runtime Environment (JRE) is required for this feature to work.

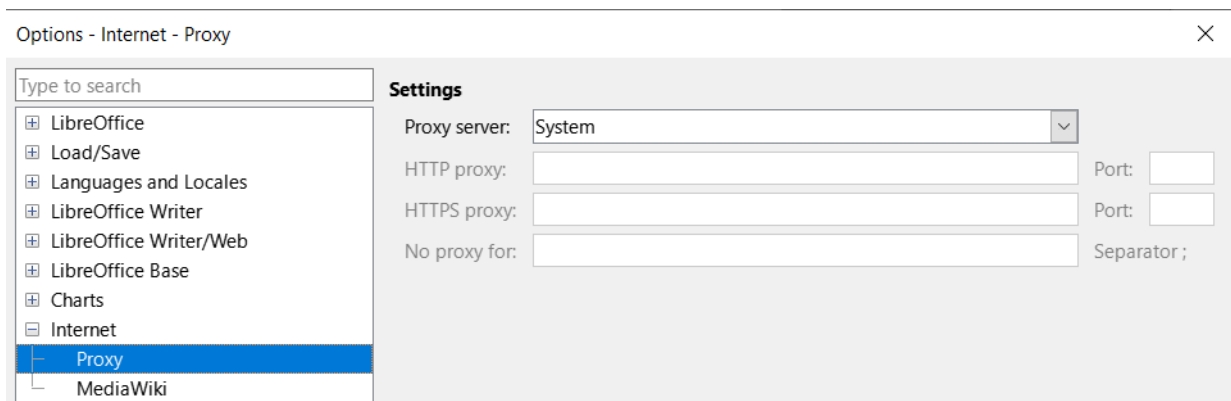

Figure 394: Options Internet dialog — Proxy page

AutoCorrect functions

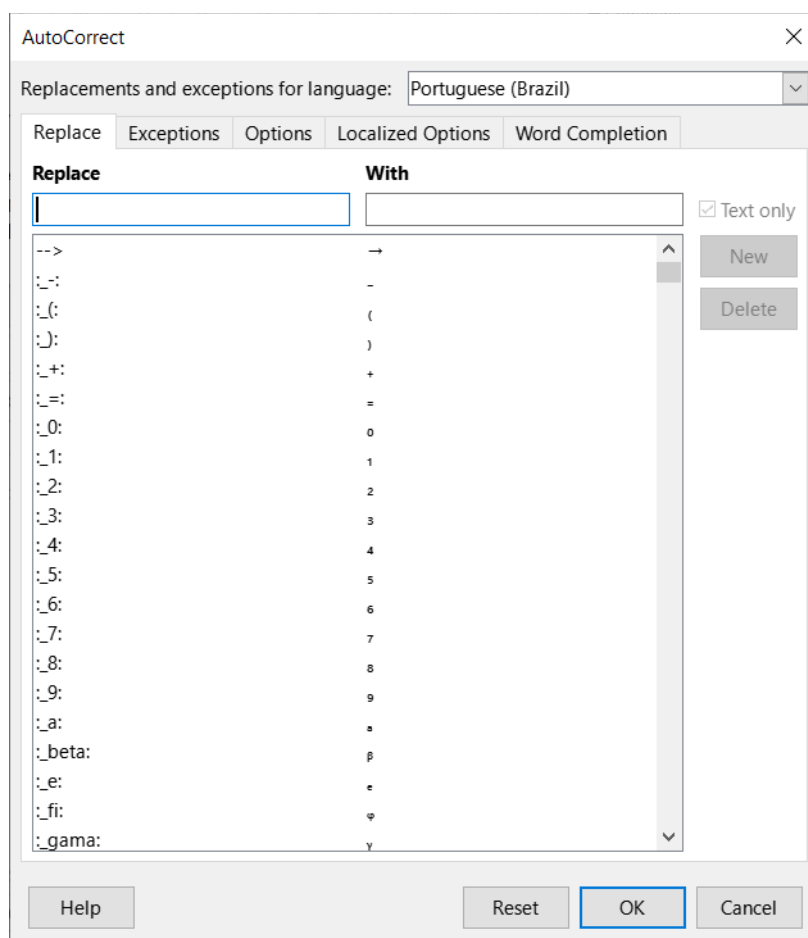

Figure 395: AutoCorrect dialog

The AutoCorrect functions in LibreOffice automatically detect and replace common symbols, spelling mistakes, and grammar mistakes. Occasionally, AutoCorrect changes something that should have been kept. If unexplained changes appear in a document, the AutoCorrect settings are often the cause. For more information on AutoCorrect, refer to the relevant user guides for each module.

- 1) Go to **Tools > AutoCorrect > AutoCorrect Options** on the Menu bar to open AutoCorrect dialog (Figure 395). A document must be opened for this menu item to appear.
- 2) Select each tab in the dialog to add, edit, and delete AutoCorrect options. In Writer, the dialog has five tabs. In the other LibreOffice modules, the dialog only has four tabs.
- 3) Click **OK** to save the changes and close the dialog.



LibreOffice
Community



Chapter 13, Customizing LibreOffice

Introduction

This chapter describes some common customizations that can be carried out, as follows:

- Menus, toolbars, keyboard shortcuts, and the tabbed interface in LibreOffice can be customized.
- New menus and toolbars assign macros to events that can be added.
- Different user interface variants can be selected and used.

Customizations can also be carried out by adding extensions that can be installed from the LibreOffice website or from other providers. For more information, see “Adding extensions” on page 542.



Note

Customized menus and toolbars can be saved in a template. The customized menus and toolbars are created in a document and the document is then saved as a template. For more information, see Chapter 4, Working with Styles, Templates, and Hyperlinks.

Menu customization

Menus and commands on the Menu bar or context menus can be added, rearranged, removed, or other changes made. To customize menus, go to **Tools > Customize** on the Menu bar and select the **Menus** page (Figure 396), or the **Context Menu** page, from the context menu. The **Context Menu** page is similar to the **Menus** page.

Customizing existing menus

The following is an example of customizing a menu in LibreOffice Writer. The menus in the other LibreOffice modules are also customized using similar procedures.

Adding commands

- 1) Go to **Tools > Customize** on the Menu bar to open the Customize dialog.
- 2) Click on **Menus** to open the **Menus** page (Figure 396). In the **Scope** drop-down list, LibreOffice Writer appears as the selected module.
- 3) In **Target**, select the menu for customization from the drop-down list. This drop-down list also includes the submenus available in the selected menu.
- 4) In **Assigned Commands**, check that the required command is not already listed for the selected menu. This may require scrolling through the list of commands.
- 5) If necessary, enter a command name in the **Search** text box to locate the command in the **Available Commands** list.
- 6) If necessary, select a command category from the **Category** drop-down list. By default, *All commands* is displayed as the category.
- 7) Select the required command in the **Available Commands** list. This may require scrolling through the list of commands.
- 8) Click on the right arrow to add the required command to the **Assigned Commands** list.
- 9) If necessary, click on the up arrow, or down arrow, to move the command into its correct position in the **Assigned Commands** list.

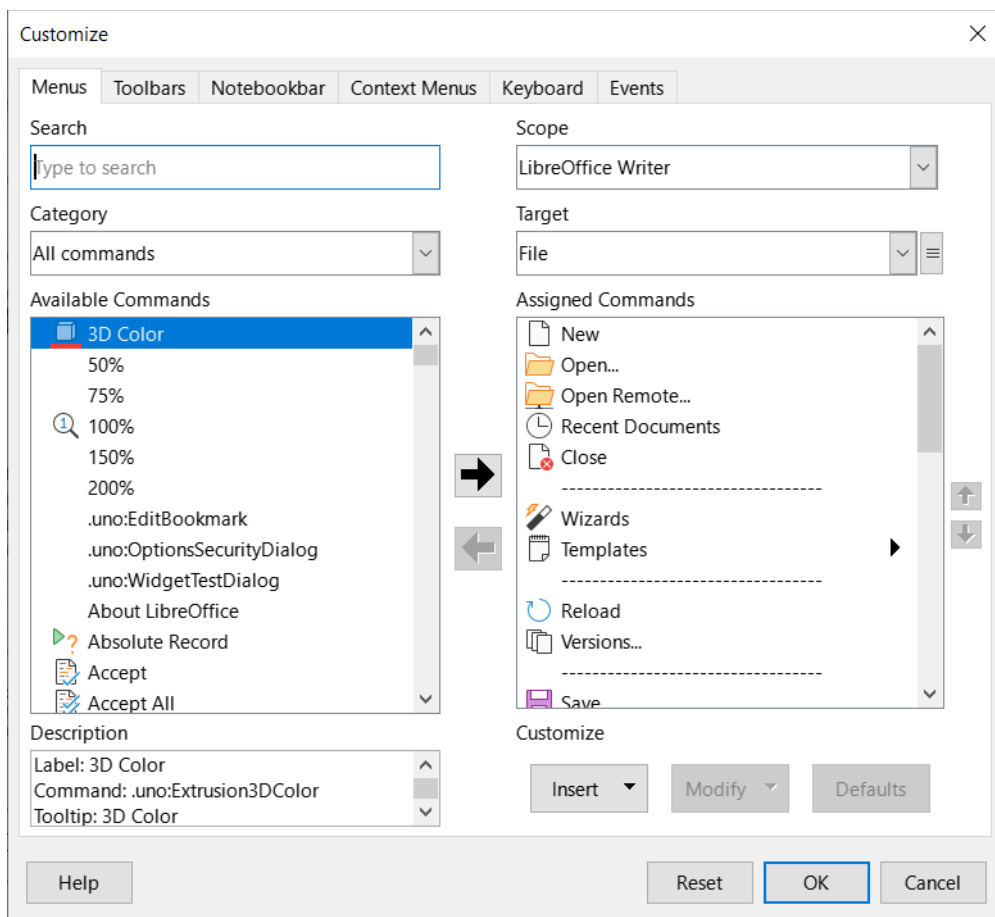

Figure 396: Customize dialog — Menus page

- 10) If necessary, insert a menu separator above the newly inserted command as follows:
 - a) Select the newly inserted command in the **Available Commands** list.
 - b) Click on **Insert** and select *Insert Separator* from the drop-down list.
- 11) If necessary, insert a submenu as follows:
 - a) Select the newly inserted command in the **Available Commands** list.
 - b) Click on **Insert** and select *Insert Submenu* from the drop-down list.
 - c) Enter a name for the submenu in the Add Submenu dialog that opens.
 - d) Click **OK** to create the submenu and close the dialog.
- 12) If necessary, rename the newly inserted command as follows:
 - a) Select the newly inserted command in the **Available Commands** list.
 - b) Click on **Modify** and select *Rename* from the drop-down list.
 - c) Enter a new name for the command in the Rename Menu dialog that opens.
 - d) Click **OK** to rename the command and close the dialog.
- 13) Click **OK** to save the changes to the menu and close the Customize dialog.

Removing commands

- 1) Go to **Tools > Customize** on the Menu bar to open the Customize dialog.
- 2) Click on **Menus** to open the **Menus** page. In the **Scope** drop-down list, LibreOffice Writer appears as the selected module.

- 3) Select the command for removal in the **Assigned Commands** list.
- 4) Click on the left arrow to move the selected command to the **Available Commands** list.
- 5) Click **OK** to save the changes to the menu and close the Customize dialog.

Creating new menus

The following is an example of creating a new menu in LibreOffice Writer. The menus in the other LibreOffice modules are also created using a similar procedure.

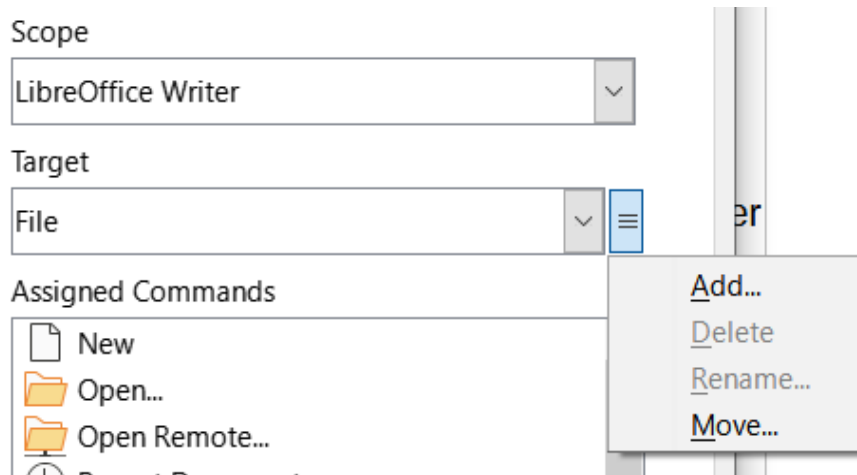

Figure 397: Adding new menu

- 1) Go to **Tools > Customize** on the Menu bar to open the Customize dialog.
- 2) Click on **Menus** to open the **Menus** page.
- 3) Click on the three bars Ξ next to the **Target** drop-down list to open a context menu (Figure 397).
- 4) Select **Add** from the context menu to open the New Menu dialog (Figure 398).
- 5) Enter a name for the new menu in the **Menu name** text box. The name of the new menu appears at the bottom of the menu list in **Menu position**.
- 6) Select the new menu and use the up and down arrows to reposition the new menu in the **Menu position** list.
- 7) Click **OK** to close the New Menu dialog and the new menu name appears in **Target** with the **Assigned Commands** box empty.
- 8) Add commands to the new menu. See “Adding commands” on page 532 on how to add menu commands.
- 9) Click **OK** to close the Customize dialog.

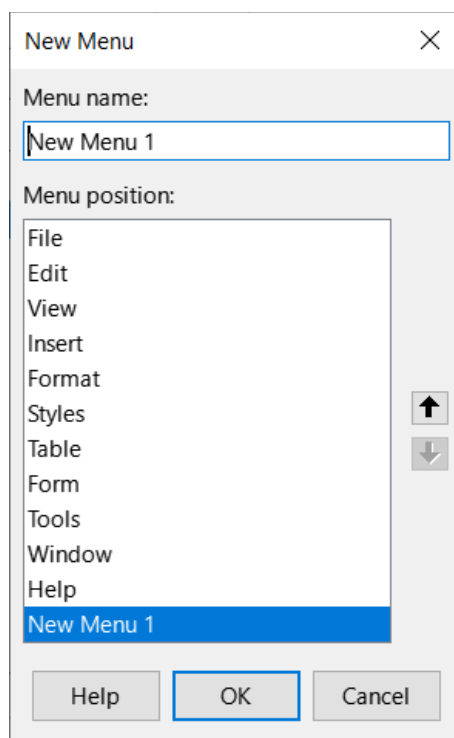

Figure 398: New Menu dialog

Creating a shortcut character

This can be done only on the Windows operating system. A character can be assigned as a keyboard shortcut for menu commands. The character is underlined in the name of the menu command. For example, the character **O** is used to open the **Format** menu on the Menu bar when the key combination **Alt+O** is used.

Adding a character as a keyboard shortcut to a menu command is as follows:

- 1) Go to **Tools > Customize** on the Menu bar to open the Customize dialog.
- 2) Click on **Menus** to open the **Menus** page.
- 3) Select the menu from the **Target** drop-down list.
- 4) Select the menu command from the **Assigned Commands** list.
- 5) Click on the three bars **☰** ("hamburger menu") next to the **Target** drop-down list to open a context menu.
- 6) Click on **Rename** from the context menu to open the Rename dialog.
- 7) Add a tilde (~) before the character to be used as the keyboard shortcut.
- 8) Click **OK** to save the change and close the Rename dialog.
- 9) Click **OK** to close the Customize dialog. The character appears with an underline in the menu item name.

Note

When assigning a character as a keyboard shortcut, make sure the character used is **NOT** already assigned to another menu command.

Toolbar customization

Toolbars can be customized in several ways, such as locking the position of a docked toolbar, and adding or deleting tools available on a toolbar. New toolbars can also be created if required. This section describes how to create new toolbars and add or delete icons on existing toolbars.

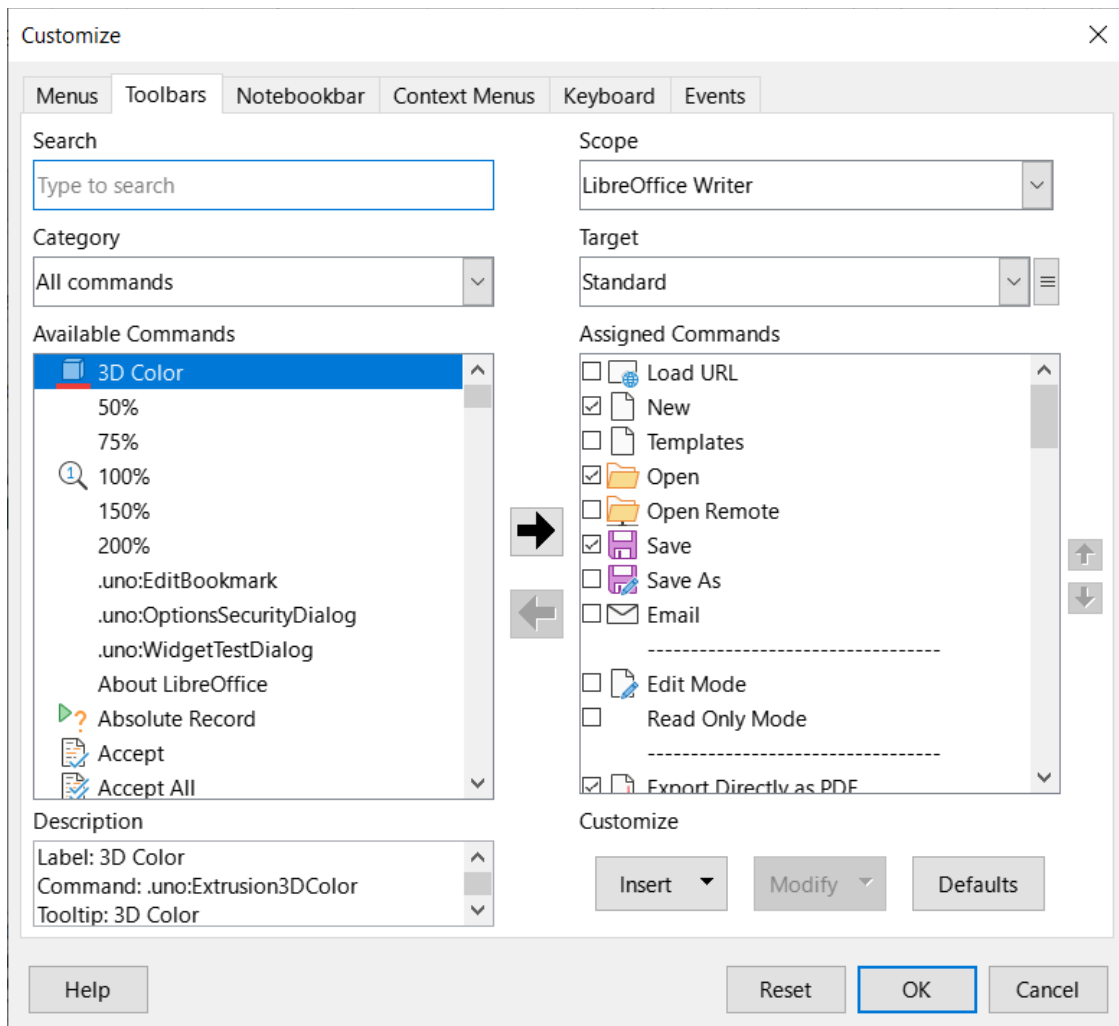

Figure 399: Customize dialog — Toolbars page

The Toolbars page on the Customize dialog (Figure 399) is used to customize a toolbar, or create a new toolbar and is opened using one of following methods:

- Right-click in an empty space on a toolbar and select **Customize Toolbar** from the context menu.
- Go to **View > Toolbars > Customize** on the Menu bar.
- Go to **Tools > Customize** on the Menu bar and click on the **Toolbars** tab when the dialog opens.

Note

When customizing or creating toolbars in LibreOffice, make sure that there is a LibreOffice module open, for example Writer, and at least one document open. If there is no LibreOffice module, or document, open, then toolbar customization or creation cannot be carried out.

Toolbar customization

Adding tools

- 1) Open the Customize dialog and click on **Toolbars** to open the **Toolbars** page.
- 2) In the **Scope** drop-down list, select the LibreOffice module displayed, or one of the listed documents.

Note

If a listed document is selected in the **Scope** drop-down list, then any customization to a toolbar is only available for that selected document.

- 3) In the **Target** drop-down list, select the toolbar for customization. The tools on the selected toolbar are displayed in the **Assigned Commands** list.
- 4) Select a tool in the **Available Commands** list. By default, all available tools are displayed in the **Available Commands** list.
- 5) Alternatively, and to reduce the number of tools listed in **Available Commands**, use one of the following methods:
 - Enter a search term in the **Search** box
 - Select a category in the **Category** drop-down list.
- 6) Select the required tool and click on the right arrow to add the selected tool at the bottom of the **Assigned Commands** list for the toolbar.
- 7) Use the up and down arrows in **Assigned Commands** to place the tool in its required position on the selected toolbar.
- 8) If necessary, insert a separator bar above the newly inserted tool as follows:
 - a) Select the newly inserted tool in the **Available Commands** list.
 - b) Click on **Insert** and select *Insert Separator* from the drop-down list.
- 9) If a separator bar needs to be removed, right-click on it and select *Remove* from the drop-down list.
- 10) If necessary, rename the newly inserted tool as follows:
 - a) Select the newly inserted tool in the **Available Commands** list.
 - b) Click on **Modify** and select *Rename* from the drop-down list.
 - c) Enter a new name for the tool in the Rename Menu dialog that opens.
 - d) Click **OK** to rename the tool and close the dialog.
- 11) Click **OK** to save the changes to the toolbar and close the Customize dialog.

Removing tools

- 1) Open the Customize dialog and click on **Toolbars** to open the **Toolbars** page.
- 2) In the **Scope** drop-down list, the LibreOffice module that is open appears as the selected module.
- 3) In the **Target** drop-down list, select the toolbar that has the tool that is going to be removed.
- 4) Select the tool for removal in the **Assigned Commands** list.

- 5) Click on the left arrow to move the selected tool into the **Available Commands** list and remove the tool from the selected toolbar.
- 6) Click **OK** to save the changes to the toolbar and close the Customize dialog.

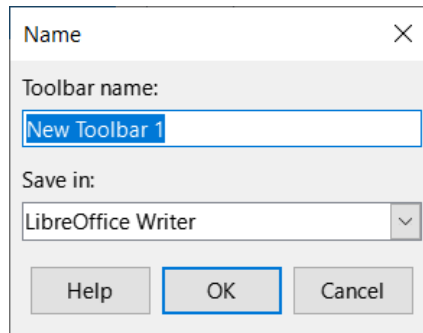

Figure 400: Name dialog

Creating new toolbars

- 1) Open the Customize dialog and click on **Toolbars** to open the **Toolbars** page.
- 2) In the **Scope** drop-down list, select the LibreOffice module displayed, or one of the listed documents.
- 3) Click on the three bars Ξ next to the **Target** drop-down list to open a context menu (Figure 397).
- 4) Select **Add** from the drop-down list to open the Name dialog (Figure 400).
- 5) Type a name for the new toolbar in the **Toolbar name** box.
- 6) In the **Save in** box select where to save the new toolbar. This can be a LibreOffice module, or one of the listed documents.
- 7) Click **OK** to save the new toolbar and close the Name dialog.
- 8) Add the required tools to the new toolbar. Refer to “Toolbar customization” on page 537 for information on how to add tools.
- 9) Click **OK** to save the new toolbar and close the Customize dialog.

Changing tool icons

Tools on a toolbar are indicated by icons and can be changed as follows:

- 1) Open the Customize dialog and click on **Toolbars** to open the **Toolbars** page.
- 2) In the **Target** drop-down list, select the toolbar where icons are going to be customized.
- 3) In **Assigned Commands**, select the tool where the icon is going to be changed.
- 4) Click on **Modify**, or right-click on the selected tool, and select **Change Icon** from the context menu to open the Change Icon dialog (Figure 401).
- 5) Select an icon from the available icons shown in the **Icons** preview box.
- 6) Click **OK** to change the icon for the selected tool and close the Change Icon dialog. There is no confirmation message when changing icons.
- 7) Click **OK** to save the changes to the toolbar and close the Customize dialog.

Note

Icons can be created using a graphics program and imported into LibreOffice. The recommended icon size is 16X16 pixels for best quality. Different sized icons are scaled automatically.

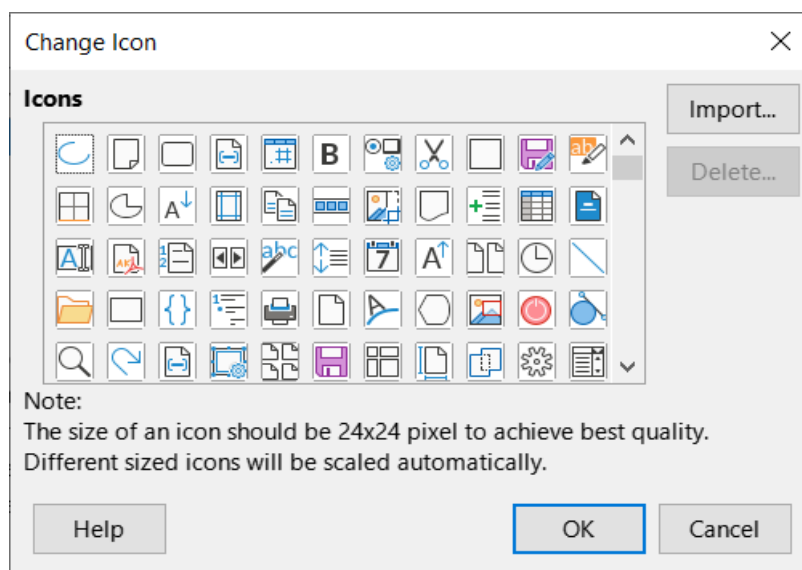

Figure 401: Change Icon dialog

Keyboard shortcuts

Using keyboard shortcuts

Many LibreOffice functions can be performed using keyboard shortcuts instead of a mouse. An example is *Ctrl+O* (macOS $\text{⌘}+O$) which is displayed next to the **Open** command in the **File** menu on the Menu bar. To use it, press and hold down the *Ctrl* (macOS ⌘) key and then press the *O* key to open the Open dialog. Release both keys after the Open dialog opens and displays. For more information on keyboard shortcuts, see Appendix A, Keyboard Shortcuts.

Creating keyboard shortcuts

Besides the keyboard shortcuts available in LibreOffice, custom keyboard shortcuts can be created. These can be allocated to LibreOffice functions or macros, and saved for use with the LibreOffice suite of applications.

Note

Some of the keyboard shortcuts available may be assigned as functions or commands for use by the computer system. Those assigned to the computer system should not be used as custom keyboard shortcuts within LibreOffice. It is possible to change those already assigned to the computer system, but is definitely NOT recommended. Changing the ones used by the computer system may create problems in the operation of a computer system.

1) Open the Customize dialog using one of following methods:

- Right-click in an empty space on a toolbar and select **Customize Toolbar** from the context menu.
- Go to **View > Toolbars > Customize** on the Menu bar.

- Go to **Tools > Customize** on the Menu bar and click on the **Toolbars** tab when the dialog opens.

2) Click on **Keyboard** to open the **Keyboard** page (Figure 402).

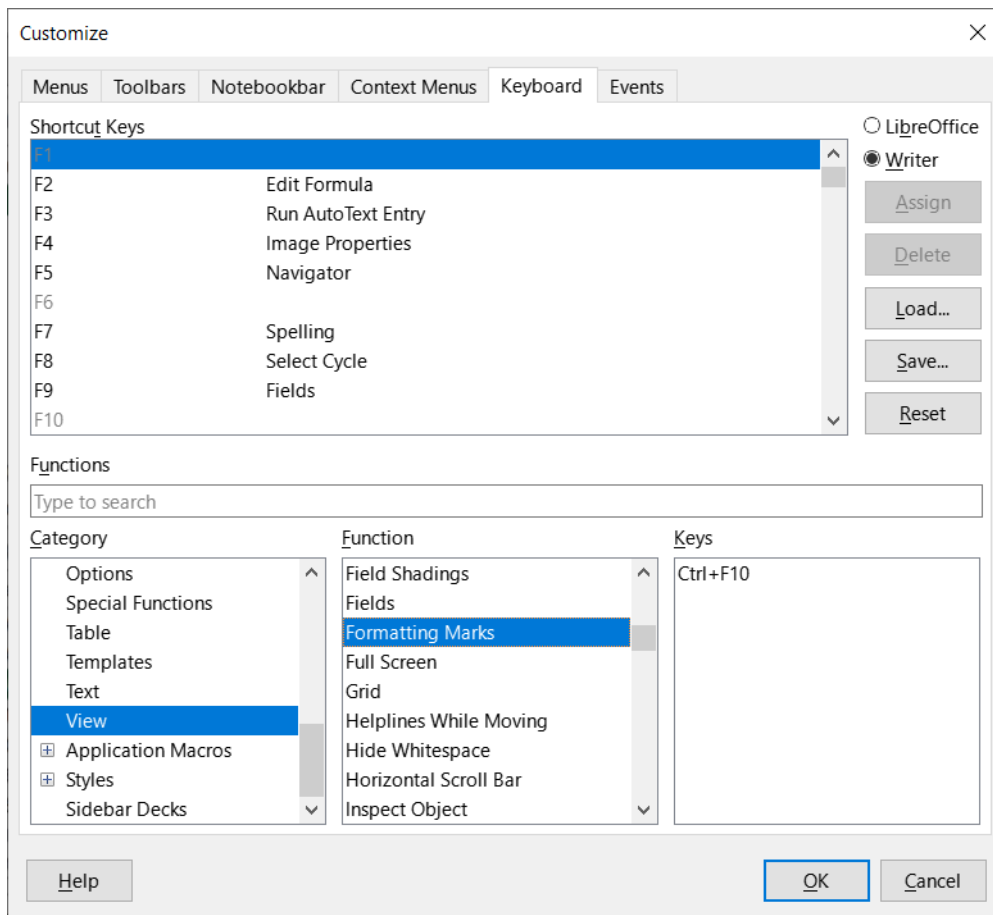

Figure 402: Customize dialog — Keyboard page

3) Assign a new keyboard shortcut to a command as follows:

- On the Keyboard page, find the shortcut available in all LibreOffice modules by selecting **LibreOffice** at the upper right of the dialog.
- Find the keyboard shortcut available in a selected LibreOffice module and select the LibreOffice module at the upper right of the dialog (Figure 402 shows that **Writer** has been selected).

4) Select the required category for the keyboard shortcut from the **Category** list.

5) Select the required function for the keyboard shortcut from the **Function** list.

6) Select the required shortcut key in the **Shortcut Keys** list and click on **Modify**. The selected shortcut key in **Shortcut Keys** is assigned to the selected **Category** and **Function**, and appears in **Keys**.

7) Click **OK** to save the new keyboard shortcut and close the Customize dialog.

Note

Any keyboard shortcut that is already assigned to a function appears in the **Keys** list. This is shown by the example of *Ctrl+F10* (macOS $\text{⌘}+F10$) in Figure 402 for the *View* category and *Formatting Marks* function. It is not recommended to change a keyboard shortcut that has already been assigned.

Any **Shortcut Keys** that are grayed-out in the list on the Customize dialog cannot be used or reassigned, for example *F1*, *F6*, and *F10*.

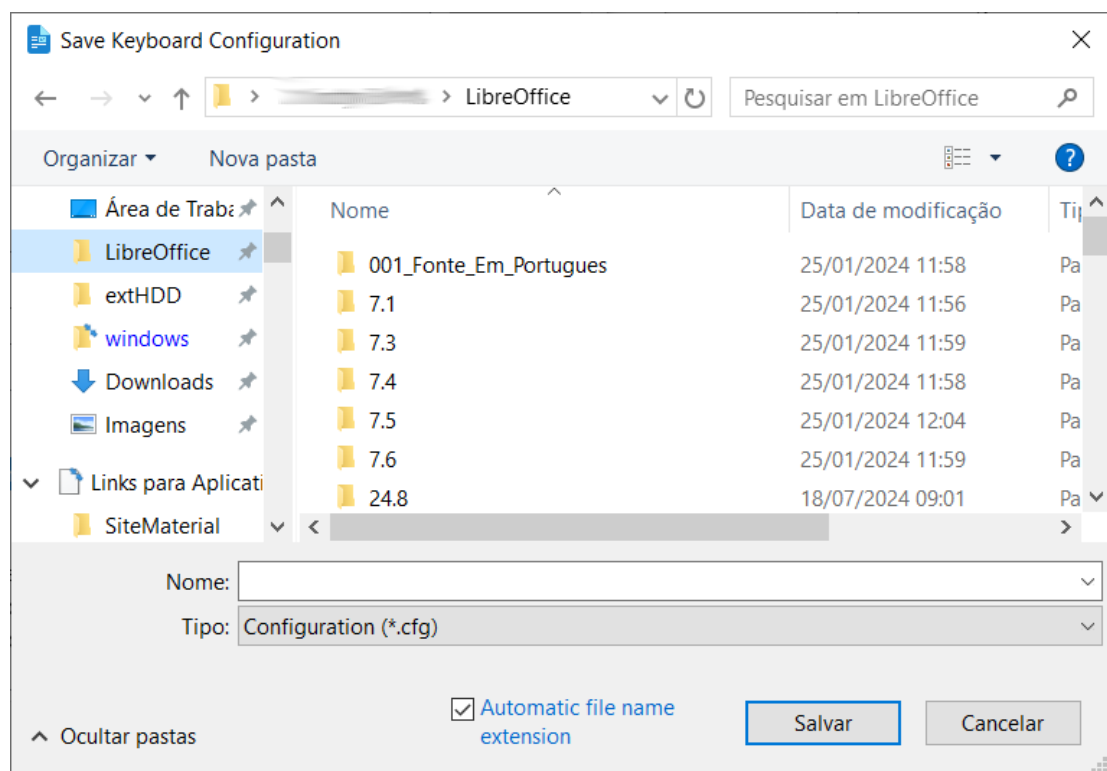

Figure 403: Example of Save Keyboard Configuration file browser

Saving keyboard configurations

Keyboard shortcut assignments can be saved as a configuration file. This allows the creation and application of different keyboard configurations whenever necessary. A keyboard configuration file can also be distributed among several users.

- 1) After making adjustments and changes to keyboard shortcut assignments, click on **Save** at the right side of the Customize dialog to open the file browser for Save Keyboard Configuration (example shown in Figure 403).
- 2) Navigate to the folder to be used for keyboard configuration files.
- 3) In the Save Keyboard Configuration file browser, enter a file name in the **File name** text box, or select a keyboard configuration file in the file list. The file name extension used for a keyboard configuration file is CFG, as shown by the example in the **File type** text box.
- 4) Click on **Save** to save the keyboard configuration file and close the Save Keyboard Configuration file browser.
- 5) Click **OK** to save the changes and close the Customize dialog.

Loading keyboard configurations

To load a saved keyboard configuration file and replace the existing keyboard configuration:

- 1) Click on **Load** at the right side of the Customize dialog to open the Load Keyboard Configuration file browser. This is similar to the Save Keyboard Configuration file browser.
- 2) Navigate to the folder where the keyboard configuration files are located.

- 3) Click on **Open** to load the selected keyboard configuration into LibreOffice and close the Load Keyboard Configuration file browser.
- 4) Click **OK** to save the changes and close the Customize dialog.
- 5) Restart LibreOffice to make sure the new keyboard configuration is active.

Resetting keyboard configuration

Resetting all of keyboard shortcuts to their default values in LibreOffice is as follows:

- 1) Open the Customize dialog using one of following methods:
 - Right-click in an empty space on a toolbar and select **Customize Toolbar** from the context menu.
 - Go to **View > Toolbars > Customize** on the Menu bar.
 - Go to **Tools > Customize** on the Menu bar and click on the **Toolbars** tab when the dialog opens.
- 2) Click on **Keyboard** to open the **Keyboard** page
- 3) Click on **Reset** at the right side of the Customize dialog. There is no confirmation dialog displayed when resetting a keyboard configuration to its default setting.
- 4) Click **OK** to save the changes and close the Customize dialog.
- 5) Restart LibreOffice to make sure the default keyboard configuration is active.

Assigning macros

Macros can be assigned to events in LibreOffice. The assigned macro automatically runs each time the associated event occurs. For example, an event could be when a document is opened, a key is pressed, or the cursor is moved. To associate a macro with an event, the **Events** page in the Customize dialog is used. For more information on assigning events to macros, see Chapter 11, Getting Started with Macros.

Adding extensions

An extension is a program that can be installed into LibreOffice to increase the functionality of LibreOffice. For example, templates, dictionaries, clip-art galleries, macros, and dialog libraries can be added to LibreOffice as extensions.

Several extensions are installed when LibreOffice is installed onto a computer. More extensions can be downloaded free of charge from the official extension repository located at <https://extensions.libreoffice.org/>.

Extensions can also be downloaded from other sources. Some of these extensions are free of charge; other extensions are available for a fee. Check the descriptions to see what licenses and fees apply to extensions from other sources.

Installing extensions

Installing an extension that is listed in the official extension repository can be done as follows:

- 1) Go to **Tools > Extensions** on the Menu bar to open the Extensions dialog (Figure 404).
- 2) Click on the **Get more extensions online** link. The official extension repository for LibreOffice opens in a web browser.

- 3) Enter a search term in the **What are you looking for?** text box in the web browser and click on **Search**.
- 4) If necessary, select a tag filter before searching to reduce the number of extensions in the search result.

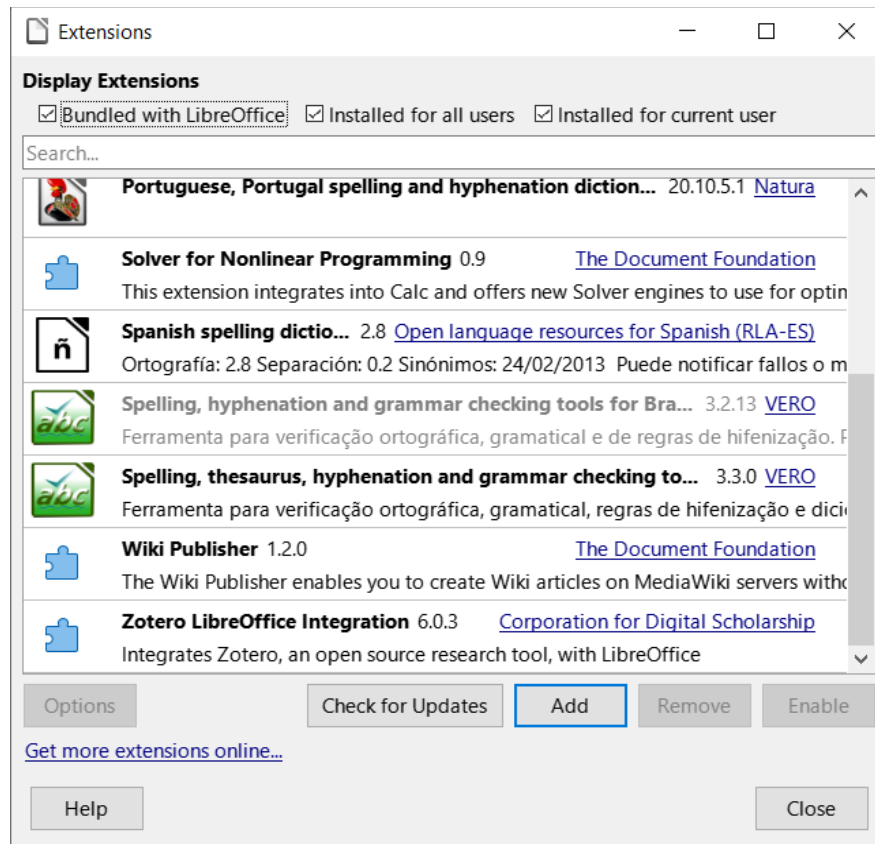

Figure 404: Extensions dialog

- 5) Locate the extension required and click on it to open the web page for the selected extension.
- 6) Check the extension description and its compatibility for the LibreOffice version and operating system being used.
- 7) For the correct extension version, click on **Download** and the extension will be downloaded into the Downloads folder (or any other you choose) on the computer.
- 8) In the Extensions dialog, click on **Add** to open the Add Extension(s) browser window.
- 9) Navigate to the folder where the extension is located.
- 10) Select the extension and click on **Open**.
- 11) If necessary, accept the license agreement and the extension will be installed and listed in the Extensions dialog.
- 12) If necessary, restart LibreOffice for the extension to become effective.

Note

To install an extension that is not listed in the official extension repository, download the extension from its source, then continue from Step 7 above to install the extension.

Updating extensions

It is necessary to check for updates to extensions on a regular basis. Checking for extension updates is as follows:

- 1) Go to **Tools > Extensions** on the Menu bar to open the Extensions dialog.
- 2) Click on **Check for Updates** to open the Extension Update dialog.
- 3) Select any extension that is listed in **Available extension updates** and click on **Install** to update the extension.
- 4) Close the Extension Update and Extensions dialogs.
- 5) If necessary, restart LibreOffice for the extension update to become effective.

Removing extensions

To remove and completely uninstall an extension no longer required do as follows:

- 1) Go to **Tools > Extensions** on the Menu bar to open the Extensions dialog.
- 2) Select the extension for removal in the Extensions dialog.
- 3) Click on **Remove** and confirm the removal of the extension.
- 4) Close the Extensions dialog.

Disabling extensions

To disable an extension without removing the extension from LibreOffice do as follows:

- 1) Go to **Tools > Extensions** on the Menu bar to open the Extensions dialog.
- 2) Select the extension being disabled in the Extensions dialog.
- 3) Click on **Disable**. The **Disable** button changes to **Enable**.
- 4) When necessary, click on **Enable** and the extension can be used again in LibreOffice.
- 5) Close the Extensions dialog.

Note

If **Remove** and **Disable** are grayed out in the Extensions dialog, the extension cannot be removed or disabled. For example, when an extension is part of the LibreOffice installation, it cannot, or must not, be removed or disabled.

Creating custom colors

Custom colors can be created and added to the LibreOffice custom palette. For example, custom colors may be required to exactly match a corporate color scheme when creating documents. Custom colors are created by changing the values in one of the following color notations.

- RGB notation of Red (R), Green (G), and Blue (B)
- Hex # number
- Hue (H), Saturation (S), and Brightness (B)
- CMYK percentages of Cyan (C), Magenta (M), Yellow (Y), and Black (K).

The following procedures for creating custom colors are examples of creating a color area fill for an object. Custom colors created for area fills are saved into the Custom palette, making custom colors available for use with lines, arrows, or text. The dialogs that can be used to create custom colors are as follows:

- Pick A Color dialog.
- **The Color** page in the Area dialog.
- **The Line** page in the Line dialog.
- **Font Color** on the **Font Effects** page in the Character, or Character Style dialog.
- **Font Color** on the **Font Effects** page in the Paragraph Style dialog.
- **Fill Color** in the **Area** panel in the Properties deck on the Sidebar.
- **Line Color** in the **Line** panel in the Properties deck on the Sidebar.
- **Font Color** in the **Character** panel in the Properties deck on the Sidebar.

Using Area dialog for objects

- 1) Insert a filled object into a document, for example a square, and make sure it is selected.
- 2) Right-click on the selected object and select **Area** from the context menu to open the Area dialog (Figure 405).

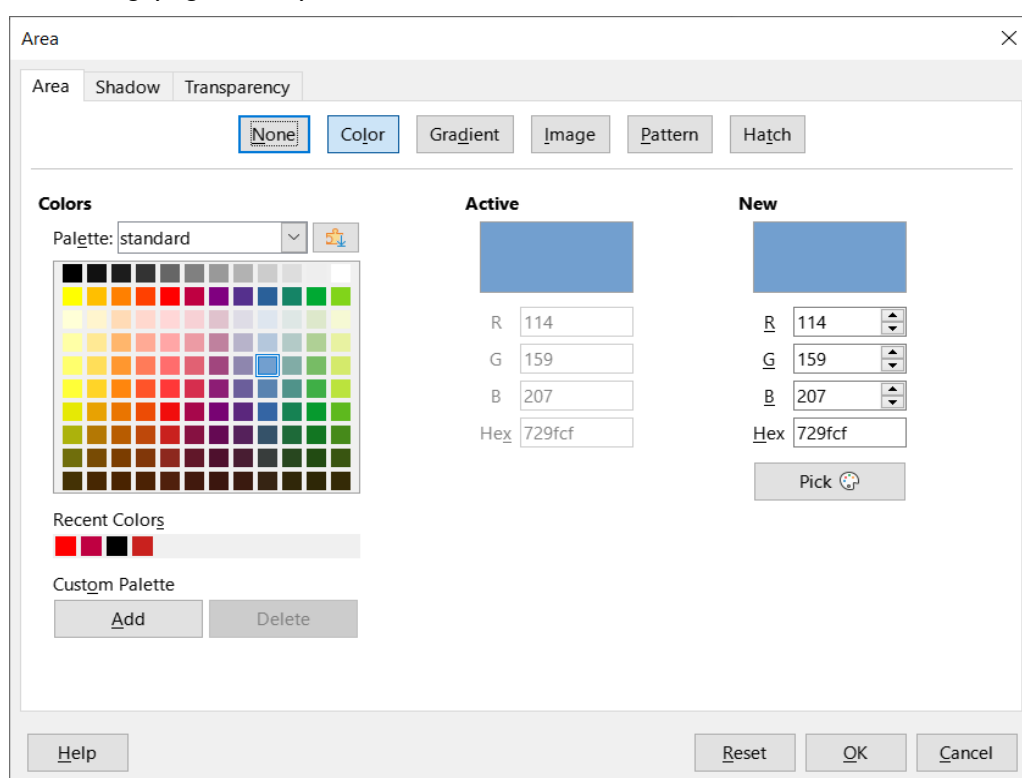

Figure 405: Area dialog — Color page

- 3) Click on **Color** to open the options available for a color fill.
- 4) Specify the values in **New** for Red (R), Green (G), and Blue (B) on a 0 to 255 scale, or enter the Hex # number for the custom color, if known.
- 5) Click on **Add** in *Custom Palette* and enter a name for the color in the Name dialog that opens.
- 6) Click **OK** to close the Name dialog and the color is added to the *Custom* palette.

- 7) Click **OK** to close the Area dialog and save the changes. The new custom color appears as a fill in the selected object and is available for use in other documents.

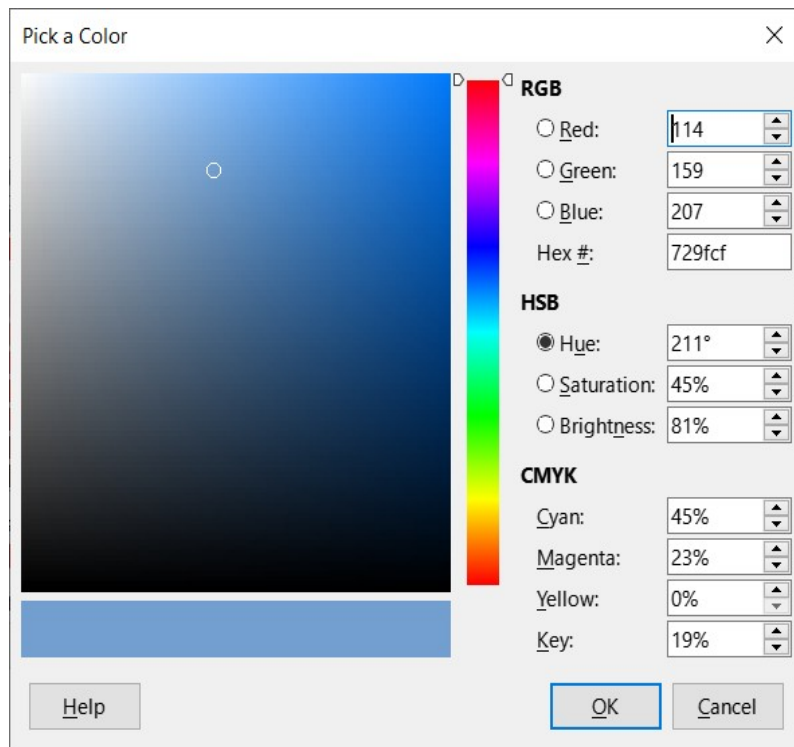

Figure 406: Pick A Color dialog

Note

The color notations are linked and changing the value in one notification set automatically changes the values in the other notification sets.

Using Pick a Color dialog for objects

- 1) Insert a filled object into a document, for example a square, and make sure it is selected.
- 2) Open the Pick a Color dialog (Figure 406) using one of the following methods:
 - Click on the **Pick** button on the **Color** page of the Area dialog.
 - Click on the triangle ▼ next to **Fill Color** on the Line and Filling toolbar and select Custom Color from the context menu.
 - Click on the triangle ▼ next to **Fill Color** in the Area panel of the Properties deck on the Sidebar and select **Custom Color** from the context menu.
- 3) To create a custom color, there are three ways to do it. Note that a preview of the color being created is shown on the left side of the original color box below the color selection box while changes are made.
 - Select a color range from the colored bar, then, using the cursor, move the target in the colored box until the cursor is on the color desired.
 - Enter values for Red (R), Green (G), and Blue (B) in the **RGB** text boxes.
 - Enter values for Cyan (C), Magenta (M), Yellow (Y), and Key (K) (black) in the **CMYK** text boxes.
 - Enter values for Hue (H), Saturation (S), and Brightness (B) in the **HSB** text boxes. Saturation and brightness values do not change the color itself (hue), but how it looks.

- If known, enter the *Hex #* number in the text box. Hex numbers are normally used when a specific color has been created for a company logo or company name.
- 4) Click **OK** to close the Pick a Color dialog and save the color. The color appears as a fill in the selected object.
- 5) Open the **Color** page of the Area dialog.
- 6) Click on **Add** in *Custom Palette* and enter a name for the color in the Name dialog that opens.
- 7) Click **OK** to close the Name dialog and the color is added to the *Custom* palette.
- 8) Click **OK** to close the Area dialog. The new color is now available for use in other documents.

Adding fonts

LibreOffice supports the PostScript (.pfb), TrueType (.ttf), and OpenType (.otf) font file formats. Other font formats are available and may be supported by the operating system. However, these font formats may be limited in character selection and quality.

Administration privileges are required to install additional fonts. After installation onto an operating system, any additional fonts are available for use by all modules in LibreOffice.

In addition to proprietary fonts from sources like Adobe, hundreds of free license fonts are available. Most free license fonts are available at no cost and can be used, shared, and edited. Many of these fonts are clones, or close variations of classic fonts, but several fonts are original.

Many Linux distributions include some free license fonts in their package repositories. There are several places where free licenses are available, such as The League of Movable Type (<https://www.theleagueofmoveabletype.com>), or the Open Font Library (<https://fontlibrary.org>).

User interface variants

By default, commands and functions in LibreOffice are grouped in cascading menus with tools available on toolbars, called the Standard Toolbar user interface. Other user interface variants, are available, displaying contextual groups of commands and contents. With each LibreOffice module having different requirements, refer to the specific user guide for each LibreOffice module for a full description of user interface variants and how to use the user interface.

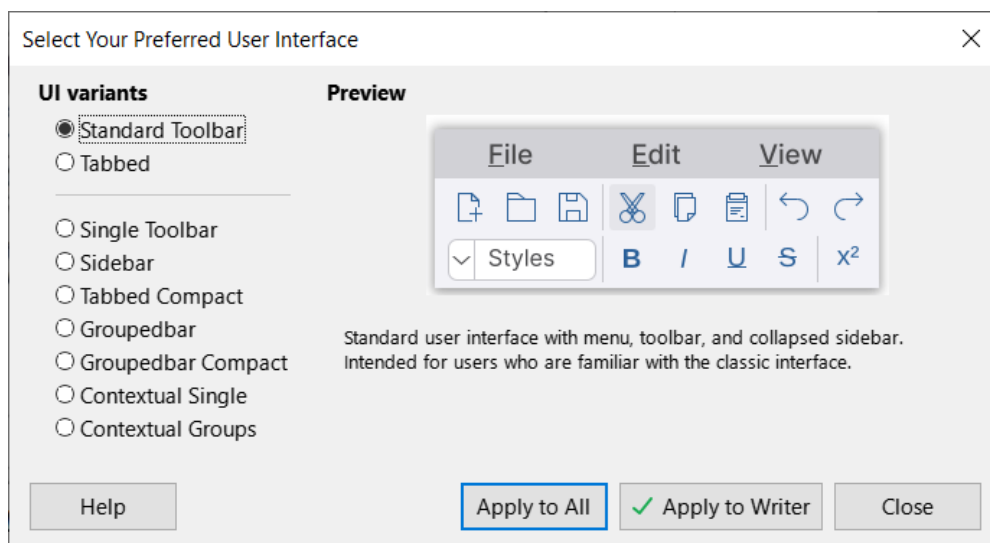

Figure 407: Select Your Preferred User Interface dialog

Select a preferred user interface variant as follows:

- 1) Open a LibreOffice module to change the user interface.
- 2) Go to **View > User Interface** on the Menu bar to open the Select Your Preferred User Interface dialog (Figure 407).
- 3) Select the preferred user interface from the options available in **UI variants**. A preview of the selected user interface is displayed in the dialog.
- 4) To use the selected user interface for all LibreOffice modules, click on **Apply to All**.
- 5) To only use the selected user interface for the LibreOffice module that is open, click on **Apply to {Module}**, for example **Apply to Writer**.
- 6) Click on **Close** to close the dialog.



LibreOffice
Community



Appendix A, Keyboard Shortcuts

Introduction

LibreOffice can be used without requiring a pointing device, such as a mouse or trackball, by using the keyboard shortcuts that are available in Draw. Tasks as varied and complex as docking and un-docking toolbars and windows, or changing the size or position of objects can all be accomplished with using keyboard shortcuts. Although LibreOffice has an extensive set of keyboard shortcuts, each LibreOffice module has keyboard shortcuts that are specific to that module.

This appendix lists some of the more common keyboard shortcuts that apply to multiple components of LibreOffice. For shortcuts specific to Writer, Calc, Impress, Draw, Math, or Base, refer to the relevant user guide for each module, or search the LibreOffice Help.

To assist a user with identifying keyboard shortcuts, these are indicated by text next to menu items and in tooltips for some tools on toolbars. For example, in Writer some commonly used keyboard shortcuts are as follows:

- **File > Open** on the Menu bar includes text indicating that *Ctrl+O* (macOS $\text{⌘}+O$) is a keyboard shortcut.
- **Align Left** tool in the Formatting toolbar has a tooltip indicating that *Ctrl+L* (macOS $\text{⌘}+L$) is a keyboard shortcut.

A list of available keyboard shortcuts in LibreOffice can be found in the keyboard tab of the Customize dialog box. Go to **Tools > Customize** on the Menu bar and click on **Keyboard** section to open the **Keyboard** tab. Examples of keyboard shortcuts for Linux/Windows see Figure 408 and for macOS see Figure 409.

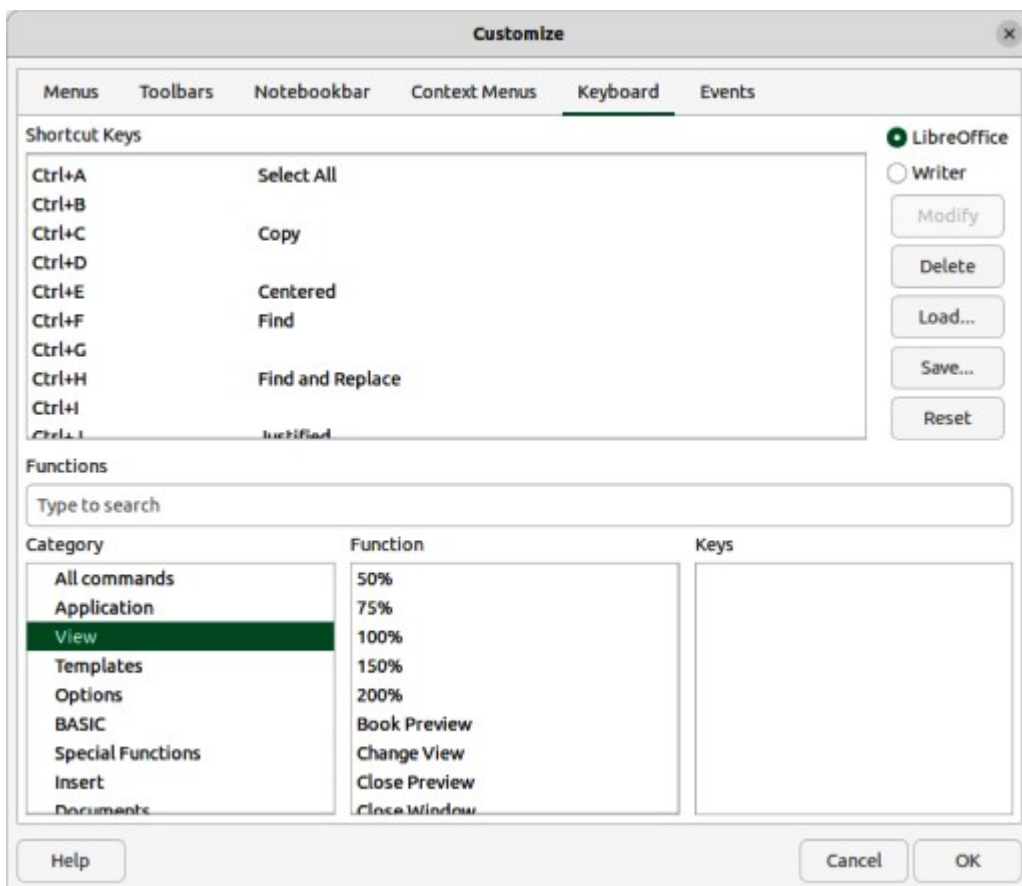

Figure 408: Customize dialog — Keyboard tab for Linux/Windows

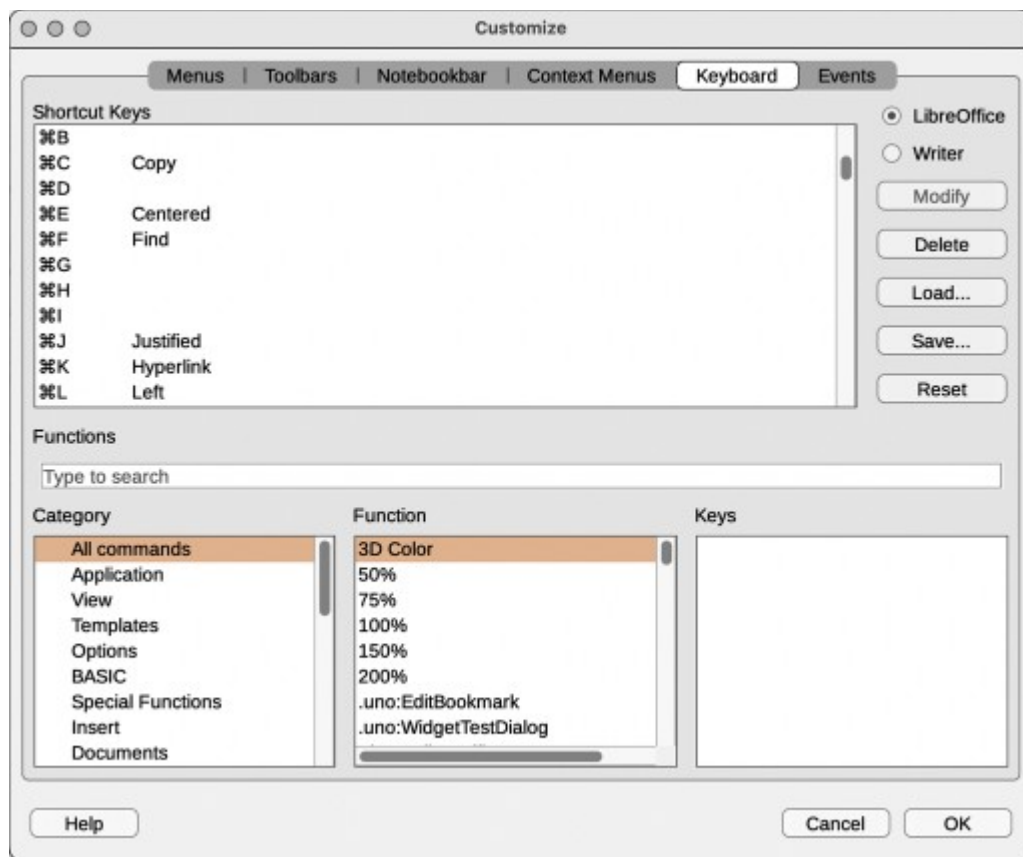

Figure 409: Customize dialog — Keyboard tab for macOS

Note

Some keyboard shortcuts listed may not be available, if the computer operating system uses the same shortcuts as LibreOffice for other tasks. To solve any conflicts, assign different keys to these shortcuts by reconfiguring either LibreOffice (see Chapter 13, Customizing LibreOffice), or the computer operating system (see operating system documentation or help).

LibreOffice assistive tools

In addition to keyboard shortcuts, LibreOffice supports some assistive technology tools like screen magnification software, screen readers, and on-screen keyboards. Please note that except for the Windows platform, accessibility support relies on Java technology for communication with assistive technology tools. This means that the first program startup may take a few seconds longer, because the Java runtime environment has to be started as well.

The current list of supported assistive tools can be found at <https://wiki.documentfoundation.org/Accessibility>.

macOS keyboard shortcuts

Some keystrokes and menu items are different on a macOS computer from those used in Windows or Linux computers. This due to the way the different systems work and the different types of keyboards used. Also, the labeling on keyboards may vary depending on the age of the computer and style of keyboard being used.

Tables 21, 22 and 23 show the most common variations in keyboard shortcuts and keyboard labeling. Table 24 shows examples of using macOS keyboard shortcuts. For more information on keyboard shortcuts, see LibreOffice Help.

Table 21: Shift, Control and Alt keys

Windows or Linux	macOS
Control or Ctrl	⌘ or Cmd or Command
Alt	⌥ or Option or Alt
Shift or ⇧	Shift or ⇧
Caps Lock	⌵ or Caps Lock
Control or Ctrl	^ or Control or Ctrl

Table 22: Home and End keys

Windows or Linux	macOS
Home	Fn+Left Arrow
End	Fn+Right Arrow

Table 23: Page Up and Page Down

Windows or Linux	macOS
Screen Up	Fn+Up Arrow
Page Up	⌥ or Option or Alt+Fn+Up Arrow
Screen Down	Fn+Down Arrow
Page Down	⌥ or Option or Alt+Fn+Down Arrow

Table 24: Example of using macOS keyboard shortcuts

Windows or Linux	macOS equivalent	Effect
Tools > Options	LibreOffice > Preferences	Access setup options
Right-click	Control+click or right-click depending on computer setup	Opens a context menu
Ctrl (Control)	⌘ (Command)	Used with other keys
Alt	⌥ (Option) or Alt, depending on keyboard	Used with other keys
F11	⌘+T	Open Styles deck in Sidebar

 **Note**
 Actual keys available on a macOS keyboard depend on the type of keyboard being used. For example, a macOS laptop keyboard does not have the *Delete* key, but a macOS keyboard with a numeric keypad does have this key.

Keyboard shortcuts

 **Note**
 In computers using macOS, some keyboard shortcuts are not available and these unavailable keyboard shortcuts are indicated in the following tables with a blank cell. Some of the shortcut keys may be assigned to the computer operating system and are not available for LibreOffice. Either assign different keys in LibreOffice using **Tools > Customize > Keyboard** on the Menu bar, or in the computer operating

system. For more information, see Chapter 13, Customizing LibreOffice or the documentation/help for the computer operating system.

Using keyboard shortcuts

LibreOffice functions can be used by using keyboard shortcuts. For example, the *Ctrl+O* (macOS $\text{⌘}+O$) shortcut is shown next to **Open** in the **File** menu on the Menu bar. To use it, press and hold down the *Ctrl* (macOS ⌘) key and then press the *O* key. Release both keys together after the dialog opens.

Opening menus and menu items

Table 25: Keyboard shortcuts for opening menus and menu items

Windows Linux	macOS	Effect
<i>Alt+<?></i> (Windows only)		Opens a menu where <?> is an underlined character of the menu being opened. For example, <i>Alt+F</i> opens the File menu. When a menu is opened, there may be sub-menu items with underlined characters. Press the underlined character directly to carry out the action or option. Where two menu items have the same underlined character, press the character key again to move to the next menu item. Menu items that have no underlined character have to be clicked on directly.
<i>Esc</i>	<i>Esc</i>	Closes an open menu.
<i>F6</i>		Repeatedly pressing <i>F6</i> switches the focus through the following objects: Menu bar. Every toolbar from top to bottom and from left to right. Every free window from left to right. Document.
	<i>F6</i>	Repeatedly pressing <i>F6</i> switches the focus through the following objects: Each toolbar from top to bottom and from left to right. Sidebar. Document.
<i>Shift+F6</i>	<i>Shift+F6</i>	Switches focus through objects in the opposite direction.
<i>Ctrl+F6</i>	$\text{⌘}+F6$	Switches the focus to the document.
<i>F10</i>		Switches focus to the Menu bar and back.

Accessing menu commands

- 1) Press *Alt*, *F6*, or *F10* to select the first item of the Menu bar (normally the **File** menu). In macOS, selection is the first tool on the Standard toolbar and this tool is normally **New**.
- 2) Press the right, or left arrow, to move the selection right, or left.
- 3) Press the *Home* key (macOS *Fn+left arrow*) or *End* key (macOS *Fn+right arrow*) to move menu selection to the first or last item on the Menu bar.

- 4) Press the down, or up arrow, to move the selection down, or up, the list of menu commands.
- 5) If necessary, press the right arrow to open any sub-menus on the selected menu. Sub-menus are indicated by a triangle ► or chevron > next to the name of a selected menu item.
- 6) If necessary, press the down, or up, arrow to move the selection down or up the list of sub-menu commands.
- 7) If necessary, press the left arrow to close a sub-menu.
- 8) Press *Enter* to run the selected menu, or sub-menu command.

Accessing toolbar commands

- 1) Press *F6* repeatedly until the first icon on a toolbar is selected.
- 2) On a horizontal toolbar, press the right or left arrows to move tool selection to the right or left.
- 3) On a vertical toolbar, press the up or down arrows to move tool selection upward or downward.
- 4) Press the *Home* key (macOS *Fn+left arrow*) or *End* key (macOS *Fn+right arrow*) to move tool selection to the first or last tool on a toolbar.
- 5) Press *Enter* to action the selected tool on the toolbar.
- 6) To insert an object into a drawing or presentation after selecting the required object on the Drawing toolbar, use the key combination *Ctrl+Enter* (macOS *⌘+Enter*) to insert the object in the center of the drawing page or slide.





Note







If a tool on a toolbar has an editable text field, for example **Load URL** or **Line Width**, the *Tab* or *Shift+Tab* keys are then used to move the selection right or left onto the next tool on the toolbar.

Navigation

Navigate through a document using keyboard shortcuts as shown in Table 26.



Table 26: Keyboard shortcuts for navigation

Windows Linux	macOS	Effect
<i>Left Arrow</i>	<i>Left Arrow</i>	Moves the cursor one character to the left.
<i>Shift+Left Arrow</i>	<i>Shift+Left Arrow</i>	Moves the cursor one character to the left and selects the character.
<i>Ctrl+Left Arrow</i>	 + <i>Left Arrow</i>	Moves the cursor to the beginning of the previous word.
<i>Right Arrow</i>	<i>Right Arrow</i>	Moves the cursor one character to the right.
<i>Shift+Right Arrow</i>	<i>Shift+Right Arrow</i>	Moves the cursor one character to the right and selects the character.
<i>Ctrl+Right Arrow</i>	 + <i>Right Arrow</i>	Moves the cursor to the beginning of the next word.
<i>Up Arrow</i>	<i>Up Arrow</i>	Moves the cursor up one line.
<i>Shift+Up Arrow</i>	<i>Shift+Up Arrow</i>	Moves the cursor up one line in the text and selects the lines of text.

Windows Linux	macOS	Effect
<i>Ctrl+Up Arrow</i>	 + <i>Up Arrow</i>	Moves the cursor to the beginning of the paragraph.
<i>Down Arrow</i>	<i>Down Arrow</i>	Moves the cursor down one line.
<i>Ctrl+Down Arrow</i>	 + <i>Down Arrow</i>	Moves the cursor to the end of the paragraph.
<i>Ctrl+Shift+Down Arrow</i>	 + <i>Shift+Down Arrow</i>	Moves the cursor to the end of the paragraph. Selects the text in the paragraph from the cursor position to the end of the paragraph.
<i>Home</i>	<i>Fn+Left Arrow</i> or <i>Ctrl+A</i>	Moves the cursor to the beginning of the current line.
<i>Shift+Home</i>		Moves the cursor to the beginning of the line and selects the text from the cursor position.
<i>Ctrl+Home</i>	 + <i>Up Arrow</i>	Moves the cursor to the beginning of the document.
<i>End</i>	<i>Fn+Right Arrow</i> or <i>Ctrl+E</i>	Moves the cursor to the end of the current line.
<i>Shift+End</i>		Moves the cursor to the end of the line and selects the text from the cursor position.
<i>Ctrl+End</i>	 + <i>Down Arrow</i>	Moves the cursor to the end of the document.
<i>Page Up</i>	<i>Fn+Up Arrow</i>	Scrolls up one page.
<i>Ctrl+Page Up</i>	 + <i>Fn+Up Arrow</i>	Moves the cursor to the header.
<i>Page Down</i>	<i>Fn+Down Arrow</i>	Scrolls down one page.
<i>Ctrl+Page Down</i>	 + <i>Fn+Down Arrow</i>	Moves the cursor to the footer.

Text selection and deletion

Select and delete text using keyboard shortcuts as follows:

- Select text while moving the cursor, hold down the *Shift* key as the cursor is moved.
- Double-click on a word with the cursor to select the word.
- Triple-click in a sentence with the cursor to select the whole of the sentence.
- Click four times in a paragraph with the cursor to select the whole of the paragraph.
- Select all of the text or objects in a document, use *Ctrl+A* (macOS +A).
- Use *Ctrl+Delete* to delete everything from the cursor position to the end of the word.
- Use *Ctrl+Backspace* to delete everything from the cursor position to the beginning of the word.
- For macOS, use +*Delete* (if the keyboard has a *Delete* key) to delete everything from the cursor position to the end of the word.
- For macOS, use +*Backspace* to delete everything from the cursor position to the beginning of the line.

Controlling dialogs

When opening any dialog, one element or option is highlighted indicating that the element or option has focus on it. For example, a button, option field, entry in a list box, or checkbox. How the element or option is highlighted depends on the computer operating system and how the computer is setup.











Table 27: Keyboard shortcuts for controlling dialogs

Shortcut Keys	Result
<i>Enter</i>	Activates selected button. When no button is selected, <i>Enter</i> is equivalent to clicking OK .
<i>Esc</i>	Closes dialog without saving any changes made while the dialog was open. <i>Esc</i> is also equivalent to clicking Cancel . When a drop-down list is open and selected, <i>Esc</i> closes the list.
<i>Spacebar</i>	Checks or clears an empty checkbox.
<i>Up or Down Arrow</i>	Moves focus up or down a list. Increases or decreases value of a variable. Moves focus vertically within a section of dialog.
<i>Left or Right Arrow</i>	Moves focus horizontally within a section of a dialog.
<i>Tab</i>	Advances focus to the next section or element of a dialog.
<i>Shift+Tab</i>	Returns focus to the previous section or element in a dialog.
<i>Alt+Down Arrow</i> (macOS  +Down Arrow)	Shows items in a drop-down list.

Controlling documents and windows

The keyboard shortcuts for controlling documents and windows in LibreOffice are shown in Table 28.

Table 28: Keyboard shortcuts for controlling documents and windows

Windows Linux	macOS	Effect
<i>Ctrl+O</i>	 +O	Opens the Open dialog to select and open a document.
<i>Ctrl+S</i>	 +S	Saves the current document. If the document is a previously unsaved file, the shortcut opens the Save As dialog.
<i>Ctrl+N</i>	 +N	Creates a new document.
<i>Shift+Ctrl+N</i>	 +Shift+N	Opens the Templates dialog.
<i>Ctrl+P</i>	 +P	Opens the Print dialog to print the document.
<i>Ctrl+F</i>	 +F	Opens the Find toolbar.
<i>Ctrl+H</i>	 +  +F	Opens the Find and Replace dialog.
<i>Ctrl+Shift+F</i>		Searches for the last entered search term.
<i>Ctrl+Shift+J</i>		Toggles the view between full-screen mode and normal mode in Writer or Calc.
<i>Ctrl+Shift+R</i>	 +Shift+R	Opens and closes the rulers.
<i>F1</i>	<i>F1</i>	Opens the LibreOffice Help contents in your default browser. If the local Help package is not installed, LibreOffice opens the online Help located at https://help.libreoffice.org .
<i>Shift+F1</i>	<i>Shift+F1</i>	Turns the cursor into a What's This? question mark. Shows the tip for an item underneath the cursor. The shortcut does not work with the online help.
<i>Shift+F2</i>	<i>Shift+F2</i>	Turns on Extended Tips for the currently selected command, icon or control. The shortcut does not work with the online help.
<i>Ctrl+Shift+F10</i>	 +Shift+F10	Docks and undocks floating toolbars, Sidebar and Navigator.

Windows Linux	macOS	Effect
<i>Ctrl+F4</i> or <i>Alt+F4</i>	⌘+F4	Closes the current document. Closes LibreOffice when the last open document is closed.
<i>Ctrl+Q</i>	⌘+Q	Exits LibreOffice.

Editing or formatting documents

The keyboard shortcuts for editing and formatting documents in LibreOffice are shown in Table 29.

Table 29: Keyboard shortcuts for editing and formatting documents

Windows Linux	macOS	Effect
<i>Enter</i>	<i>Enter</i>	When an OLE object is selected, activates the software used to create the OLE object. When a drawing object is selected, activates text mode.
<i>Ctrl+X</i>	⌘+X	Cuts selected text or objects from a document and places them in the clipboard.
<i>Ctrl+C</i>	⌘+C	Copies selected text or objects and places them in the clipboard.
<i>Ctrl+V</i>	⌘+V	Places text or objects from the clipboard that have copied or cut into the document.
<i>Ctrl+Alt+ Shift+V</i>	⌘+⇧+Shift+V	Pastes unformatted text from the clipboard. The text is pasted using the format that exists at the insertion point.
<i>Ctrl+Shift+V</i>	⌘+Shift+V	Opens the Paste Special dialog.
<i>Ctrl+A</i>	⌘+A	Selects all text and objects in a document.
<i>Ctrl+Z</i>	⌘+Z	Undoes last action.
<i>Ctrl+Y</i>	⌘+Y	Redoes last action.
<i>Ctrl+Shift+Y</i>	⌘+Shift+Y	Repeats last command.
<i>Ctrl+I</i>	⌘+I	Applies the Italic attribute to selected characters and text.
<i>Ctrl+B</i>	⌘+B	Applies the Bold attribute to selected characters and text.
<i>Ctrl+U</i>	⌘+U	Applies the Underline attribute to selected characters and text.
<i>Ctrl+M</i>	⌘+M	Removes direct formatting from selected text or objects. This command is also available in Format > Clear Direct Formatting in the Menu bar.

Sidebar keyboard shortcuts

General

The general keyboard shortcuts for using the Sidebar in LibreOffice are shown in Table 30.

Table 30: General keyboard shortcuts for Sidebar



Windows Linux	macOS	Effect
<i>Tab</i>	<i>Tab</i>	Moves the focus in the Sidebar.
<i>Shift+Tab</i>	<i>Shift+Tab</i>	Moves the focus in the reverse direction in the Sidebar.

Windows Linux	macOS	Effect
<i>Shift+F10</i>	<i>Shift+F10</i>	Opens a context menu for the selected element in the Sidebar.
<i>Home</i>	<i>Fn+Left Arrow</i>	Moves focus to first entry.
<i>End</i>	<i>Fn+Right Arrow</i>	Moves focus to last entry.
<i>Up or Down Arrow</i>	<i>Up or Down Arrow</i>	Moves the selection up or down and opens the panels in the selected deck.
<i>Right Arrow</i>	<i>Right Arrow</i>	Opens any sub-elements in the selected element.
<i>Left Arrow</i>	<i>Left Arrow</i>	Closes any sub-elements in the selected element.
<i>Ctrl+Enter</i>	 +Enter	Opens the Properties dialog for the selected element.

Gallery

The keyboard shortcuts for the Gallery on the Sidebar in LibreOffice are shown in Table 31.







Table 31: Keyboard shortcuts for the Gallery

Windows Linux	macOS	Effect
<i>Ctrl+R</i>		Opens the Enter Title dialog. Only themes added to LibreOffice can be renamed. Themes installed with LibreOffice cannot be renamed.
<i>Ctrl+D</i>	 +D	Deletes themes that have been added to LibreOffice. Themes installed with LibreOffice cannot be deleted.
<i>Insert</i>		Inserts a new theme into the Gallery and opens the Insert of New Theme dialog.
<i>Ctrl+Shift+Insert</i>	 +Shift+Insert	Inserts the selected object as a linked object into the current document.
<i>Ctrl+I</i>	<i>Ctrl+I</i>	Inserts a copy of the selected object into the current document.
<i>Ctrl+P Spacebar Enter</i>	<i>Ctrl+P Spacebar Enter</i>	Switches between a view of a list of object previews and a selected object.

Database table keyboard shortcuts

The keyboard shortcuts for using a database table in LibreOffice are shown in Table 32.



Table 32: Keyboard shortcuts for a database table

Windows Linux	macOS	Effect
<i>Ctrl+Shift+F4</i>	 +Shift+F4	Opens and closes a database table in a document for editing.
<i>Spacebar</i>	<i>Spacebar</i>	Toggles row selection, except when the row is in edit mode.
<i>Ctrl+Spacebar</i>	 +Spacebar	Toggles row selection.
<i>Shift+Spacebar</i>	<i>Shift+Spacebar</i>	Selects the current column.
<i>Ctrl+Page Up</i>	 +  + Fn+Up Arrow	Moves the cursor to the first row.
<i>Ctrl+Page Down</i>	 +  + Fn+Down Arrow	Moves the cursor to the last row.





Controlling macros

Keyboard shortcuts for controlling macros in LibreOffice are shown in Table 33. For more information on macros, see Chapter 11, Getting Started with Macros.



Table 33: Keyboard shortcuts for controlling macros

Windows Linux	macOS	Effect
<i>Ctrl</i> +*	 +*	Runs a macro field. The multiplication sign is only available on a numeric keypad.
<i>Shift</i> + <i>Ctrl</i> +Q	 + <i>Ctrl</i> +Q	Stops a running macro.

Entering Unicode numbers

Each character in LibreOffice can be entered into a document by typing its Unicode hexadecimal number and then the keyboard shortcut *Ctrl*+*Alt*+*X* (mac OS ++*X*) to create it. For example, to enter the copyright sign into text, type *U+00A9* followed immediately by *Ctrl*+*Alt*+*X* (mac OS ++*X*) and the copyright sign © appears at the cursor position in the text.

Note

Unicode hexadecimal numbers in the range *U+0000* to *U+0020* are not converted into characters using the keyboard shortcut *Ctrl*+*Alt*+*X* (mac OS ++*X*).

Defining keyboard shortcuts

In addition to using the built-in keyboard shortcuts listed in this Appendix, custom keyboard shortcuts can also be defined. For more information, see Chapter 13, Customizing LibreOffice.

To check if a keyboard shortcut is already in use, open the Keyboard page in the Customize dialog and scroll through the listed keyboard shortcuts. Go to **Tools > Customize** on the Menu bar to open the Customize dialog.

Further reading

For help with keyboard shortcuts, or to use LibreOffice with a keyboard only, search LibreOffice Help using the keywords “shortcut keys” or “accessibility”.



*Appendix B,
Open Source, Open
Standards, OpenDocument*

Introduction

LibreOffice is a productivity suite that is compatible with other major office suites and available on a variety of platforms. It is open source software and therefore free to download, use, and distribute. If you are new to LibreOffice, this appendix will provide some information regarding its history, its community, and some of its technical specifications.

A short history of LibreOffice

The OpenOffice.org project began when Sun Microsystems released the source code (“blueprints”) for its StarOffice® software to the open source community on 13 October 2000. OpenOffice.org 1.0, the product, was released on 30 April 2002. Major updates to OpenOffice.org included version 2.0 in October 2005 and version 3.0 in October 2008. On 26 January 2010, Oracle Corporation acquired Sun Microsystems.

On 28 September 2010, the community of volunteers who develop and promote OpenOffice.org announced a major change in project structure. After ten years of successful growth with Sun Microsystems as founding and principle sponsor, the project launched an independent foundation called The Document Foundation, to fulfill the promise of independence written in the original charter. This foundation is the cornerstone of a new ecosystem where individuals and organizations can contribute to and benefit from the availability of a truly free office suite.

Unable to acquire the trademarked OpenOffice.org name from Oracle Corporation, The Document Foundation named its product as LibreOffice. Continuing the version numbers from OpenOffice.org, LibreOffice 3.3 was released in January 2011 and version 4.0 was released in August 2014.

In February 2012, The Document Foundation was incorporated in Berlin as a German Stiftung. You can read more about The Document Foundation at: www.documentfoundation.org.

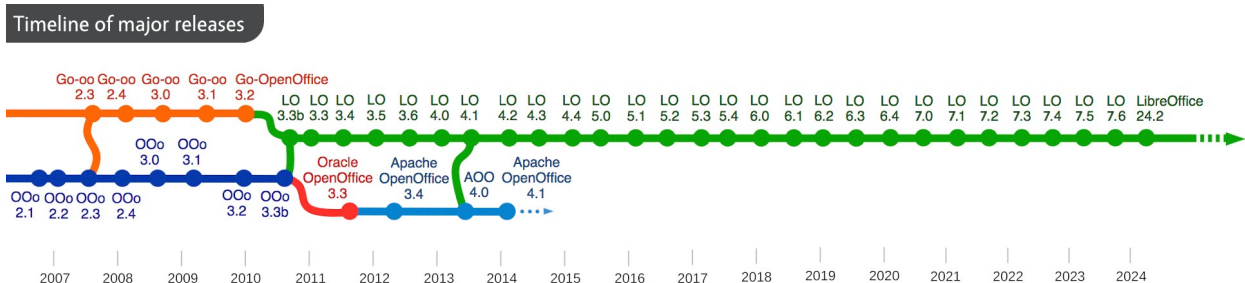

Figure 410: Timeline of major LibreOffice releases

For more detailed history of LibreOffice, visit <https://www.libreoffice.org/about-us/libreoffice-timeline/>

The LibreOffice community

The Document Foundation’s mission is:

“...to facilitate the evolution of the OpenOffice.org Community into a new open, independent, and meritocratic organizational structure within the next few months. An independent Foundation is a better match to the values of our contributors, users, and supporters, and will enable a more effective, efficient, transparent, and inclusive Community. We will protect past investments by building on the solid achievements of our first decade, encourage wide participation in the Community, and co-ordinate activity across the Community.”

LibreOffice is key in the drive to provide an office suite that is available to anyone, anywhere, for commercial or personal use, with its open source software license, that has been translated into several languages and runs on all major operating systems. New functionality can be added in the form of extensions.

How to participate in LibreOffice Community?

The LibreOffice community invites contributors in all areas, including translators, software developers, graphic artists, technical writers, editors, donors, and end-user support. Whatever you do best, you can make a difference in LibreOffice. The community operates internationally in all time zones and in many languages, linked through the internet at www.libreoffice.org and www.documentfoundation.org.

To guide new users in all possible activities in the LibreOffice project, please visit <https://whatcanidoforlibreoffice.org>.

How is LibreOffice licensed?

LibreOffice is distributed under both the Mozilla Public License (MPL) 2.0 (www.libreoffice.org/about-us/licenses/) and the GNU Lesser General Public License (LGPL) 3.0+ (www.gnu.org/licenses/lgpl-3.0.en.html).

What is open source?

The four essential rights of open-source software are embodied within the Free Software Foundation family of the GNU General Public License (GPL):

- The right to use the software for any purpose.
- Freedom to redistribute the software for free or for a fee.
- Access to the complete source code of the program (that is, the “blueprints”).
- The right to modify any part of the source, or use portions of it in other programs.

The basic idea behind open source is very simple: when programmers can read, redistribute, and modify the source code for a piece of software, the software evolves. People improve it, people adapt it, people fix bugs.

For more information on Free and Open Source software, visit these websites:

- Open Source Initiative (OSI): www.opensource.org.
- Free Software Foundation (FSF): www.fsf.org.

What are open standards?

An open standard defines a method for accomplishing something that is independent of manufacturer or vendor. In this case, we are discussing open standards which allows competing software programs to freely use the same file formats. HTML, XML, and ODF are examples of open standards documents.

In computing, an open standard meets the following requirements:

- It is well documented with the complete specification publicly available, either free or at a nominal charge.
- It can be freely copied, distributed, and used. The intellectual property of the standard is made irrevocably available on a royalty-free basis.

- It is standardized and maintained in an independent, open forum (also called “standards organization”) using an open process.

What is OpenDocument?

OpenDocument (ODF) is an XML-based file format for office documents (text documents, spreadsheets, drawings, presentations, and more), developed at OASIS (<https://www.oasis-open.org/>), an independent, international standards group. OpenDocument version 1.2 was adopted by the International Standards Organization and named ISO/IEC 26300:2015 standard. In December 2019, ODF 1.3 was approved as a committee specification.

The OASIS OpenDocument version 1.3 specifications are available in the following links:

- Part 1, Introduction:
<https://docs.oasis-open.org/office/OpenDocument/v1.3/OpenDocument-v1.3-part1-introduction.html>
- Part 2, Packages:
<https://docs.oasis-open.org/office/OpenDocument/v1.3/OpenDocument-v1.3-part2-packages.html>
- Part 3, OpenDocument Schema:
<https://docs.oasis-open.org/office/OpenDocument/v1.3/OpenDocument-v1.3-part3-schema.html>
- Part 4, Recalculated Formula (OpenFormula) Format:
<https://docs.oasis-open.org/office/OpenDocument/v1.3/OpenDocument-v1.3-part4-formula.html>

Unlike other file formats, ODF (ISO/IEC 26300:2015) is an open standard. It is publicly available, royalty-free, and without legal or other restrictions; therefore ODF files are not tied to a specific office suite and anyone can build a program that interprets these files. For this reason ODF is important for government agencies, schools and other companies who prefer not to be too dependent on any software supplier.

LibreOffice saves documents in ODF 1.3 Extended by default. LibreOffice can also open and save in earlier versions of the ODF standard, as well as many other file formats, as summarized in this Help page:

<https://help.libreoffice.org/latest/en-US/text/shared/guide/convertfilters.html>

OpenDocument filename extensions

The most common filename extensions used for OpenDocument documents are summarized in Table 34

Table 34: Filenames extensions for OpenDocument files

Document type	Document	Template
Word processing (text documents)	*.odt	*.ott
Spreadsheets	*.ods	*.ots
Presentations	*.odp	*.otp
Databases	*.odb	
Drawings	*.odg	*.otg
Charts	*.odc	
Formulas and equations	*.odf	
Master documents (text documents)	*.odm	*.otm

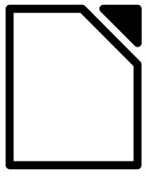

Getting Started Guide

Introduction to LibreOffice

About this book:

If you have never used LibreOffice before, or you want an introduction to all of its components, this book is for you. Anyone who wants to get up to speed quickly with LibreOffice will find this book valuable. You may be new to office software, or you may be familiar with another office suite.

This book introduces LibreOffice and its components:

Writer (word processing)

Calc (spreadsheet)

Impress (presentations)

Draw (vector Graphics)

Math (equation editor)

Base (database)

It also covers features common to all components, including:

Styles

Templates

Clip art galleries

Macros

Printing

About the authors:

This book was written by volunteers from the LibreOffice community.

A PDF version of this book can be downloaded free from: <https://documentation.libreoffice.org>

About LibreOffice:

LibreOffice is the free, libre, and open source personal productivity suite from The Document Foundation. It runs on Windows, macOS, and GNU/Linux. Support and documentation are free from our large, dedicated community of users, contributors, and developers.

You too can get involved with volunteer work in many areas: development, quality assurance, documentation, translation, user support, and more.

You can download the free Community release of LibreOffice from: <https://libreoffice.org/download/>

For commercial use:

You are encouraged to work with a certified LibreOffice professional for your business needs, from deployment or conversion from other office suites, staff training, or custom development needs.

For information on professional support services, <https://www.libreoffice.org/get-help/professional-support/>